

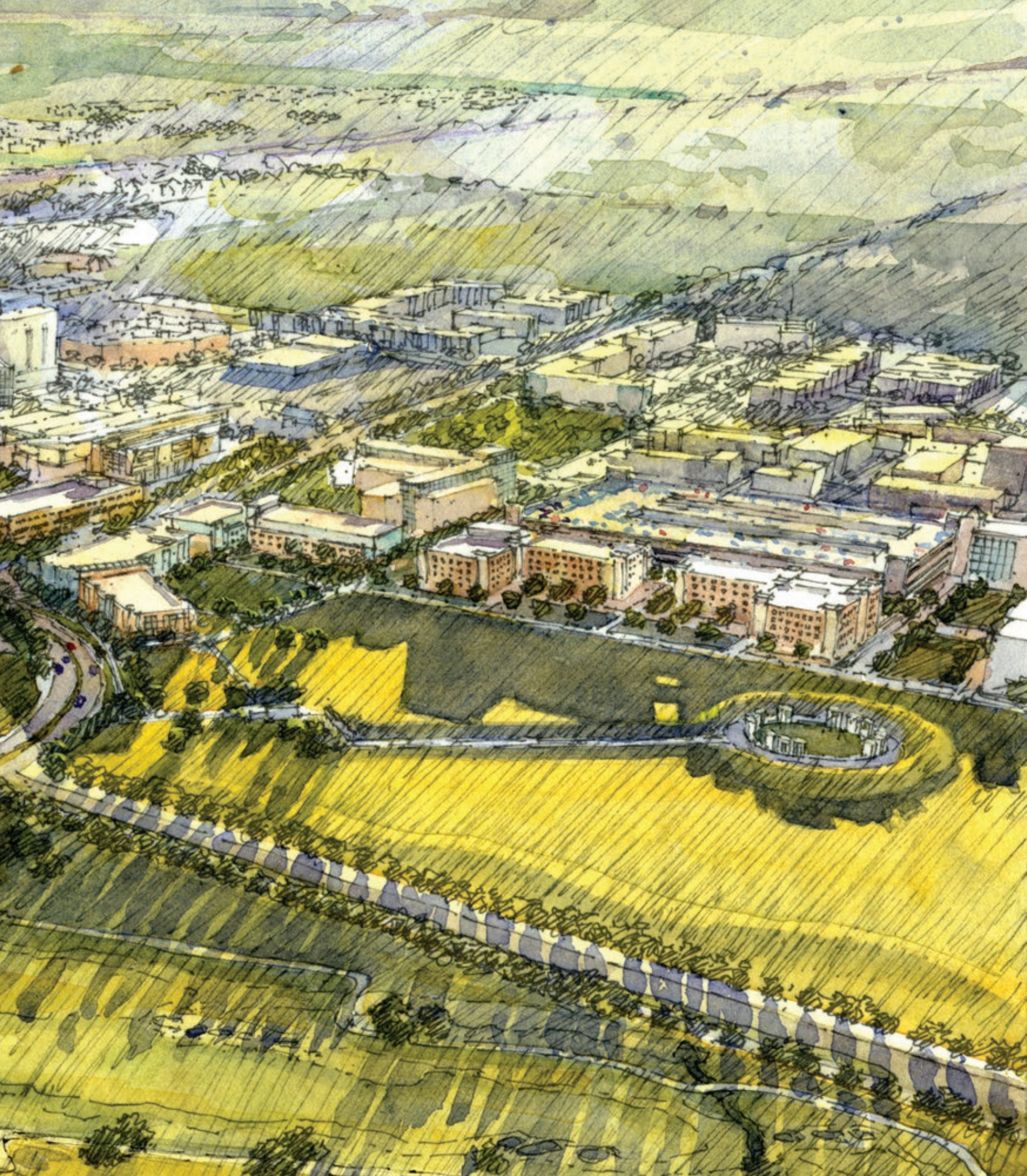

TEXAS A&M UNIVERSITY

2017 CAMPUS MASTER PLAN





CONTENTS

01

Introduction

02

Existing Conditions and Observations

03

Campus Development Plan

04

Mobility and Safety

05

Sustainability and Wellness

06

Campus Guidelines

07

Heritage Conservation

08

Wayfinding and Signage

09

Appendix



Michael K. Young
Texas A&M University President

Texas A&M University has been a place of learning, discovery innovation and impact for over 140 years.

It is home to one of the largest student bodies in the world. It is a place of research and discovery, extraordinary in both quantity and impact. It transforms exceptional young people into citizens of substance, citizens whose contributions shine across the State of Texas and, indeed, across the planet. It is a place that honors our history while shaping our future. It is a place of remarkable people doing remarkable things.

The 2017 Campus Master Plan shapes this sense of place in every sense of that word by re-imagining how our physical environment contributes to our intellectual advancement. From the beginning of this process, our goal has been to enhance the student experience; increase connectivity in terms of both physical connections and interdisciplinary opportunities; and to link our buildings via landscaping and common spaces.

The 2017 Campus Master Plan will be the principal planning document for the campus. It defines and sets the direction for the ongoing development of the campus environment as we move into the future, in both the near and long-term. It integrates the physical systems of campus to enhance our utilization of institutional resources and assets. It is expansive rather than restrictive, allowing for future adaptations which enhance campus. And while this plan is something of a departure from the 2004 Campus Master Plan, it is essential to ensuring that our campus will continue to meet the needs of our community by becoming a premier living-learning laboratory. Our campus will increase its capacity to be this living-learning laboratory by facilitating and showcasing the very best of our teaching, research and extension advancements.

In 2017, we aim to link spaces together, improve how we move through campus safely, preserve our historic spaces and use landscaping and greenspace to inform our future growth. Our focus is on how to best utilize our space and create an environment that aligns with our core values and academic and research priorities. This document provides us with the framework to achieve these goals.

I want to thank my colleagues, Dr. Karan L. Watson, Provost and Executive Vice President and Chief Academic Officer, and Dr. Jerry R. Strawser, Executive Vice President for Finance and Administration and Chief Financial Officer, for their support and counsel throughout this process. Likewise, I appreciate the time dedicated to this effort by our two advisory committees – the Council of Deans and the Council on Built Environment – and by our twelve focus groups. Every member of these groups ensured that we balanced the operational needs of campus with our academic vision. Additionally, I wish to thank our many community constituents who participated via open-houses, surveys, and meetings to provide us with much needed input.

Finally, I would like to commend the leadership of Dr. Jorge Vanegas, Dean of the College of Architecture, and Ms. Lilia Gonzales, University Architect, who co-chaired the Campus Master Planning process. Without their dedication and commitment this project would not have come to fruition. Their knowledge and willingness to advocate for the campus is greatly appreciated.

This new Campus Master Plan sets our direction and points us to the future.

A handwritten signature in black ink that reads "Michael K. Young". The signature is fluid and cursive, with a large, stylized initial 'M' and 'Y'.

Michael K. Young
Texas A&M University President



Lilia Y. Gonzales, '94
Campus Master Plan Co-Chair
University Architect



Dr. Jorge Vanegas
Campus Master Plan Co-Chair
Dean, Texas A&M College of
Architecture

The 2017 Campus Master Plan for Texas A&M University represents the culmination of many months of work by many people across many disciplines.

This plan brings together a diversity of thought around six broad and far reaching focus elements that were used to guide and shape the Campus Master Plan: Campus Development Plan, Mobility & Safety, Sustainability & Wellness, Campus Guidelines, Heritage Conservation, and Wayfinding & Signage.

Each of these focus elements identifies and addresses comprehensive and essential components of the campus, and the 2017 Campus Master Plan brings them together as pieces of a cohesive puzzle. The plan offers a roadmap, rather than just a checklist, allowing Texas A&M University to utilize its current valuable campus assets and resources to their fullest extent, while allowing for future developments to the campus. The plan also identifies heritage buildings, green spaces, and vistas for conservation as a key part of the campus environment. From the beginning, an aspirational goal of the plan was to increase the connectivity of the campus through the built environment, green spaces, and pedestrian oriented paths. Guidelines pertaining to the landscape and built environment strive to ensure a cohesive campus through enduring values, rather than just historicist, prescriptive guidelines, or ephemeral trends. Furthermore, the identification of character zones allows for distinct aesthetics that have emerged over time to continue within these zones and allows us to bridge common elements such as materiality, landscape amenities, and signage to create a consistent palette to unify the look and feel of the campus.

This 2017 Campus Master Plan was developed with input from a variety of sources, including extensive input from the campus community and beyond, through a rigorous campus engagement. Twelve focus groups were used to capture this input, which covered specific areas, design elements, or operational matters on campus with a broad representation from campus administration, university departments, student government, and university committees. In addition, several meetings were conducted with the Executive Committee, the Council of the Deans, and the Council for the Built Environment for leadership and assurance that the plan was developed with full support from faculty, staff, and the student senate. Overall, more than forty collaborative workshops were held, covering proposed scenarios of campus development, identifying the direction that planning should take, and reaching consensus for making changes to the master plan. A website was created to share information throughout the planning process with every presentation available for view, and Open House sessions were conducted to get direct feedback from students, faculty and staff on existing conditions of the campus, as well as on proposed solutions.

We are very proud to have had the opportunity to co-chair this effort, and to participate in this process. We are thankful for the commitment, active participation, excellent contribution, and hard work of all those who participated. We are particularly grateful for the many thoughtful ideas, questions, and suggestions that the campus community and other stakeholders offered.

Dr. Jorge Vanegas
Dean, Texas A&M College of
Architecture

Lilia Y. Gonzales, AIA, LEED AP
University Architect





01

INTRODUCTION

- Introduction
- Key Objectives
- The Six Focus Elements
- Engagement and Planning Process
- Past Planning Initiatives
- Goals and Guiding Principles
- Ongoing and Future Planning Efforts
- Document Organization
- Definitions and Terms

"Texas A&M University is dedicated to the discovery, development, communication, and application of knowledge in a wide range of academic and professional fields. Its mission of providing the highest quality undergraduate and graduate programs is inseparable from its mission of developing new understandings through research and creativity. It prepares students to assume roles in leadership, responsibility and service to society.

Texas A&M assumes as its historic trust the maintenance of freedom of inquiry and an intellectual environment nurturing the human mind and spirit. It welcomes and seeks to serve persons of all racial, ethnic and geographic groups as it addresses the needs of an increasingly diverse population and a global economy. In the 21st century, Texas A&M University seeks to assume a place of preeminence among public universities while respecting its history and traditions."

-Texas A&M University Mission Statement



The 2017 Texas A&M University Campus Master Plan builds on the foundation of the 2004 Campus Master Plan's purpose to foster a physical environment that stimulates intellectual growth, supports high quality teaching, learning and research, and encourage interaction, cross-disciplinary cooperation, and scholarly exchange.

In mid-2015, Texas A&M University at College Station (Texas A&M University, Texas A&M, or the University) embarked on a comprehensive Campus Master Plan. The 2017 Campus Master Plan (the CMP, or the plan) focuses on building a new campus framework and open space network to enhance and connect underdeveloped areas of the campus. Mobility systems are planned to better support and serve pedestrians and thus increase safety and the experience of the campus. Campus guidelines are re-imagined and re-shaped by enduring values rather than prescriptive, historicist guidelines or ephemeral trends. The heritage conservation plan has been re-evaluated and incorporates updated guidelines that address practices for renovation and treatment of heritage buildings. In addition to addressing the built environment, the plan includes a comprehensive signage and wayfinding design package and a comprehensive overview of sustainability concepts.

As the 2004 Campus Master Plan did, the 2017 Campus Master Plan seeks to align with the University's Strategic Plan, *Vision 2020: Creating a Culture of Excellence* and the *Academic Master Plan*. *Vision 2020* articulates Texas A&M's bold recognition of necessary institutional evolution required to achieve its mission as a land, sea, and space grant institution of global preeminence through twelve imperatives that advance the existing mission and unique heritage of Texas A&M. *Vision 2020* guides strategic planning, budgeting, and administrative priorities. The *Academic Master Plan* builds on previous successes, recognize areas for attention, and reaffirms Texas A&M's commitment to *Vision 2020*.

The 2017 Campus Master Plan team was charged with developing a plan that builds upon prior planning efforts, incorporating the many projects and improvements completed since 2004, as well as those currently underway. During this year-long process, the planning team gathered data, observed and analyzed campus life, and developed concepts and approaches for change. This was followed by developing and testing multiple precinct studies in order to create an updated Campus Development Plan. Campus Guidelines, policies and implementation strategies were created to reinforce the vision of the Campus Development Plan.

The core of the planning effort was active and inclusive participation from University leadership, faculty, staff, students, alumni, trustees, neighbors, and local officials working in collaboration with a consultant team of architects, planners, landscape architects, engineers, and sustainability specialists. By collecting input from a wide range of stakeholders, the Campus Master Plan integrates a cross-section of experiences and ideas pertaining to the future development of the campus. The outcome of this process is a Campus Master Plan that places emphasis on the campus experience, reinforces cohesion and consistency, and provides a fresh vision for long-range development over the next 20 years and beyond.



Key Objectives

As provided by the University Leadership, and reinforced by the campus stakeholders, there are the three key objectives that drive the 2017 Campus Master Plan. These objectives have been reaffirmed over the course of deep engagement with the campus community.

- **Enhance the Student Experience:** Develop Texas A&M's campus into a vibrant, active, and attractive place where students can live, learn, socialize, and succeed.
- **Improve Campus Connectivity:** Through the improvement of both physical connections and interdisciplinary connections, foster intellectual exchange and social interaction.
- **Integrate the Built Environment:** Knit the campus together through a cohesive landscape and ground plane to enhance the image of the campus and its sense of place throughout.

The 2017 Texas A&M University Campus Master Plan will have far-reaching and long-lasting impacts to improve, enhance and modernize the character of the University, while still remaining true to the mission, and core values of Texas A&M University.



Military Walk - Cadets and Student

Focus Elements

The 2017 Campus Master Plan is organized by six Focus Elements. Individually the Focus Elements dive deeper into specific topics, but fully support the key objectives, goals and principles of this plan. The planning team worked with University leadership, faculty, staff, students, alumni, trustees, neighbors, to identify the challenges, issues, approach and solutions for each of the Focus Elements. These focus elements serve as the organization of this document, and the scope of work included in this plan.



Campus Development Plan

A review and analysis of existing planning efforts undertaken by the University since the adoption of the Campus Master Plan in 2004. This includes the adopted and proposed District Plans, and other planning efforts.



Mobility and Safety

Evaluation of current campus access and circulation along with a new plan emphasized by the pedestrian experience, alternate mobility opportunities, future garage locations and connections to the community.



Sustainability and Wellness

A comprehensive approach to campus sustainability including topics on the environment, economics and equity. To support greater longevity and flexibility, the planning effort identified 9 major themes.



Campus Guidelines

A comprehensive review of the current guidelines, and recommended additions, deletions and modifications for architectural and landscape components.



Heritage Conversation

An updated inventory of heritage resources including buildings, open spaces and site amenities. This inventory is supplemented with a comprehensive update to the Heritage Building Guidelines.



Wayfinding and Signage

A signage & wayfinding plan that delivers a framework for implementing future on-campus signage through an integrated-system approach to vehicular and pedestrian directional signage.

ENGAGEMENT AND PLANNING PROCESS

A major initiative within the 2017 Campus Master Plan was to provide a transparent and inclusive process throughout the entire process. From the start, the University was committed to engaging faculty, staff, students, alumni, trustees, and neighbors, as well as local officials to gather insights about assets and opportunities for the Campus Master Plan. The process elevated primary decisions with potential solutions to the leadership group after developing consensus at the working group level. A consistent exchange with leadership regarding progress and opportunity was intrinsic within each phase.

To guide the planning process, Texas A&M University established twelve focus groups that covered specific areas, design elements or operational matters of the campus. These groups had broad representation from campus administration, university departments, student government and various university committees. *(For a complete list of focus group members, see page xx in the appendix.)* These collaborative workshops held on campus were the primary vehicle for the planning work. Each workshop included substantive work sessions to review and evaluate proposed new solutions and options; make decisions about directions the planning should take; and build consensus for making changes to the master plan.

Meetings with the Executive Committee, Council of the Deans, and Council for the Built Environment provided leadership and assurance that the plan had the full support from faculty, staff and the student senate that is required for implementation. The planning team also met with community and regional representation including the Bryan/College Station Metropolitan Planning Organization (MPO) and Intergovernmental Committee (IGC) in order to ensure coordination and collaboration with campus partners. The plan was also previewed by the Texas A&M University System Chancellor and Board of Regents.

In addition to the on-campus workshops, open house sessions for Students, faculty and staff were held to both gain insight into existing conditions of the campus, and to react to proposed solutions. A website was created to share information throughout the planning process at <http://campusplan.tamu.edu/>. All process information can be located here.

The process began in August 2015 with data gathering, a campus visit and a kick-off workshop to observe the campus and its users. Over 50+ Campus and Community Workshops were held between November 2015 and October 2016. The first round of Workshops focused on Campus Observations and Analysis through a series of interactive sessions which provided the planning team with an understanding of the challenges and opportunities of the campus. The second round of focus groups focused on introducing the approach to each of the focus elements. The third round of focus groups focused on proposed solutions and recommendations for each of the six focus elements included in the report.

From October-December 2016, draft reports were presented for feedback to the focus group members. The document was updated and reviewed by the Executive Committee prior to developing the final plan documents for the Board of Regents meeting held February 2017. The Campus Master Plan was officially adopted in May 2017 as the primary planning document for the University.

The process intends to elevate primary decisions with potential solutions to the leadership group after developing consensus at the working group level.

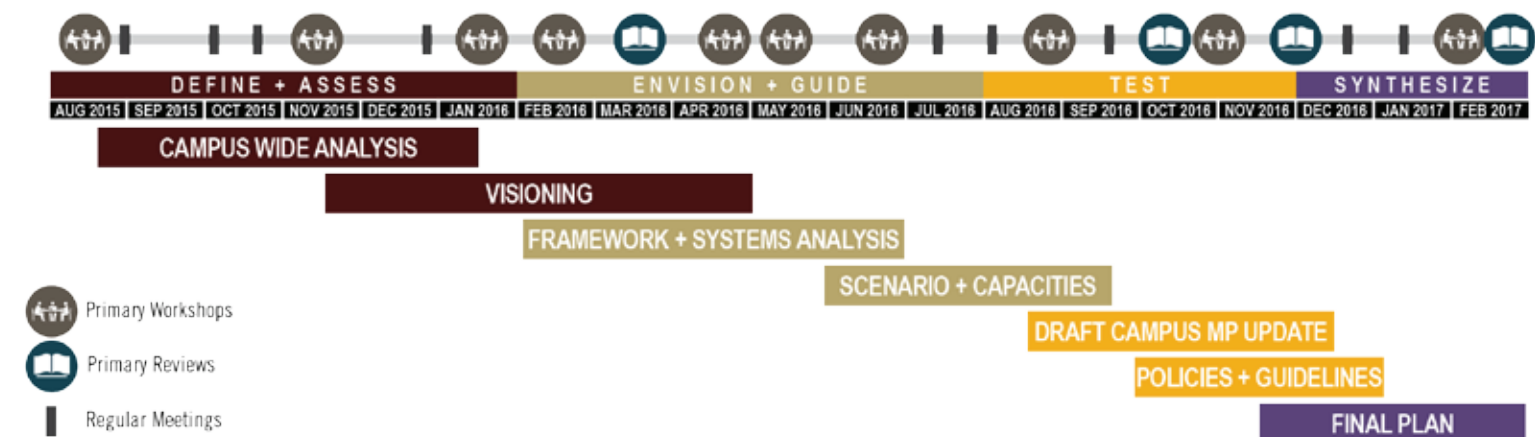

Campus and Community Engagement

Orchestrate

Co-Chairs

Dr. Jorge Vanegas
Ms. Lilia Gonzales

Support

Information Requests

University Architect
Transportation Services
Utilities and Energy Services
Student Affairs
Academics

Direct and Advise

Executive Committee

President
Provost
VP for Finance and Administration

Advisory Committees

Council of the Deans
Council on the Built Environment

Focus Groups

Landscape Guidelines
Design Guidelines
Sustainability
Housing and Dining
Research Park
Hensel Park
Transportation and Circulation
Infrastructure
Preservation
Voices of the Campus
Signage and Wayfinding
Health Sciences Campus

Campus and Community

Open Houses
Website
Texas Transportation Initiative
Metropolitan Planning Organization
Intergovernmental Committee



Process Engagement

From Top Left to Bottom Left: Campus Tour with Planning Team and Campus Stakeholders, Focus Group Session SWOT Exercise, Focus Group Session Planning Discussion, Faculty, Staff and Student Open House Session

More than 300 participants contributed ideas and comments to shape the development of the Campus Master Plan.

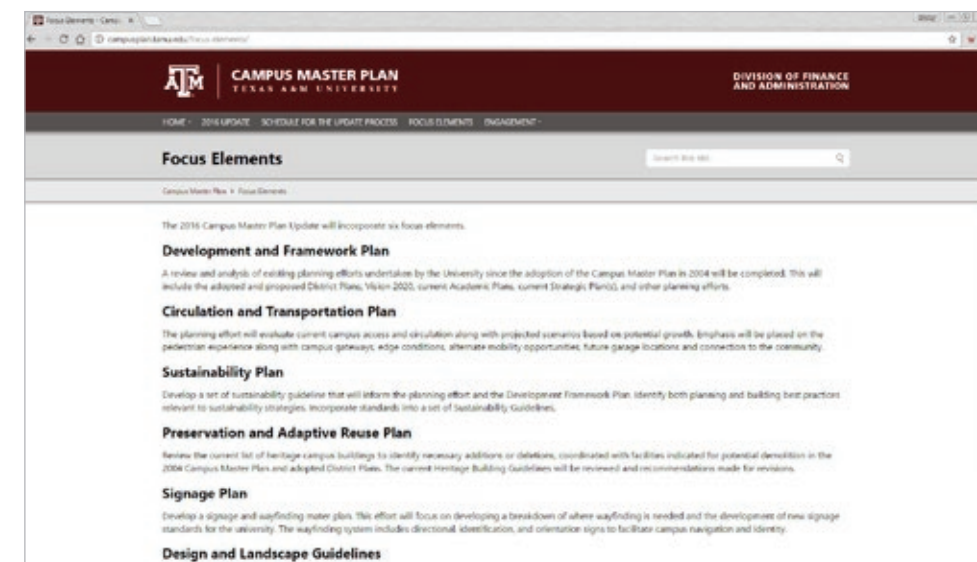

Campus Master Plan Website (<http://campusplan.tamu.edu/>)

PAST PLANNING INITIATIVES

As a comprehensive planning effort, the 2017 Campus Master Plan builds upon prior planning efforts and incorporates projects and improvements completed since 2004, as well as those currently underway through district plans.

2004 Campus Master Plan

Texas A&M University's Campus Master Plan was adopted in 2004 as a strategic and tactical guide for the physical development of the campus. The 2004 Campus Master Plan provided a roadmap and a planning ethic for the future. The plan proposed a re-orientation of campus development policy in order to bring the physical environment into complementary alignment with the academic and social mission of the University. It sought to accomplish this through two primary means: growth management and improved quality of the physical environment.

Many elements from the 2004 Campus Master Plan such as the Civic Structure, Landscape Plan, Development Density, and others have corresponding elements in the 2017 Campus Master Plan that have been modified to take into consideration current needs and influences on the campus. For example, the 2004 Landscape Plan is reflected in the 2017 Open Space Network, both defining and reinforcing the public realm to enhance the campus experience.

The 2017 Campus Master Plan is the principal planning document for Texas A&M University's College Station campus which defines and sets direction for the ongoing development of the campus environment. The 2004 Campus Master Plan remains a relevant reference but is superseded by the 2017 Campus Master Plan. As campus development progresses, the relevance of the 2004 Campus Master Plan will continue to decrease, but it remains a useful reference to understand the history of development on campus along with the goals and influences that have impacted the built environment.



Ross Street converted to a limited access roadway as a result of the 2004 Campus Master Plan



Projects Completed since 2004
From Left to Right: Underpass at Wellborn Road and Old Main Drive, Military Walk

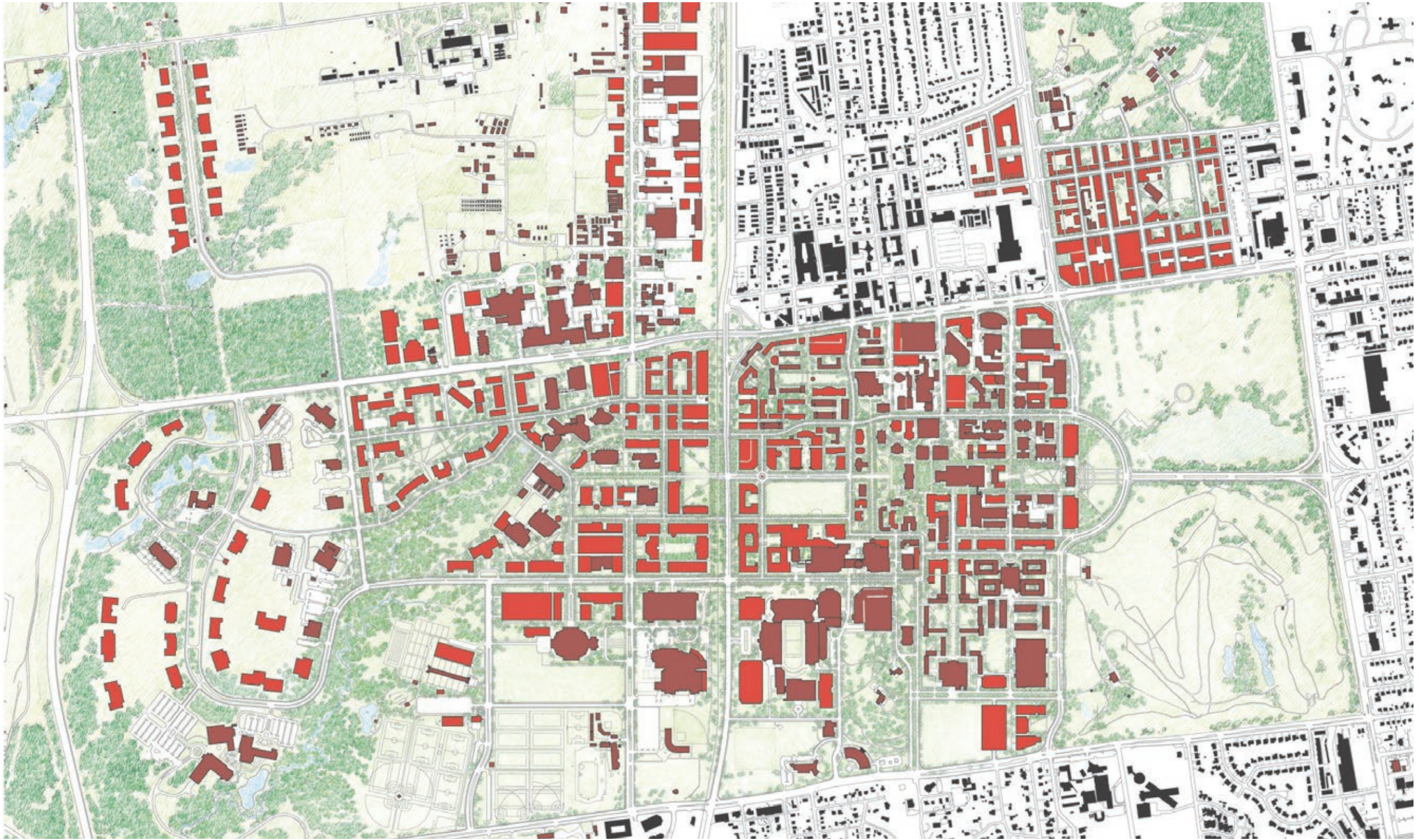

2004 Campus Master Plan - Architectural Plan

District Planning

In the intervening years since the 2004 Campus Master Plan, the University has undertaken a series of District Plans to provide more detailed planning focused on specific areas and academic programs on campus. These have often been led by individual departments or colleges focused on their specific programmatic and facility needs.

While these have served as a good tool to further define the campus environment in smaller planning areas and for distinct academic programs, they have led to a patchwork of planning that is not well integrated across the campus as a whole. This has resulted in varying levels of user experience and quality of the campus environment.

A primary objective of the 2017 Campus Master Plan has been to build upon these District Plans while providing a strong framework to integrate them across the campus, and establish a consistent level of quality and parity for the campus community. The District Plans continue to be relevant references for ongoing development, but the overall campus environment will be guided by the 2017 Campus Master Plan to ensure the physical experience of the Texas A&M University is integrated to reflect a holistic message, image and mission.

Moving forward, District Plans will be replaced with 'Facilities and Programming Plans'. These plans seek to bridge the gap between specific departmental and/or academic needs with the high-level approach to development within the 2017 Campus Master Plan. All Facilities and Programming Plans should reinforce the concepts, align with the guidelines and follow the implementation strategies included in the Campus Master Plan. Facilities and Programming Plans, commissioned by Texas A&M departments or colleges, should first and foremost address academic or administrative program growth and needs. Any plans for change to the physical environment of the campus as a result of program needs (ie. placement of new buildings/ additions, linkages and connections, open spaces, roadway alterations, etc.) should be derived directly from the 2017 Campus Master Plan.



Health Sciences Campus Master Plan, FKP Architects Inc. - 2008



The Gardens at Texas A&M, Douglas F. Welsh - 2013



Athletics Facilities District Plan, Populous - 2013

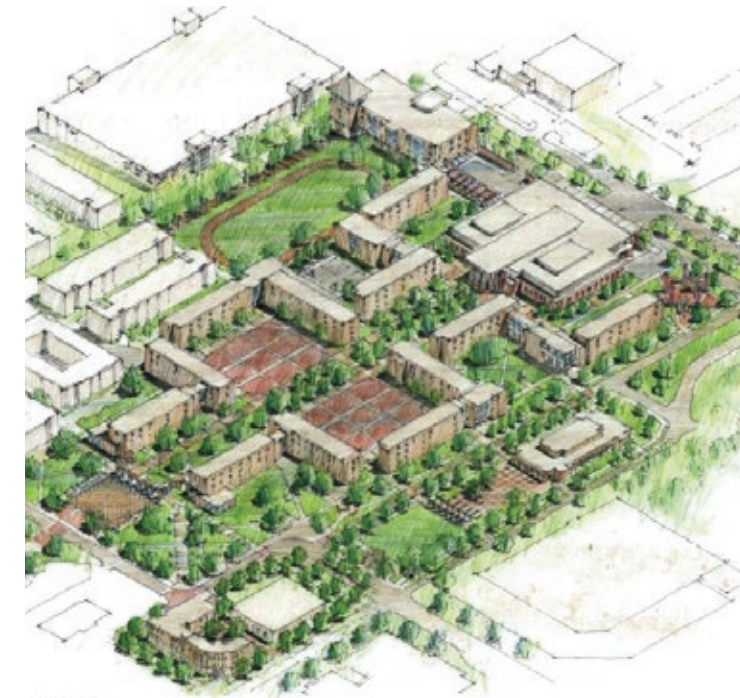

Corps of Cadets District Plan, Barnes Gromatzky Kosarek Architects - 2012

District Plan Mosaic

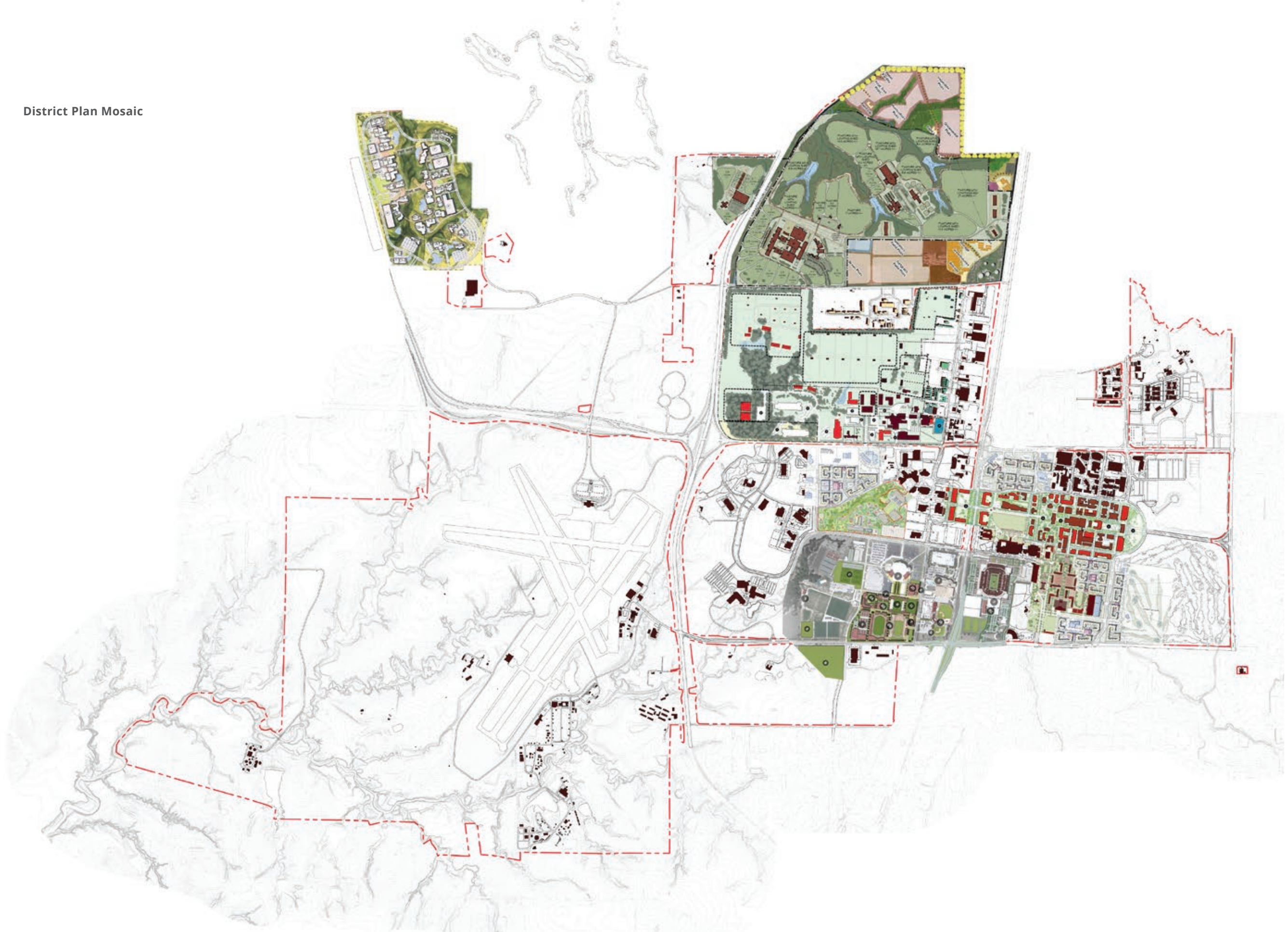

The 2017 Campus Master Plan is the principal planning document for Texas A&M University's College Station campus. As the primary source, it defines and sets the direction for the ongoing development of the campus environment that supports the mission, core values and heritage of the institution.

A master plan physically expresses the mission of the University. The plan must be forward looking and, at the same time, based on today's pragmatic realities. It must balance a visionary and realistic approach to the growth and future development of the campus. Building on the University's existing traditions and strengths, the 2017 Campus Master Plan provides opportunities to enhance Texas A&M University in order to move to the next level and become the leading public research university in the United States.

The 2017 Campus Master Plan is based on an understanding of the strategic and academic visions for the University. It suggests a path forward based specified goals and principles that, along with individual strategies outlined in the Plan, will help advance Texas A&M's mission and core values: Excellence, Integrity, Leadership, Loyalty Respect, and Selfless Service.

While the goals, principles and values of the master plan may remain consistent overtime, the physical implementation of these may need to evolve to meet current and anticipated needs. The 2017 Campus Master Plan is equipped with the ability to adapt with the changing needs of the institution.



The statue of Sul Ross stands in front of the Academic Building as Spring arrives and the trees begin to bloom. ►





Goals of the 2017 Campus Master Plan

Through engagement with campus stakeholders, University leadership and the campus community at large, it became clear that the goals established in the 2004 Campus Master Plan remain relevant to the campus today. **To focus and ground the planning process, the 2017 Campus Master Plan retains the goals set forth by the 2004 Campus Master Plan.** The 2017 Campus Master Plan uses these goals as a baseline while taking into consideration current influences and needs.

- Reinforce Campus Identity
- Reinforce Campus Community
- Establish Connectivity
- Create Architecture that Contributes Positively to the Campus Community
- Promote Spatial Equity & Appropriateness
- Establish an Accessible, Pedestrian Campus
- Promote Sustainability
- Develop a Supportive Process

◀ An Aggie student studies underneath the Century Tree in Academic Plaza

Guiding Principles of the 2017 Campus Master Plan

Active planning must be guided by a consistent set of values and principles, against which all concepts and proposed solutions are measured. These guiding principles are the foundation of the plan and guide the development and concepts.

The guiding principles of the 2017 Campus Master Plan translate the aforementioned Key Objectives and Goals into specific areas of focus for this planning effort. The guiding principles tie together the aspirational vision of the campus determined by the campus stakeholders and University leadership.

From the process of working with campus stakeholders, University leadership, and the campus community at large, the planning team developed nine guiding principles to lead the 2017 planning effort based on its understanding of Texas A&M's values, goals and objectives. These principles or “drivers” address observed deficiencies or needs while meeting the stated goals, principles, and vision of the University.

<p>1 Use Open Space Network as a Basis for New Development: <i>Campus development and growth will be guided by the creation of new open space and the enhancement of existing open space to support an enriched campus experience.</i></p>	<p>2 Utilize the Campus as a Living Laboratory: <i>Through the collaboration of students, faculty and staff, the campus offers opportunities to be used as a space, site or subject supporting Texas A&M's academics and research.</i></p>	<p>3 Approach Sustainability Comprehensively: <i>Accommodate an inclusive incorporation of sustainability that equally supports the many aspects of the campus experience: social, cultural, wellness, economic and the built environment.</i></p>
<p>4 Plan the Campus Holistically and Incrementally: <i>Plan comprehensively to create a great campus, seeing the integrated whole versus a series of isolated hubs. Individual systems and programs are incorporated to support the broader context of the entire campus experience.</i></p>	<p>5 Foster Interaction through Campus Forums: <i>A great research university requires a dynamic community that provides exposure to a wide range of perspectives, and generates the encounters and interactions. Interaction leads to new insights and discovery.</i></p>	<p>6 Conserve Heritage Buildings and Spaces: <i>Build upon the strong campus traditions, both the built physical environment and programmatic elements, that celebrate the past while also encouraging creativity, diversity and innovation on the campus.</i></p>
<p>7 Strengthen Campus Cohesion to Create Parity: <i>Character Zones allow distinct aesthetics that have emerged over time in specific zones to continue while identifying the necessary elements that allow the campus to maintain a consistent impression of cohesiveness across its extents.</i></p>	<p>8 Focus Mobility Planning on the Pedestrian: <i>The safety of campus users is the priority in decision making for mobility planning. The pedestrian-priority zone is a planning tool for future development to prioritize the pedestrian connections over the vehicular access.</i></p>	<p>9 Create Opportunities to support the Campus Brand: <i>Envision the campus along its edges and thresholds, as the public and community does, to present a clear, cohesive and welcoming identity in support of fluid engagement.</i></p>

Ongoing and Future Planning Efforts

The diagram on the facing page describes the relation of past, current and future planning efforts to the 2017 Campus Master Plan.

Moving forward, District Plans will be replaced with 'Facilities and Programming Plans'. These plans seek to bridge the gap between specific departmental and/or academic needs with the high-level approach to development within the 2017 Campus Master Plan. All Facilities and Programming Plans should reinforce the concepts, align with the guidelines and follow the implementation strategies included in the Campus Master Plan. Facilities and Programming Plans, commissioned by Texas A&M departments or colleges, should first and foremost address academic or administrative program growth and needs. Any plans for changes to the physical environment of the campus as a result of program needs (ie. placement of new buildings/additions, linkages and connections, open spaces, roadway alterations, etc.) should be derived directly from the 2017 Campus Master Plan. Currently, the Corps of Cadets is currently undergoing a Facilities and Programming Plan to study how future enrollment growth will affect their facilities. In addition, Residence Life is completing a Northside Housing Renovation Study to study the rehabilitation of existing housing stock. A similar study for the Southside Housing precinct is recommended.

The University has and continues to undertake planning efforts that deal with aspects or topics of the campus closely, but not solely, related to the built environment. Two examples of these additional planning efforts include the 2010 Sustainability Master Plan and the 2015 Bicycle District Strategic Plan. While these and other efforts have a direct impact on the built environment, they also encompass operational, administrative and other aspects of the campus experience that relate to a greater context than covered by the 2017 Campus Master Plan. These types of planning studies will continue to provide topic specific overlays and supplements to the 2017 Campus Master Plan into the future. It is critical to maintain ongoing integration between planning supplements and the Campus Master Plan on a continuing basis to reflect

these new influences and the changing campus environment. This will assist in ensuring that Campus Master Plan remains a relevant reference and tool for the improvement of the campus environment.

To support an evolving Campus Master Plan, Texas A&M University will have to increase the frequency of its campus-wide planning efforts. While a definitive time frame for this increased frequency is influenced by a host of varying factors, a good starting point is for the institution to undertake minor updates approximately every five years to incorporate any precinct, system, service or topical planning efforts that have occurred in the intervening years.

As subsequent planning efforts occur, such as Facilities and Programming Plans, consideration will be given to their impact on the campus-wide context. Efforts that cause minor revisions to the campus-wide context may be incorporated into the Campus Master Plan during the normal update cycle. Major changes which affect the spacial anatomy of the campus, such as the pattern of public spaces, the framework schema and open space network, and the campus' relationship to its surrounding community, shall have as part of their effort a requirement to update the Campus Master Plan. The Office of the University Architect along with the Council for the Built Environment serve as the arbiters for the determination of what planning efforts constitute minor or major revisions to the Campus Master Plan. All updates and comprehensive efforts should align with the University's strategic and academic planning.

Campus Planning Documents

Past Campus-Wide Planning Efforts

2004 Campus Master Plan

The 2004 Campus Master Plan remains a relevant reference but is superseded by the 2017 Campus Master Plan. As the development of the campus progresses in the future, the relevance of the 2004 Campus Master Plan will continue to decrease, but it remains a useful reference to understand the history of development on campus along with goals and influences that have impacted the built environment in the past.

Vision 2020

Academic Master Plan

Vision 2020 and the Academic Master Plan express Texas A&M's vision to become a top ten public university. These plans are the foundation for the future planning of the University.

Campus Planning Documents

- 2017 Campus Master Plan
- Completed Planning Study/Document
- Ongoing Planning Study/Document
- Future Planning Study/Document

Past District Planning Efforts

AgriLife District Plan

Historic Core District Plan

Health Science Center Campus Plan

Equine Initiative District Plan

Gardens and Greenway

Corps of Cadets District Plan

Health-Kinesiology District Plan

Athletics District Plan

CVMBS District Plan

West Campus Housing Study

Proposed
25x25 Engineering District Plan

The District Plans continue to be relevant references for ongoing development but the overall campus environment will be directed by the 2017 Campus Master Plan.

2017 Campus Master Plan



The 2017 Campus Master Plan is the principal planning document for Texas A&M University's College Station campus. As the primary source, it defines and sets the direction for the ongoing development of a campus environment that supports the mission, values and heritage of the institution.

Ongoing Planning Efforts

Facilities and Programming Plans

Corps of Cadets Facilities and Programming Plan

Northside Housing Renovation Study

Campus Systems and Standards

2017 Sustainability Master Plan

Comprehensive Stormwater Master Plan

2015 Bicycle District Strategic Plan

Strategic Plans

Examples of Recommended Planning Efforts

Facilities and Programming Plans

Innovation District in the Texas A&M University Research Park

Campus Systems and Standards

Guidelines for Maintenance of Historic Buildings

Updated Texas A&M Facility Design Standards

Updated Campus Site Furnishings and Hardscape Standards

Strategic Plans

DOCUMENT ORGANIZATION

The remainder of this document is organized into chapters that align with the six Focus Elements, and Existing Conditions and Observations. Acknowledgments and project processes are located in the Appendix.

Document Highlights



Sustainability is woven into every aspect of the 2017 Campus Master Plan. Each chapter begins with a green tag that introduces the sustainability concepts that are included within the chapter. Chapter Five, Sustainability and Wellness is the central location for sustainability concepts in the document, but each focus element has sections within it that relate back to the sustainability concepts inherent in this plan. Within the chapters, the specific sections that relate to sustainability are called out using the green globe icon, pictured to the left.



Dining is highlighted in multiple sections and chapters using the cutlery icon to the left. Dining is an important social aspect for campus users and entails many pieces to create a successful program. In the Campus Master Plan, Dining is addressed in terms of location (existing and suggested) and connection to sustainability (waste management, healthy food options and quality of life for campus users).



Seal located at Military Walk and Academic Plaza

Definitions and Terms

For the purpose of this document, the following terms can be defined as follows:

Campus Development Plan Terms

Campus Development Plan: A strategy for future campus development through a series of thoughtful interventions informed by existing conditions, prior planning efforts, and substantial campus engagement.

Floor Area Ratio (FAR): A measure of building density, defined as the ratio of total building square footage to land area.

Facility Condition Index (FCI): Compares the cost to modernize a building's primary systems with the cost to replace it with a new building.

Density: A term used to measure the concentration buildings and their associated FAR located within a given area.

Main Campus: For the purpose of this document, '*main campus*' refers to the land bordered by Texas Avenue, University Drive/Raymond Stotzer Parkway, George Bush Drive, and Harvey Mitchell Parkway, in comparison to other remote areas within the planning boundary such as Health Sciences Campus, Hensel Park and the land north of Raymond Stotzer Parkway.

Civic Structure: From the 2004 Campus Master Plan, a central spine that connects the campus from east to west.

Framework Schema: A conceptual diagram that identifies the key linkages and connections across campus.

Open Space Network: Series of open spaces on campus comprised of a variety of scales, uses and physical elements that define a diverse set of landscape typologies.

Character Zone: smaller areas of the campus that focus solely on the physical campus elements within their boundaries such as density, siting, massing and materiality.

Precinct: Smaller areas of campus that combine academic program elements and physical campus elements together, to plan smaller areas of the campus in more detail.

District Plans: Led by individual departments or colleges focused on their specific programmatic and facility needs, these planning efforts provide more detailed planning that primarily focused on specific areas and academic programs on campus.

Facilities and Programming Plans: Commissioned by Texas A&M departments or colleges, should first and foremost address academic or administrative program growth and needs. Any plans for changes to the physical environment of the campus as a result of program needs should be derived directly from the 2017 Campus Master Plan.

Forum: A place, meeting, or medium where ideas and views can be exchanged. Forums can be interior, exterior, or even non-physical.

Albritton Bell Tower ▶



Mobility and Safety Terms

ADA/Accessible: Building entrances and routes designed for access by persons in wheelchairs or with motion disabilities, as established by the 1990 Americans with Disabilities Act.

Bikeshare: The rental of bicycles at unattended stations for short term use.

Circulator: A mass transit vehicle, such as a shuttle bus, providing frequent service on an established route.

Dismount Zone: A pedestrian area where the use of unmotorized vehicles is prohibited. Riders must dismount and walk their bicycles, or carry their skateboards.

Grade Separation: A method of aligning a junction of two or more surface transport axes at different heights (grades) so that they will not disrupt the traffic flow on other transit routes when they cross each other.

Limited Access Roadway: Segments of existing roadways that are closed to private vehicles or limit access to private vehicles during certain times of the day. These roadways are accessible to credentialed service and emergency response vehicles.

Pedestrian-Priority Zone: An area of campus that gives priority to pedestrians limiting a majority of vehicle traffic with the exception of transit, service and emergency vehicles.

Bicycle Lane: A portion of the roadway that is designated for bicycle users only.

Road Table: A raised portion of road broad enough to raise a vehicle's entire wheelbase, used to slow approaching traffic.

Sharrow (or Bicycle Route): Shared lane for both vehicular users and bicyclists due to right-of-way constraints.

Buffered Bicycle Lane: Traditional bicycle lanes on the shoulder of the road that are separated from the vehicular lane (or parking lane) by a designated buffer space.

Multimodal: The use of multiple modes of travel to accomplish a trip, such as a commute using both bus service and bicycling.

Multi-Use or Shared Path: Sidewalks or pathways for pedestrians and bicyclists that are separated from the vehicular lanes with an elevated surface.

Roundabout: A type of traffic circle designed to allow traffic to flow without stopping before entering the circle.

Traffic Calming: The deliberate slowing of traffic on a road by the use of speed bumps, road tables, or other obstructions.

Vegetative Buffer: A grassy or landscaped median separating directions of travel on a road, or similar verge separating a road and sidewalk.

Landscape Terms

Greenspace: An area of grass, trees, or other vegetation set apart for recreational or aesthetic purposes, usually conveying a particular character – park, woodland, lawn – as opposed to interstitial grassy or landscaped areas adjacent to buildings.

Landscape: The outdoor environment where softscape (vegetative materials) and hardscape (constructed materials) elements come together through design to form the campus' natural outdoor setting.

Hardscape: Man-made features used in landscape architecture, such as pathways, walls, or plazas.

Softscape: Areas comprised of horticultural elements such as grass, soil, flowers, trees, shrubs, and other vegetation. Softscape can be designed and manicured, or refer to natural elements.

Native Species: Plants that live and grow naturally in a particular region or ecosystem without direct or indirect human intervention.

Adaptive, or "Naturalized" Species: Plants that were introduced long ago but are able to reproduce and thrive without human intervention.

Heritage Conservation Terms

Conservation: The process through which the material, historical, and design integrity of humanity's built heritage are prolonged through carefully planned interventions.

Preservation: Focuses on the maintenance and repair of existing historic materials and retention of a property's form as it has evolved over time.

Rehabilitation: Acknowledges the need to alter or add to a historic property to meet continuing or changing uses while retaining the property's historic character.

Restoration: Depicts a property at a particular period of time in its history, while removing evidence of other periods.

Reconstruction: Re-creates vanished or non-surviving portions of a property for interpretive purposes.

Historic Resource Inventory and Assessment: An inventory and assessment of University resources that meet the criteria for potential eligibility to be listed on the National Register of Historic Places. The inventory categorizes buildings into four designation levels depending on several contributing factors, and also contains a separate list of outdoor spaces and site features that are historic features in their own right.

Heritage Conservation Guidelines: Guidelines that address practices for renovation and alteration, operation and maintenance, or demolition of heritage buildings.



02

EXISTING CONDITIONS AND OBSERVATIONS

Introduction
Landscape
Edge Conditions
Stormwater
Buildings
Infrastructure
Mobility
Housing
Dining
Signage



INTRODUCTION

The master planning process started with campus observation, data gathering, and an in-depth analysis of existing conditions.

Since the 2004 Campus Master Plan, there has been rapid growth and development at Texas A&M University. In response to new campus conditions as well as the expanded scope of the 2017 Campus Master Plan to include the Health Science Center, Research Park and Hensel Park, many of the physical planning concepts from the 2004 Campus Master Plan have been re-imagined to accommodate the progress over the past thirteen years. This chapter introduces the existing conditions and campus observations that will be addressed by physical planning changes in later chapters.

Campus Context

Texas A&M University is located in College Station, Texas, (Brazos County) in East-Central Texas. College Station is proximate to the center of the region known as the Texas Triangle, located approximately 100 miles northwest of Houston, 100 miles east of Austin and 180 miles south of Dallas. The city is a traditional college town with more than 100,000 residents. Together, College Station and the City of Bryan make up the Bryan-College Station metropolitan area, popularly known as "Aggieland".

Texas A&M University is the flagship institution of the Texas A&M University System and is a land, sea, and space grant institution. Campus enrollment is over 66,000 students - which, by population, makes Texas A&M University the largest university in Texas and the third-largest university in the United States. Texas A&M is one of six American public universities with a full-time, volunteer Corps of Cadets who study alongside civilian undergraduate

students. The campus is also home to the George H. W. Bush Presidential Library. Texas A&M University is recognized by the Princeton Review as one of America's best colleges, and U.S. News & World Report lists the university among the top 75 public universities in the nation.

By physical size, Texas A&M's **main campus** is one of the largest in the United States, spanning more than 5,500 acres. It takes about 45 minutes to walk the three miles from Texas Avenue to Harvey Mitchell Parkway. The campus is physically divided by Wellborn Road and the Union Pacific Railroad Tracks (UPRR) which creates connectivity issues between the east and west areas of the campus. Academic programs are expanding beyond the central core of the campus, with the College of Veterinary Medicine and Biomedical Sciences and the College of Agriculture and Life Sciences north of University Drive, and the Health Science Center.



The existing conditions of the campus present challenges and opportunities to improve upon stormwater management, energy infrastructure, campus mobility and on-campus dining.



State of Texas Context

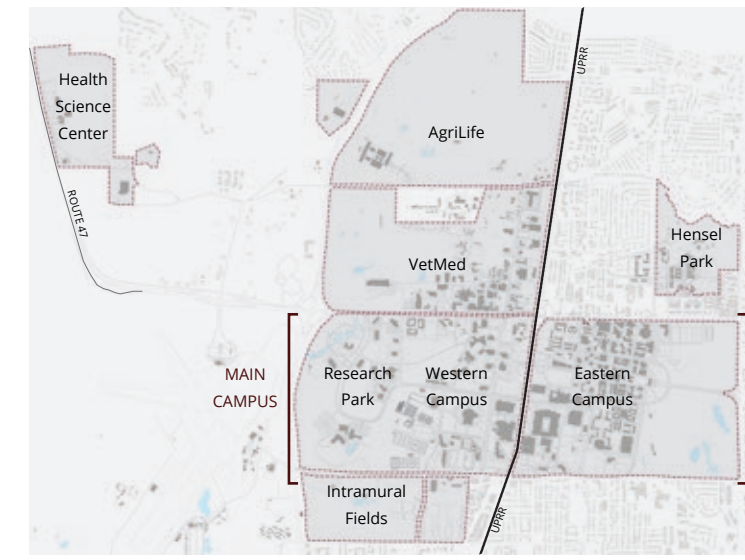

2017 Campus Master Plan Planning Boundaries

Campus Evolution

The Agricultural and Mechanical College of Texas opened in 1876 as the first public institution of higher learning in Texas dedicated to the study of agriculture, mechanical arts and natural sciences. The campus was established on a treeless prairie four miles south of Bryan.

Between 1876 and 1908, ten significant structures were designed by prominent Texas architects Jacob Larmour and Eugene Heiner. Structures of this period were characterized by picturesque massing, of the Second Empire style. The first building, Old Main, was sited on the high point of the campus defining the dividing line between the Brazos and Navasota River basins. The early **civic structure** formed by the first buildings would become the genesis of the campus spaces now known as Simpson Drill Field, Old Main Drive and the Academic Plaza. In 1884, the railroad depot was built west of the campus along what is now known as Wellborn Road.

Beginning in 1908 with the appointment of the first Campus Architect, F.E. Giesecke, formation of a majority of the historic core of campus took shape. Between 1908 and 1919 many structures that the campus considers Level 1 - Heritage Buildings were constructed, including the Academic Building (built to replace Old Main after it was destroyed in a fire), Nagle Hall, Bolton Hall, YMCA Building, Leggett Hall, Sbisas Mess Hall, and Francis Hall. These Classical Revival structures would define the campus style over the next two decades. The civic structure continued to form during this time with the development of Cushing, Academic Plazas, and Military Walk and what is known today as the campus street system.

In the 1930's, the campus began to change direction in architectural style, specifically with the construction of the Chemistry Building in 1929 designed by Samuel C. P. Vosper. This new character of the Historic Core of campus included animal figure relief, tile and stone mosaics and intricate ironwork. During this era Giesecke and Vosper collaborated on Scoates Hall, Animal Industries, Halbouty, the J.K. Williams Administration Building, and other structures. With the guidance of F.W. Hensel, the University's first Landscape Architect, the civic structure continued to form with the development of

an East Quad defined by Scoates Hall, Animal Industries and J.K. Williams Administration Building. Construction of new dormitories defined a new civic structure for the north and south sides of campus.

During the 1930's, Route 6 (known now as Texas Avenue) was established along the eastern edge of campus. A new axis was formed from the J.K. Williams Administration Building to the new highway. This new axis resulted in a major change in the campus planning of Texas A&M; the main entry of the campus was no longer considered along at Wellborn Road and Old Main Drive. The new entry from Texas Avenue to the J.K. Williams Administration Building was ceremonial and grand in scale.

Between 1942 and 1962, there was a period of rapid growth at the University. As a result of this rapid growth, many of the buildings do not relate architecturally to those built in the prior 70 years. Mainly the facades of the buildings are less ornate and do not represent the same character of the previous buildings. During this period, many of the buildings were being designed by outside firms, rather than the Campus Architect. Notable buildings from this time period are Memorial Student Center, Coke Building, Doherty Building, Henderson Building, and All Faiths Chapel.

Many of the campus planning decisions made in the 1960-1970's did not align with the civic structure that had been establishing over the past 100 years. The building growth on the west of campus during this period contributed to the decentralization of the campus. These buildings were typically program driven resulting in large, odd-shaped footprints and did not create corresponding green or open spaces on and around their site. The western campus buildings were far from the eastern campus buildings, and there was no uninterrupted physical link to cross Wellborn Road and the Railroad.

The campus has continued to grow from the original historic core. Even with the large amount of physical land mass available to the University, the fact remains that land is a finite resource and must be planned to both increase density and maintain a network of open space.

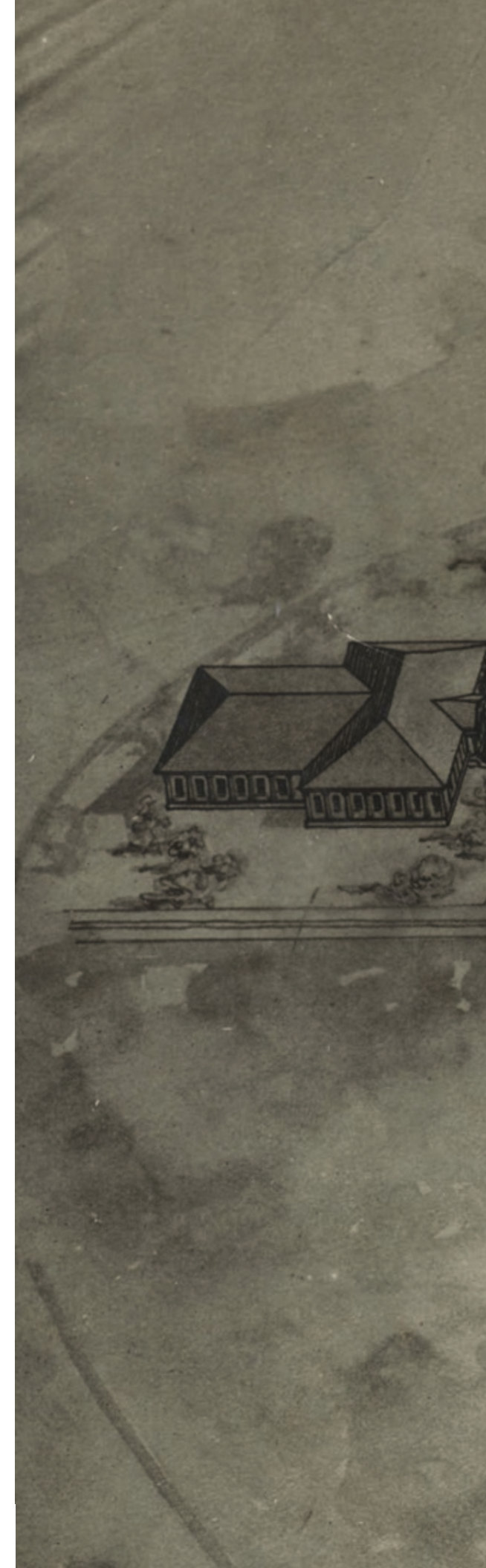

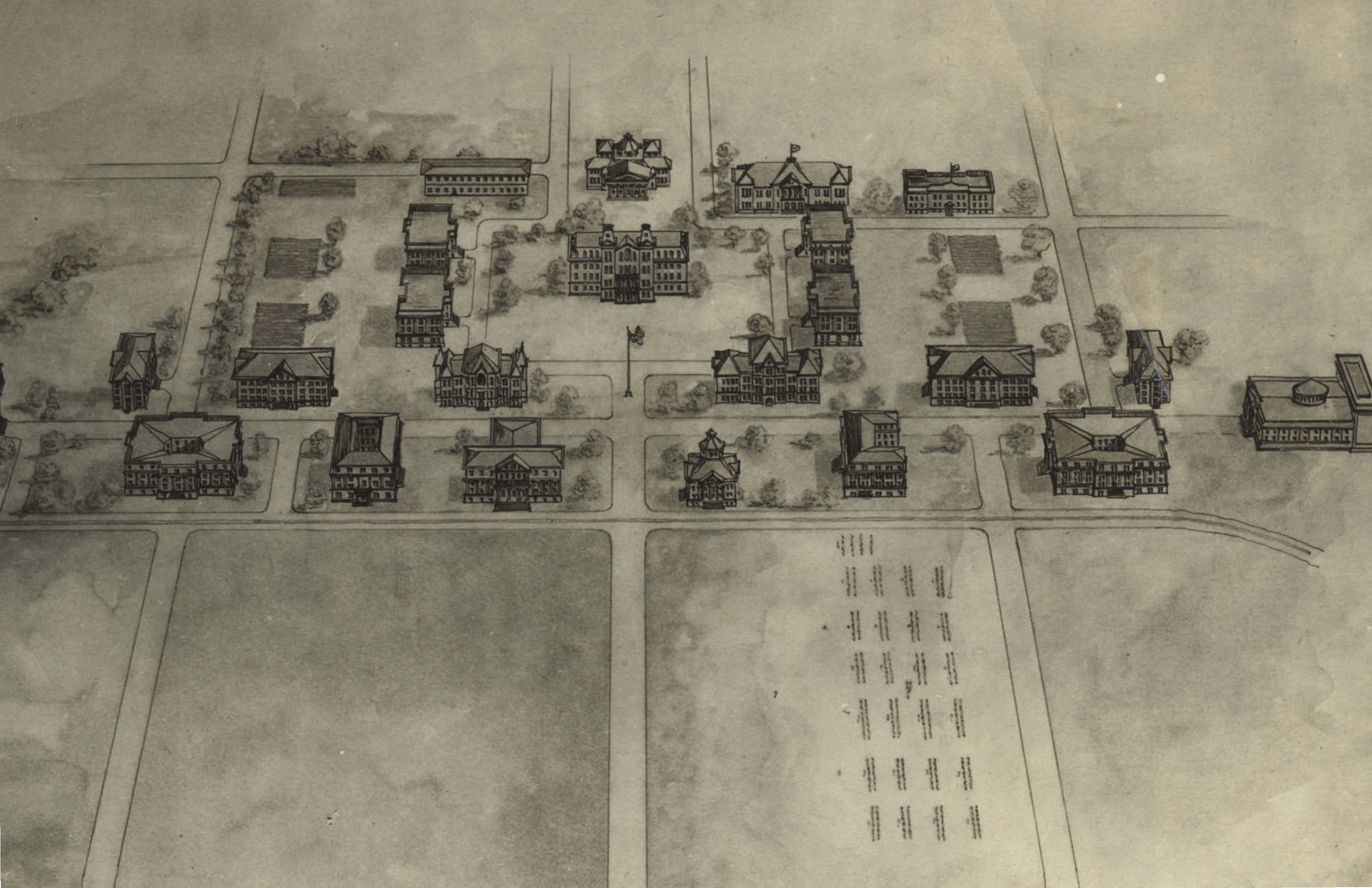

The Campus Today

The campus has begun to address the issues of decentralization through the connection to and development the western campus. The physical connection between the east and west areas of campus has been addressed through the construction of two grade separations along Wellborn Road and the Union Pacific Railroad Tracks. These connections have been successful in creating a stronger physical and psychological link between the two sides of campus. However, even with the addition of physical and visual connections, the low density, lack of usable green space, and the lack of services and amenities for students, faculty, and staff on the western portion of campus creates a feeling that this area of campus is still "over there". In order to truly unite eastern and western Campus, the density, ground plane and services must be equal on both sides of the UPRR. The vision for the west side of campus is to become an academic, research and housing hub, just as the eastern campus has been.

While the eastern campus is what many other areas of the campus strive be in terms of density, landscape and amenities, the eastern campus is not free from challenges or opportunities. Over time, utilitarian or service spaces have appeared within the east areas of campus, which take away from its historic civic structure. There are many interior surface parking lots that force personal vehicles into the densest and most populated areas of campus, creating conflicts between vehicles and pedestrians. Landscape and exterior spaces are overly paved, and do not contain the soft landscaping needed to create special, intimate spaces. Many of the most historic spaces in the east areas of campus are long overdue for restoration and rehabilitation.

Research Park was designed as a traditional 1990's suburban corporate park, with isolated buildings and surface parking scattered along a large curvilinear boulevard. As the campus development opportunities become more entrepreneurial, there is an opportunity to create a dense innovation district with partners that align with academic and research initiatives.

Areas north of University Drive/Raymond Stotzer Parkway, primarily occupied by the College of Veterinary Medicine Biomedical Sciences and Agriculture and Life Sciences, consist largely of open areas of pasture or farm land used for teaching and research. As the campus continues to develop, these areas should be preserved as teaching and research land.

The Health Science Center (HSC) is part of the Texas A&M University College Station Campus. The HSC has its own Campus Master Plan that will remain the guiding document for its physical built environment.



◀ Campus Aerial looking over West Campus

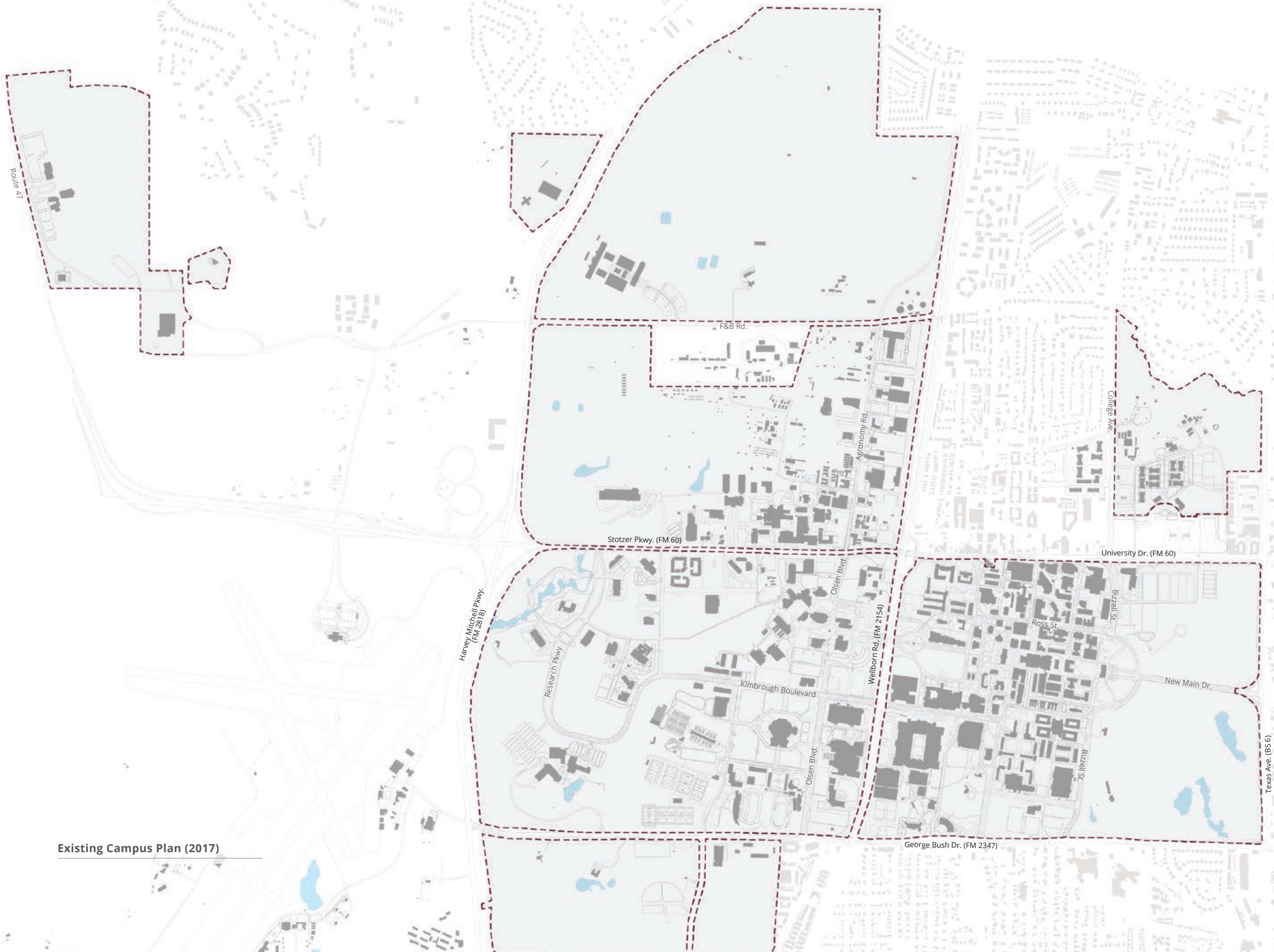

Existing Campus Plan (2017)

LANDSCAPE

Campus Landscape

The campus has a diversity of landscape types and materials. The specifics of materials, maintenance and upkeep, and design elements identify some areas of the campus as more significant or intentional than others. To create a network of cohesive and high-quality outdoor spaces, the site and landscape should read consistently. Major issues of the existing landscaping are:

Lack of diversity in trees and vegetation: The vegetation on campus is dominated by Live Oaks, Asian Jasmine and Bermuda grass. In the past, the mono culture of Live Oaks created a pleasant tree-lined and shaded walking environment through most of the eastern campus. However, over time these trees have begun to decline in health due to disease, construction impacts, and poor growing conditions. Oak Wilt, which is a fungus that travels from plant to plant through the root system and insects, is threatening the Live Oak population on campus. Specific maintenance techniques and trenching between trees can help against the spread of oak wilt.

Challenges with soils: The existing soils on campus consist of shallow top soils underlain by dense clay, which is common in Brazos County. The majority of the campus falls within the Post Oak Savannah ecoregion, which tends to have fairly unproductive soil types. These soils, coupled with saline irrigation water make growing conditions difficult. Soil amendment is critical in order to cultivate plants that are not native or adapted.

Too many materials used throughout campus: Landscape materials vary greatly from zone to zone on campus, based on occupants, time periods and project type. In the Historic Core alone, there are close to a dozen different hardscaping techniques used. Historically, large slick exposed aggregate was used as hardscaping in quads, malls and plazas. However, this material creates an unsafe walking surface when wet. More recent projects in the Historic Core, such as Liberal Arts and the Arts & Humanities Building, feature ornate paving patterns that tie to the building in a unique color palate that in

addition to its courtyard area wraps the historic East Quad.

Lack of Resources: The premier spaces on campus require high levels of maintenance and resources to maintain the highly manicured look desired by the campus community. Notable premier spaces include, but are not limited to, J.K. Williams East Lawn, Academic Plaza and Cushing Quad.

Large Areas of vacant or underutilized green space: Currently, the campus has many vast areas that are covered in turf grass and do not contribute to the landscape of the University. About 8% of the entire campus is vacant green space, located mostly in the western campus and Research Park. These areas have considerably high levels of maintenance due to the amount of mowing upkeep required. As the campus develops, these spaces will be replaced with buildings and new green spaces that contribute to the open space network.

Land Use: Nearly 40% of the campus is comprised of unassigned open space and parking lots. These areas are prime locations to build upon, creating new open space reinforced by new buildings. As the campus develops, the amount of unassigned open space and surface parking will transform significantly into character-enhancing spaces such as quads, malls, courtyards, educational space, etc. Open space reserved for educational use, such as the teaching areas north of Raymond Stotzer Parkway comprise 19% of campus land. These areas will not be considered for future development as they tie directly into the academic and research needs of the University.



Large open green space at Research Park



Unhealthy Live Oaks along Houston Street



Diversity of hardscape within Academic Plaza





Specific Areas for Improvement



Evans Library Malls: On the north and south side of Evans Mall there are large areas of exposed aggregate concrete that are abruptly broken up by angular planters with lawn and sporadic tree plantings. The existing grading prevents clean circulation through the space due to the flat areas interrupted with steep climbs on slippery paving. Image: Library Mall Evans



Northside Housing: The housing precinct on the north side of campus does not have the adequate outdoor amenities that are required for today's college experience. The spaces between and adjacent to the residence halls are underutilized and do not have a consistent design or intention. A large central parking lot takes up valuable open space that could be used for recreation and outdoor program.



Cushing Quadrangle: Cushing Quad is an example of an older space on campus that is overly formal in character and was not designed to be actively used. The quad is excessively hardscaped which results in little space to congregate. In addition, the pedestrian paths do not align with or support the larger pedestrian network.



University Drive: University Drive has the potential for a strong town-gown relationship, but it currently lacks a defined edge. This weakens the physical connection into the community. The pedestrian paths along University are undersized and in need repair. Traffic movement along University Drive also tends to be fast, hindering pedestrian movement across the drive.



Simpson Drill Field: The high use that civic landscapes receive poses significant challenges to plant longevity and the iconic appearance of these spaces. Simpson Drill Field is currently used for civic programs such as the Corps of Cadets Final Review, for large campus events such as concerts, and for daily recreation use. This central open space lacks adequate drainage. The field has highly compacted and tight soils and lacks sufficient grading to accommodate surface run off. This causes the turf to become damaged, making maintenance and repair daunting tasks.



West Campus "Quad": This is a large, vast, open space between several scattered buildings. The paving to softscape ratio is adequate for a Quad space, however, the paving pattern is too informal and circuitous. The curvilinear pathways do not provide clear direction, space definition, hierarchy of pathways, or define smaller spaces desired for gathering.



Lamar Street and Nagle Street: These limited access streets located near the center of the Historic Core offer intuitive pedestrian connections into the academic core of campus, but are currently used for parking.



Hensel Park: Hensel Park is located at the intersection of Texas A&M campus, the City of College Station and the City of Bryan. The park is underutilized and worn, but its location offers an opportunity for a campus-community connection. Currently the connections into and out of the park are weak and programmed spaces are poorly defined.

EDGE CONDITIONS

Edges mark the line along which two regions are related and joined together. Strong campus edges acknowledge the pedestrian scale and experience, creating thresholds that reinforce the identity of both the campus and the surrounding communities.

Healthy edge conditions promote a relationship to the surrounding community (also known as town-gown relationships) and can lead to improved branding and identity, local economic growth, better relationships with community partners, safety for university members traveling to campus, and recruitment of world class students and faculty who desire features and amenities that can exist surrounding campus. Poor edge conditions can lead to hazardous conflicts for pedestrians and vehicles moving on and off campus, economic disinvestment adjacent to campus, and ambiguity in identity.

Depending on the adjacent programs, an edge might be more or less permeable. Overall, there is low permeability across a majority of the Texas A&M edges. Defined by larger block sizes and surrounded by major roadways, much of the campus edge lacks cross-walk or grade separated connections to allow easy movement on and off campus. Surface parking lots and driveways also line much of the campus side edge, making for an inhospitable frontage. This frontage also has little to no brand identity in areas, lacks a defined and uniform landscape, contains long stretches without shade, and has large building setbacks. Each of these elements is detrimental to the edge relationship and creates a disassociation between campus and community.

One of the more successful edges to campus is the stretch of University Drive between Boyett Street and College Avenue. On the south side of University (campus side) there is a density of activity stemming from the northside housing and various academic programs that sit adjacent to the roadway. On the north side of University Drive (community side), active uses such as restaurants and stores provide a destination for the University community

and local residents alike. Good spacing of crosswalks keep the pedestrian block size manageable and facilitate movement on and off campus. Opportunities still exist to improve this stretch. Presently, the landscaping poorly defines Texas A&M's presence, and driveways and parking lots on both sides of the street still present pockets of unsafe vehicular obstacles for pedestrians.

Edges can also be internal. Wellborn Road and the Union Pacific Railroad tracks create a strong edge between eastern and western campus physically and psychologically dividing them in two with a largely impermeable barrier.

Opportunities exist to enhance streetscaping, improve branding, create new pedestrian linkages for improved safety, and infill on parking lots to enhance the campus edge. Collectively, these improvements will help create a more defined and active town-gown relationship and facilitate the movement of people to and from campus.



Wide roads and long stretches without pedestrian crossings







Internal Edges

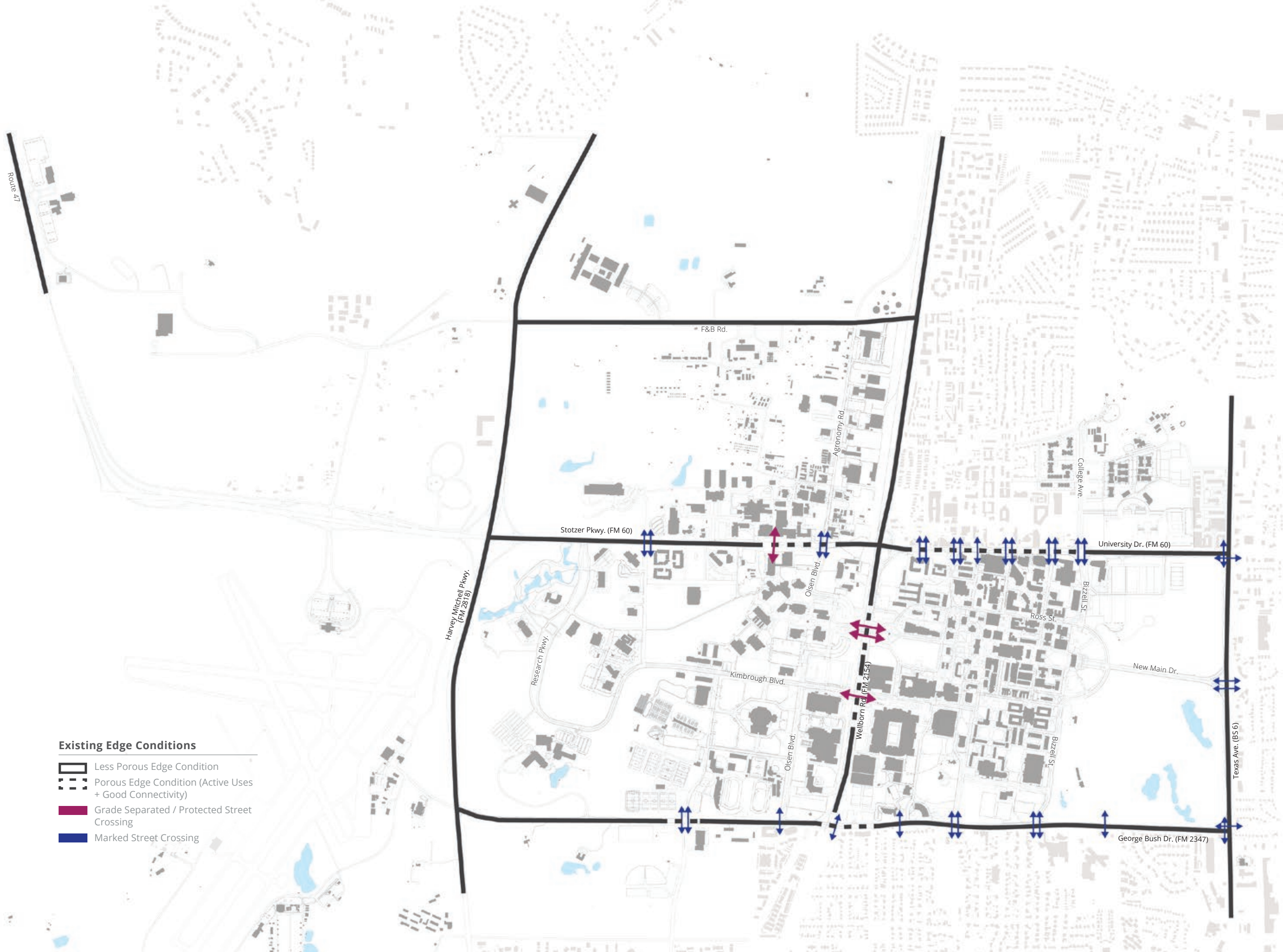

External Edges



Existing Edge Conditions

-  Less Porous Edge Condition
-  Porous Edge Condition (Active Uses + Good Connectivity)
-  Grade Separated / Protected Street Crossing
-  Marked Street Crossing

STORMWATER



The University landscape has relatively little topographic change and includes incised stream channels that present surface water features on campus.

The campus straddles two watershed areas and primarily drains southwest through White Creek and Turkey Creek into the Brazos River Watershed. The remainder of campus drains southeast through Bee Creek and Wolf Pen Creek to the Navasota River Watershed. Texas A&M has interlocal agreements with the City of College Station regarding stormwater management.

Stormwater runoff is the excess quantity of water on a land surface that cannot be infiltrated into the soil where it falls following a storm event. This water travels on the ground surface and in subsurface water channels into downstream water bodies, creating erosion and transiting pollution. Impervious surfaces such as building footprints, roadways, and parking lots block precipitation from soaking naturally into the ground and exacerbate quantity and quality issues in stormwater runoff. Soil type also impacts the ability of the ground to absorb water. Texas A&M's predominantly clay soils have little capacity to retain water and become inundated from relatively modest storm events. The 95th percentile storm at Texas A&M is a 1" storm and even this volume of water has difficulty infiltrating into College Station's soils.

Because of the fast pace of campus development and the difficulty of funding infrastructure, it has been challenging for Texas A&M's stormwater management system to keep pace with development. With the addition of new buildings and large surface lots, particularly in the western portion of campus, the runoff into White Creek has been exceptionally high and has caused rapid erosion of the creek. During storm events, the campus has major drainage issues – buildings flood, pedestrian paths pool water, and open spaces become swamps in post-storm conditions. Most of the courtyards and quadrangles on campus have been designed to divert stormwater off-site into the storm sewer system as quickly as possible, limiting infiltration and groundwater recharge,

and flooding underground systems with a high volume of stormwater.

Currently, there are few low-impact development solutions for stormwater on campus, which in turn causes large volumes of water to run directly into storm drains and eventually out to the creek. To address known stormwater issues, the University has recently approved a project to construct several new detention ponds along White Creek, and is moving forward with new detention ponds along Harvey Mitchell Parkway and on the Golf Course.

A campus-wide stormwater management plan that embraces landscape infrastructure in addition to improved piping infrastructure has been developed to support the stormwater management process for future construction projects.

This information is located in Chapter Five, Sustainability and Wellness, and articulates strategies compatible with low-impact development.



Erosion at White Creek



Erosion at White Creek



Drainage Issues

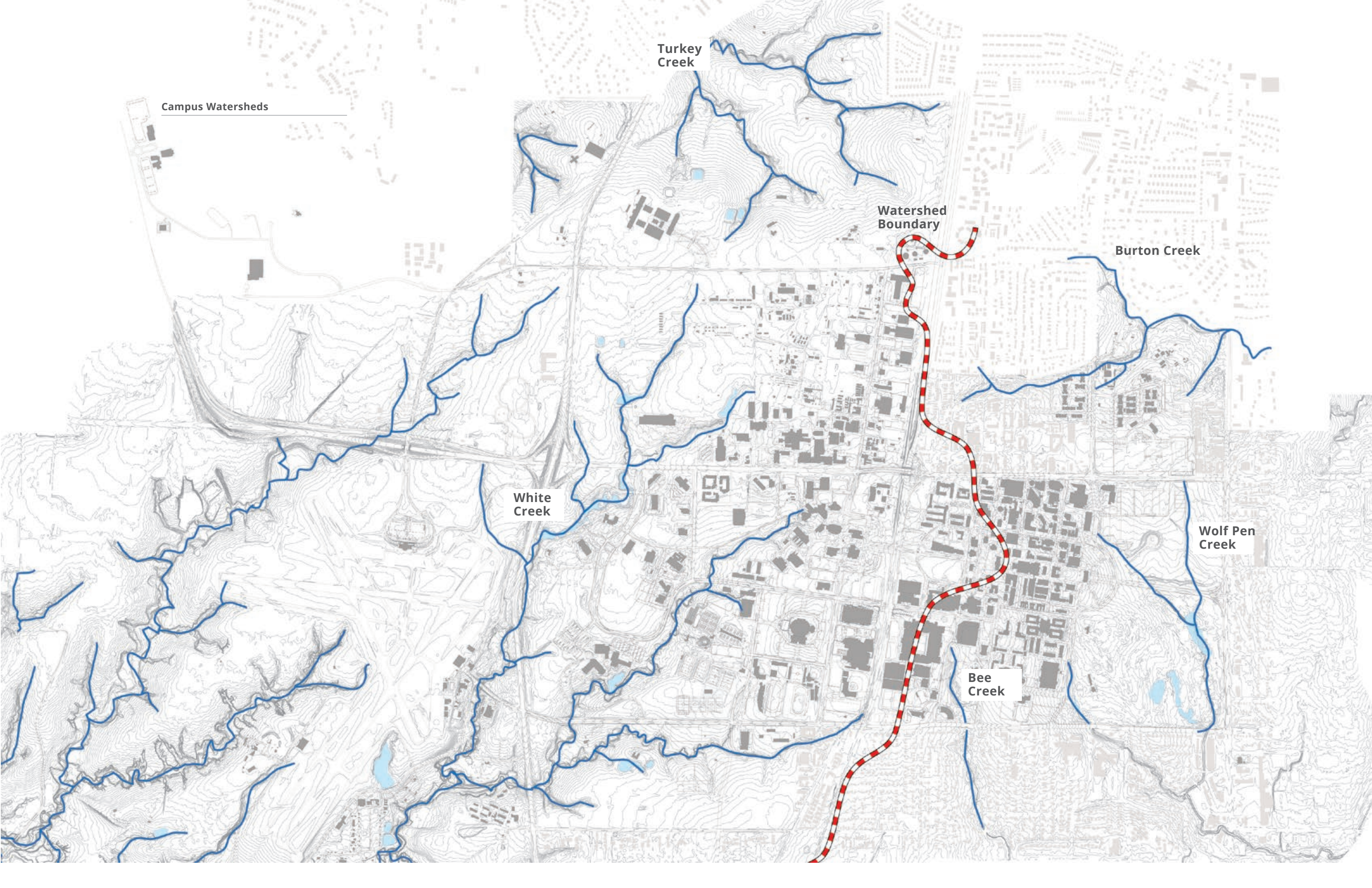

Campus Watersheds

Turkey Creek

Watershed Boundary

Burton Creek

White Creek

Wolf Pen Creek

Bee Creek

BUILDINGS

Building Use

At over 18 million gross square feet* of space, the existing building inventory is a robust collection of varying architecture styles, program types, and building uses. The eastern campus has many typical American campus features, such as a dense core of academic programs, an administrative building, student center and library centered within; housing surrounds this core. The density and organization of the east part of campus is typical by campus standards.

Dissimilar from eastern campus is the low density development that occurred west of Wellborn Road and the railroad starting the 1960's. This growth resulted in two disjointed academic centers on either side of Wellborn Road. The density and organization of the west portion of campus is not characteristic of a typical campus and creates a disparity between the two sides of Wellborn Road. This physical separation and distance is exacerbated by differences in architectural style and landscape treatment. Recently, a new housing precinct was built adjacent to the western campus academic core. However, not all core campus functions have spread west to support these residents, causing a fragmented experience for many campus users. The limited dining options in this area are symptomatic of the lack of amenities, and compels residents to travel across Wellborn Road or off-campus for greater dining opportunities.

Athletics and Recreation is concentrated into a large zone along the south edge of campus. Numerous recreation fields and large athletics venues, such as Reed Area and Kyle Field, create a distinct and identifiable presence along George Bush Drive. The Campus Recreation Center is located to the west of Wellborn Road, but is well connected to eastern campus through the Pickard Underpass. Recreation Fields are located on the west end of the Athletics/Rec Zone. Existing recreational fields east of Penberthy are currently planned to be relocated in the near term to just south of George Bush Drive.

Research functions are concentrated within Research Park, but as development occurs, academic and service functions will likely integrate within this zone, increasing diversity of space use.

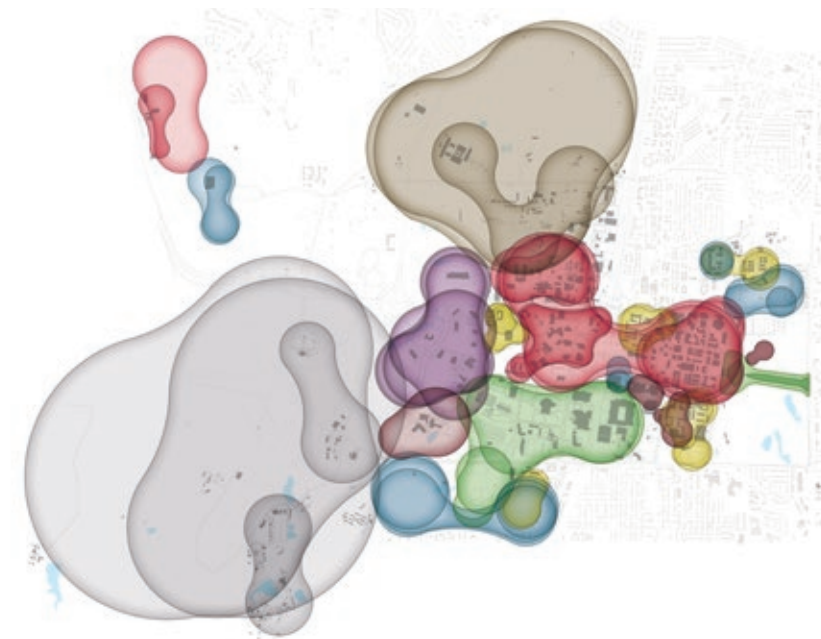

Building Uses (Amoebas)

- Academics
- Housing
- Athletics/Recreation
- Research
- Bush School/Library
- Agriculture
- Partnerships
- Airport

Program Amoebas

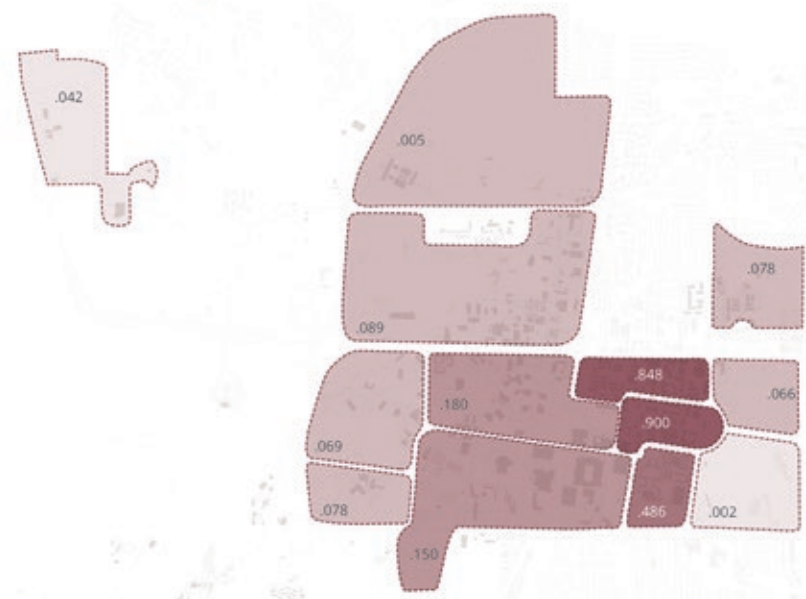

Existing Density (Floor Area Ratio)

- 1.00+
- 0.50 - 0.99
- 0.25 - 0.49
- 0.10 - 0.24
- 0.05 - 0.09
- 0.00 - 0.049

Existing Floor Area Ratio per zone (measure of Density)

* Planning team has identified approximately 18.7M GSF within the 2017 Campus Master Plan planning boundary, Campus Inventory indicates 20M+ GSF

Building Uses

- Academic
- Housing
- Student Support
- Laboratory
- Library
- Athletics and Recreation
- Facilities
- Administrative/Special Function
- Parking Structure

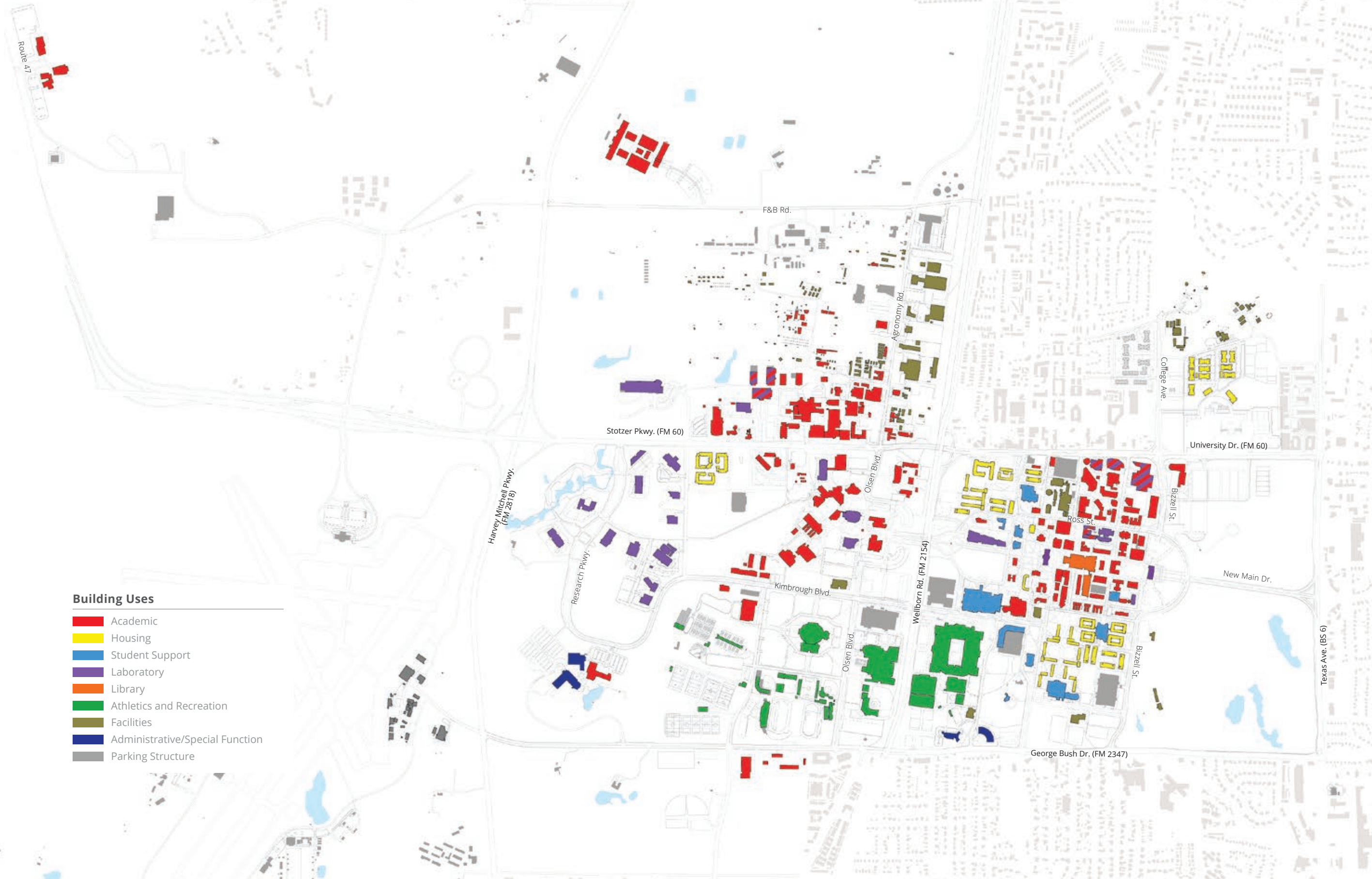

Building Conditions

Building ages at Texas A&M University range from one year old to over one-hundred years old. 24 percent of buildings on campus are more than 50 years old, and 55 percent are more than 25 years old. Despite the long history of the campus, many of the buildings have been well preserved and renovated over time. Thus, close to 75% of the building stock is satisfactory.

The **Facilities Conditions Index (FCI)** compares the cost to modernize a buildings primary systems against the cost to replace it with a new building. The University has identified four FCI levels:

Satisfactory: Facility is suitable for continued use with normal maintenance.

Remodel A: Facility requires restoration to acceptable standards without major room changes, alterations, or modernizations. The approximate cost of Remodeling A is less than 25 percent of the estimated replacement cost of the building.

Remodel B: Facility requires major physical updating and/or modernization. The approximate cost of Remodeling B is greater than 25 percent and less than 50 percent of the estimated replacement cost of the building.

Remodel C: Facility requires major remodeling. The approximate cost of Remodeling C is greater than 50 percent of the estimated replacement cost of the building.

A high FCI does not necessarily mean that the building will be demolished. The Academic Building has a high FCI, but it is an iconic building built in 1914. There are also buildings that do not add to the heritage of the campus that have a poor FCI, and demolition is most likely the best decision for these structures. In Chapter Seven, Conservation and Heritage, the Demolition Process is outlined.

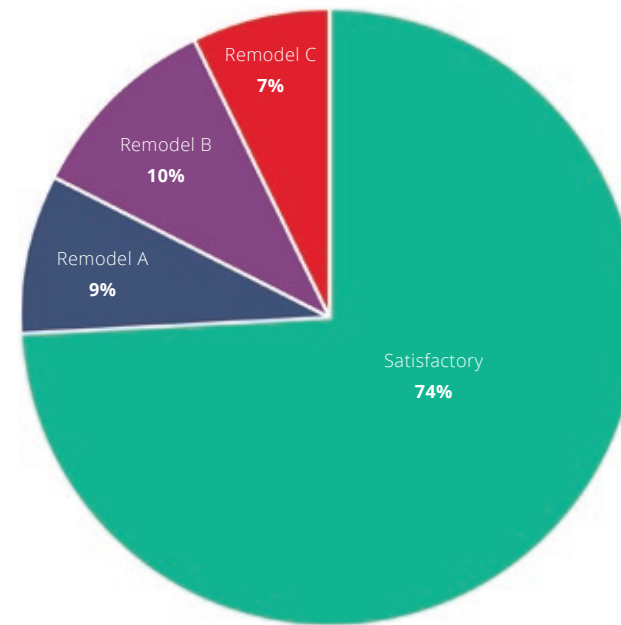



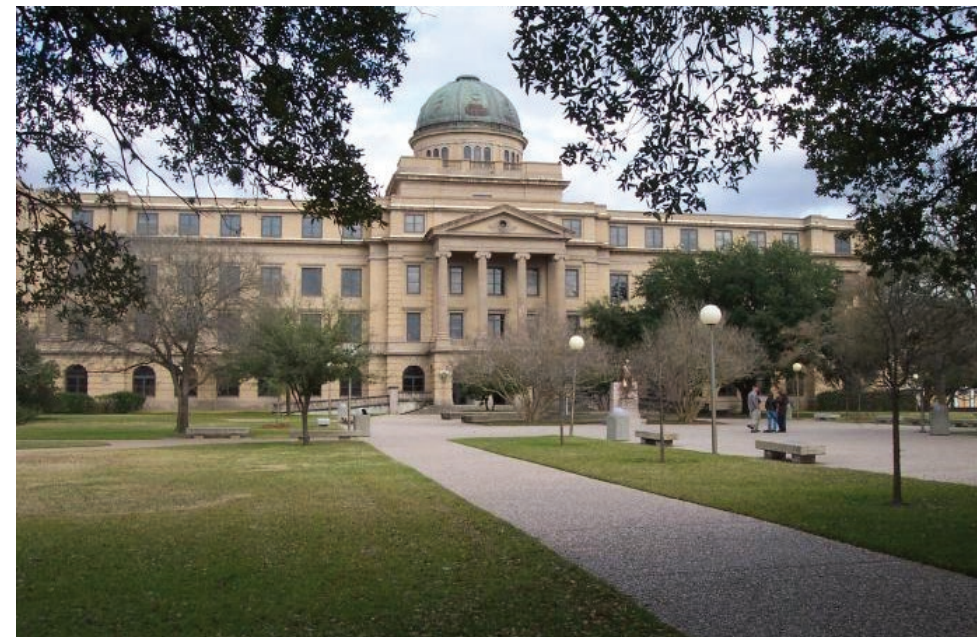

Texas A&M University Building Inventory: Facilities Conditions Index



The Academic Building is identified as a Remodel C, which indicates that the building will need major remodeling.

Facilities Conditions Index

-  Satisfactory
-  Remodel A
-  Remodel B
-  Remodel C

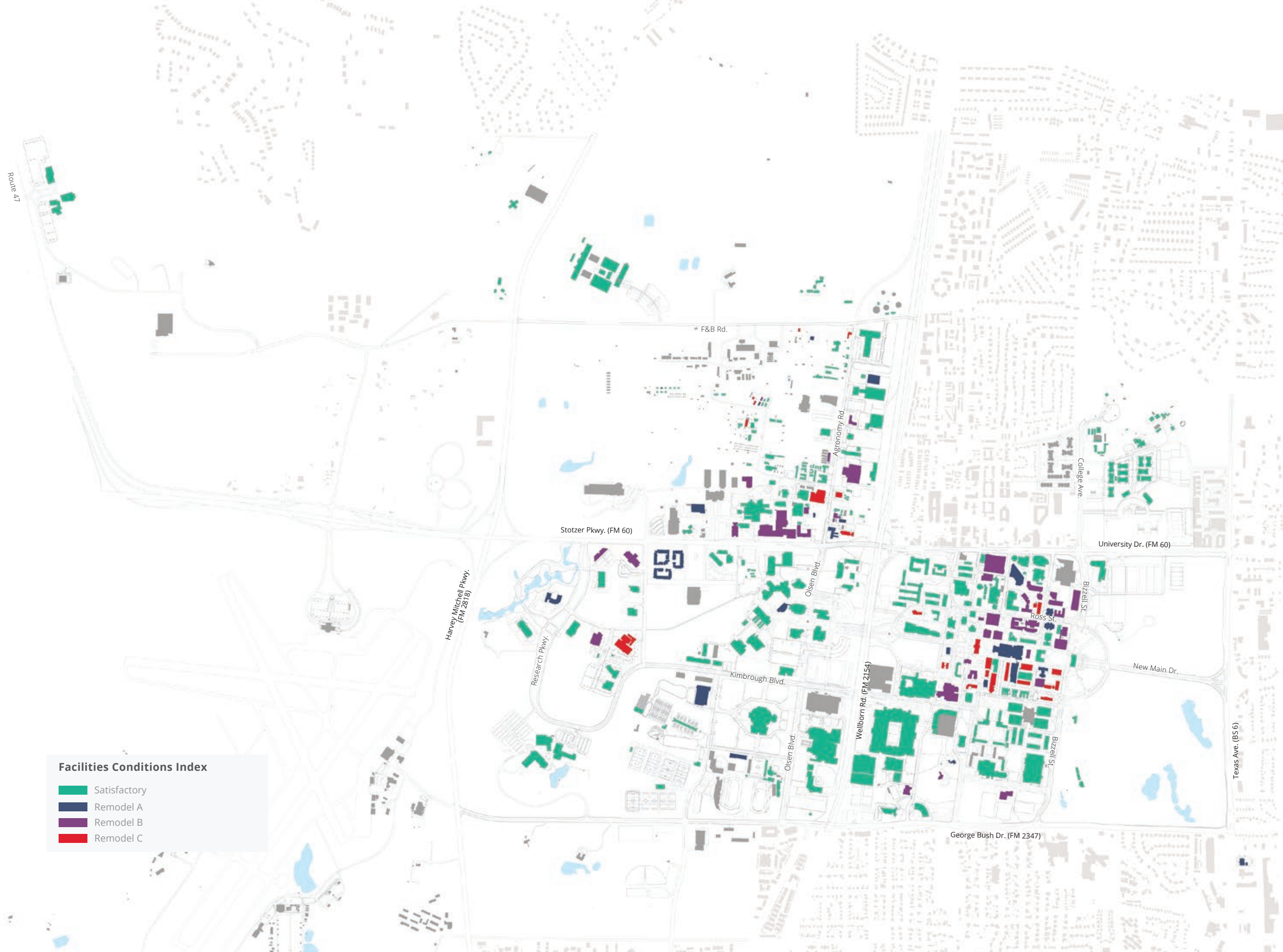



Texas A&M University operates a sophisticated campus utility system which provides the campus with electricity, heating, cooling, domestic hot water, and process steam of over 24 million GSF from four utility plants. The Central Utility Plant, or CUP, is the only plant that generates all five of these utilities. It is the main source of campus electricity (serving approximately 70% of the campus electrical load) and the only plant that produces steam for campus distribution.

Texas A&M has been recognized for the reliability and efficiency of its utility systems. In 2013, the Combined Heat and Power (CHP) system associated with the CUP received an Energy Star® CHP award from the US Environmental Protection Agency. The campus also received a Climate Award from the International District Energy Association for “campus-sized” systems in 2013.

Each of the five utility services are briefly described below.

Electricity

The CHP facility operated at the CUP was upgraded in 2011. Since then it has been capable of providing 50 megawatts (MW) of electrical power to campus. A single Gas Turbine Generator (GTG) produces 34.5MWs, while two Steam Turbine Generators (STGs) produce another 16MWs (11MW installed in 2011 and 5 MW installed in the mid-1950s and recently completely overhauled). The campus annual peak load is approximately 70MW. Load not met via onsite generation is serviced by redundant 138kV transmission feeds from the Electric Reliability Council of Texas (ERCOT).

Electricity is distributed to campus buildings via feeder loops in concrete encased ductbanks. The main distribution points – West Campus Switching Station, Heldenfels Switching Station, and the Research Park Switching Station – service the feeder loops.

Steam

Steam is produced in the CUP from a variety of assets including a heat recovery steam generator – using waste heat from the GTG and duct firing – and conventional gas fired boilers. The steam production assets are relatively new having all been installed since 2007. The assets in place provide for N+1 redundancy.

Steam is primarily used for internal plant processes, to generate electricity via STGs, to produce chilled water via large steam driven centrifugal chillers, and to produce heating hot water via steam-to-hot water heat exchangers.

Steam is currently distributed to only 6 campus buildings that require steam for process uses.

Chilled Water

Texas A&M operates a very large campus chilled water system. Each of the four utility plants produces chilled water. The Central Utility Plant produces chilled water with both electric centrifugal and steam centrifugal machines. Satellite Plants 1, 2, and 3 all produce chilled water using electric centrifugal machines. Installed capacity between the four plants is approximately 65,000 tons.

The chillers have been installed at different times throughout the last four decades. As such, there is a range of refrigerants used including CFC-11, HCFC-123, HFC-134a. The steam driven centrifugal chillers in the CUP are the oldest chillers in operation on campus and are past their recommended service life. The 2012 Utilities Master Plan recommended replacement of each of these units and calls for replacing one unit with an electric centrifugal machine in lieu of in-kind replacement with a steam centrifugal.

A Thermal Energy Storage tank was added to the campus chilled water system in 2015. The 2.4 Million gallon tank was constructed on the west side of SUP2 and is used to shift peak electricity use associated with chilled water production to off-peak hours.

Heating Hot Water

The heating hot water system provides heating to nearly all campus buildings and is generated in all of the utility plants. At the CUP, shell and tube heat exchangers take steam from the heat recovery steam generator of the CHP plant and convert it into hot water for campus distribution. The west campus hot water load is met by natural gas boilers in Satellite Plants 1, 2, and 3. These boilers have all been installed since 2004 and are 84-87% efficient. A Heating Hot Water facility in a new utility plant (SUP 4) is currently being planned to expand capacity for future growth in the west areas of campus

The heating hot water system is generally operated at 140 degrees F. Portions of the system have been operated as low as 130 degrees F but building comfort control problems have been observed at temperatures below this.

Domestic Hot Water

Domestic hot water is centrally generated in the CUP and Satellite Plant 3. Domestic hot water is only distributed to buildings on eastern campus. Buildings on the west of campus have unitary hot water heaters for domestic purposes.



The purple lines illustrated above indicate where the paths of chilled water and heating hot water are coincident. The yellow areas highlight utility corridors where chilled water, heating hot water, and electrical service are coincident. Impinging on these corridors would require significant financial investments to move utility lines.



The maroon lines illustrated above indicate the paths of electrical service on campus. The yellow areas highlight utility corridors where chilled water, heating hot water, and electrical service are coincident. Impinging on these corridors would require significant financial investments to move utility lines.

MOBILITY



One of the greatest challenges to the efficient functioning of Texas A&M is moving around its large campus. What may be considered the primary academic campus, stretching from Bizzell Street west to Penberthy Road, covers over one square mile, and many university facilities lie well outside that zone. Circulation challenges extend far beyond the campus boundaries due to the many thousands of people traveling to and from campus daily, and to high-attendance events, such as football games.

In addition to foot travel, the Texas A&M community relies on a combination of transit, biking, and private vehicles to move about campus. These modes are supported by a robust transit system with an annual ridership of over seven million, parking facilities encompassing 37,000 spaces, and an established and growing bike path network.

Existing Pedestrian Network

Despite the campus' great size, all areas are served by an extensive network of pedestrian paths. Key linkages, such as the pedestrian underpasses at Wellborn Road and Raymond Stotzer Parkway and pedestrian malls located in the east areas of campus, help to provide connections between zones on campus. The pedestrian experience of campus, however, is burdened by lack of shade and shelter in many areas, poorly aligned pathways and planters, long travel distances - both physically and perceptually - and conflicts with bicycles and motorized vehicles in many locations.

The East Texas climate is hot and humid most of the year. Shaded walkways are important to maintain pedestrian comfort. The size of the core campus alone pushes the limits of what can be covered on foot during class change time, and travel between eastern and western campus requires several additional minutes. This distance is created by the wide right-of-way for Wellborn Road and the Union Pacific Railroad Tracks. While travel between the two areas is facilitated by pedestrian underpasses across Wellborn Road, the long vistas and lack of shade make the trip burdensome.

The density of foot, bicycle, and vehicular traffic creates congestion and conflict in many campus areas. The most significant of these are along Bizzell Street between Ross Street and University Drive, the intersection of Spence Street and Lamar Street, and the numerous pedestrian gateways to campus along University Drive and Bush Drive. The core campus specifically experiences tension between pedestrians, bicyclists, and skateboarders. This is compounded by the haphazard placement of planters and grassy areas within quads and pedestrian corridors which impede straight paths of travel and the weaving of foot and bike traffic.

Existing Grade Separations

A Grade Separation, such as an underpass or bridge, is a means to avoid disrupting the traffic flow on intersecting routes of travel. The 2004 Campus Master Plan recommended grade separations north and south of Old Main Drive, to supplement the existing Pickard Pass separation at Joe Routt and John Kimbrough Boulevards.

Pickard Pass lies intuitively within the pedestrian network. It is highly utilized, especially by the many students who park in the West Campus Garage and Lot 100. Clearer bicycle markings and signage are needed to limit conflicts between bicycles and pedestrians. Also, some cyclists descending the pathway east of the garage find it difficult to moderate their speed and negotiate the right-hand turn into the underpass, risking spills or collisions.

The grade separation at Old Main tends to be less utilized. It is, however, heavily used during class change time by pedestrians traveling between the West Campus Quad and the Memorial Student Center.

A pedestrian tunnel passing under Raymond Stotzer Parkway connects Reynolds Medical Sciences Building to the Veterinary Hospital. It is an interior corridor, unaccessible to cyclists, and not well-known to most students.







Interaction between mobility systems



Unshaded and shaded walkways on campus provide for different pedestrian experiences

Pedestrian Circulation

-  Pedestrian - Vehicle Conflict Hotspots
-  Primary Pedestrian Routes
-  Pedestrian Paths
-  5 & 10 Minute Walk Radius
-  Grade Separations

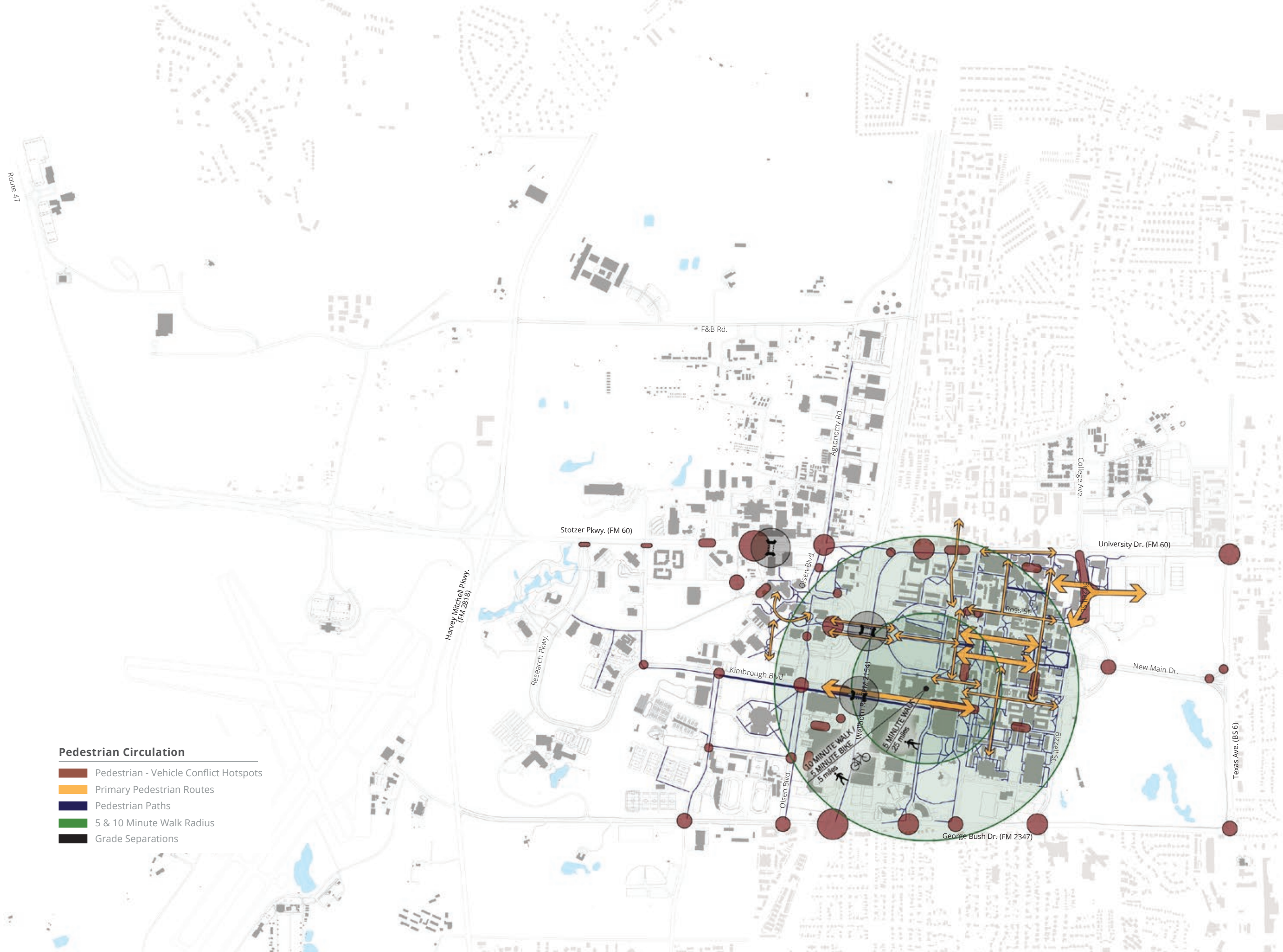

Existing Bicycle Network

The student body at Texas A&M University is an active, bike-using community. Bike-users and other vehicles tend to have the same primary routes to the campus. The bike users interact not only with cars and buses, but with pedestrians as well. Pedestrian paths tend to over-flow with bike-users as they cut between buildings, leading to conflicts and safety concerns. There is a need to separate pedestrians and bike-users in order to minimize their interactions, and increase safety of both modes.

Bicycle parking is well distributed due to demand. The academic core is filled with many parking locations. However, at some buildings there are more bikes parked than there are spaces. Existing conditions indicate that abandoned bicycles are a real challenge for maintenance staff and it is unclear how much of the bicycle parking overflow could be addressed simply by better bicycle culture.

As bike-users leave the campus, the network pathways at intersections with peripheral roadways or city paths do not provide sufficient capacity or safety for riders. Poor connectivity between campus and city bicycle path networks forces cyclists to cross busy intersections and roads, resulting in a number of bicycle-vehicle collisions each year. Existing road conditions tend to leave bike-users unsure of where they are supposed to be. For example, the intersections of University Drive and Bizzell St, Texas Avenue and New Main Drive, and Marion Pugh Drive and George Bush Drive have seen quite a few incidents involving bike-users. There is scope for increasing safety by improving existing roadways and intersections, as well as installing new signals where necessary.

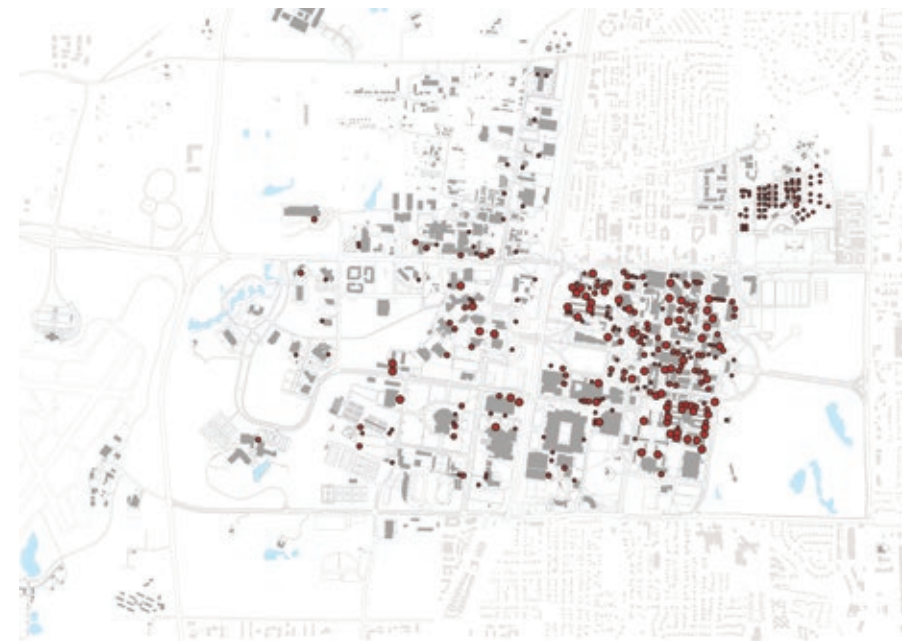

Existing Bike Parking Locations



Bicycle Parking on Campus

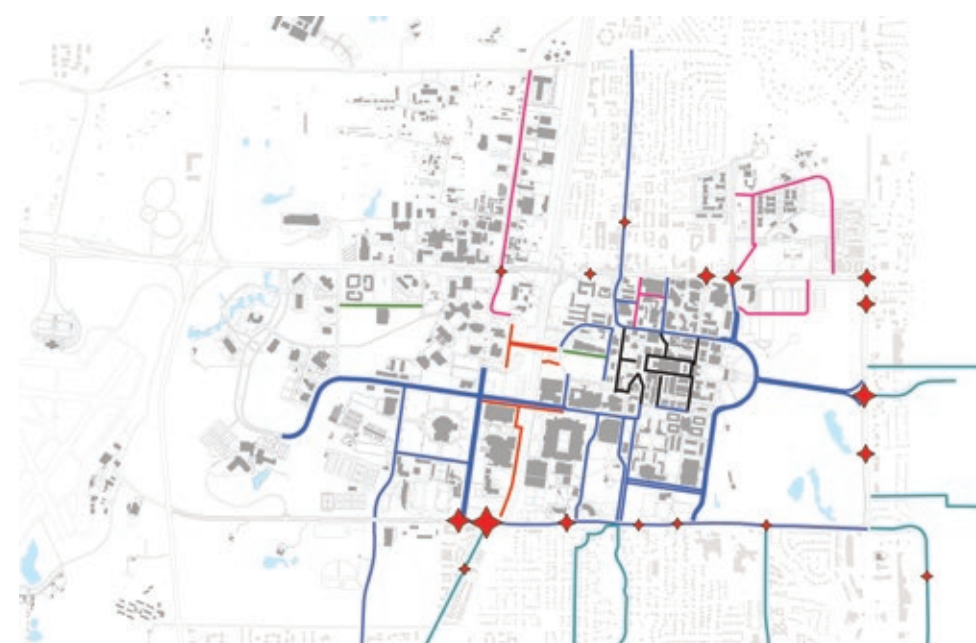







Existing Bike Network and Crash Locations, Size of star indicates frequency of incidents at each location



Conflict Areas at Bizzell Street and Olsen Boulevard

Existing Bicycle Network

-  Multi-use Path
-  Bicycle Lane
-  Sharrow (Bicycle Route)
-  Buffered Bicycle Lane
-  Sidewalk Routes
-  City of College Station Bicycle Routes

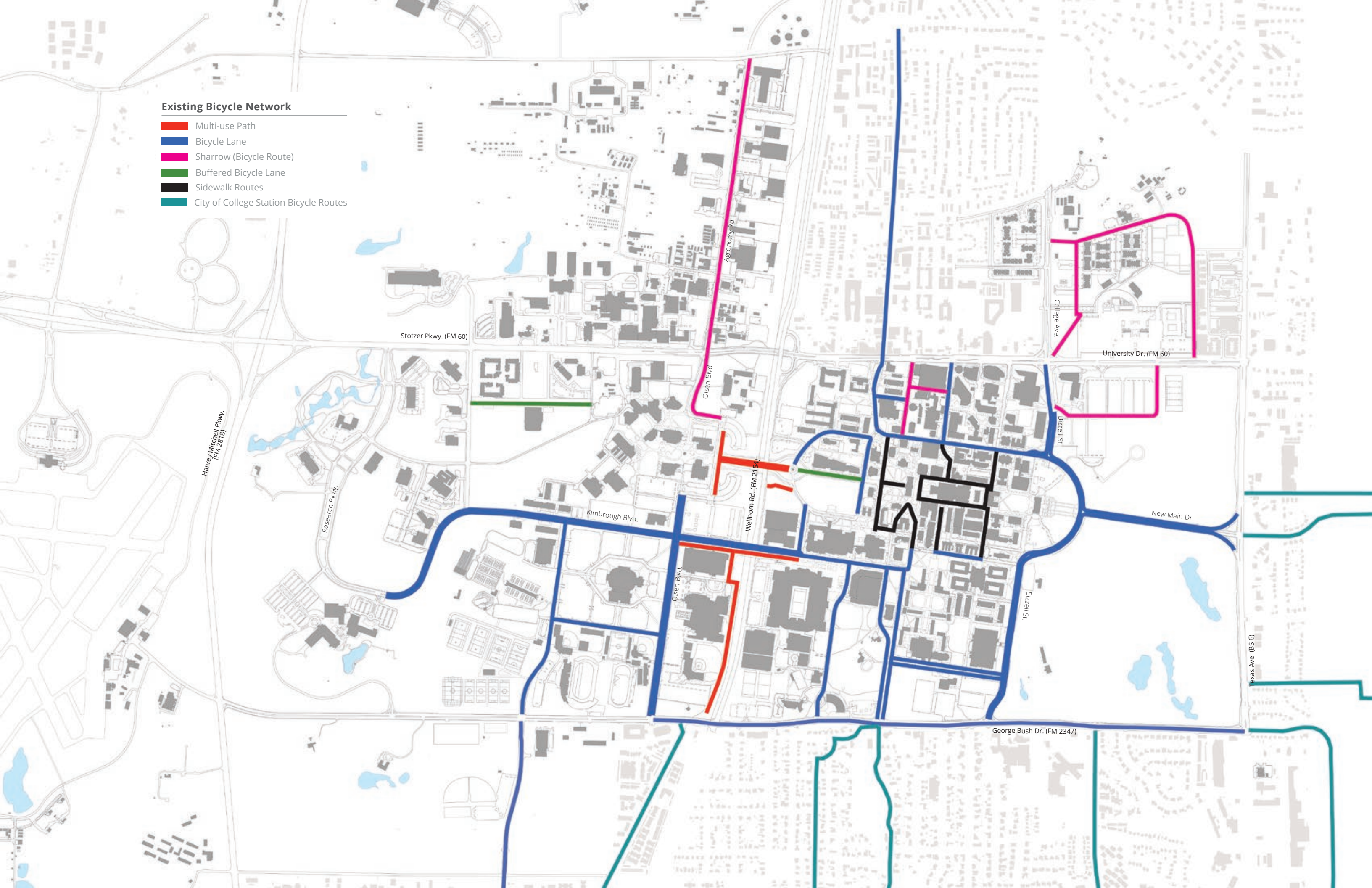

Existing Transit / Bus Network

Texas A&M University has a strong transit network with wide reaching coverage both on and off campus. Transportation Services currently operates a fleet of 80 buses providing on and off campus para-transit and charter services. The services cover a little over 1.75 million service miles each year. The existing transit system has eight on-campus routes and 10 off-campus routes which connect Bryan and College Station to campus.

Annual ridership is about 7.5 million trips. The routes run regularly, with higher frequency in the mornings and evenings for students to seamlessly commute to and from their classes. Despite its robust coverage, the system still has room for improvement. During peak hours, not all students are able to board the first bus to arrive at their stop. Once a bus is full, drivers do not stop again unless requested by a passenger on-board. This capacity challenge can be attributed to the growth in student population and subsequent growth in off-campus housing. Some areas off-campus will benefit from increased or modified bus routes to improve student circulation.

Brazos Transit District also has one transit route that reaches the University. This route circulates between the Memorial Student Center and City Transit Hub along Texas Avenue once per hour. The route connects students to the larger Bryan and College Station area, but depending on schedules and transfers, this commute could take up to 60-90 minutes. As off-campus development continues to grow, alignment of City routes with Texas A&M University routes should occur.

The transit hubs in front of the Memorial Student Center and the Trigon often have large numbers of students queuing to board the bus. These transit hubs lack adequate shelter facilities to provide shade and seating for waiting riders. Improvements to queuing areas along Houston Street and Coke Street should be incorporated into plans for these areas.



Transit Stop at the Trigon



Existing transit shelters on campus



Transit Stop at the Memorial Student Center

Existing Transit Network

- ◆ Time Point Stop (Scheduled)
- Waypoint Stop (Requested)

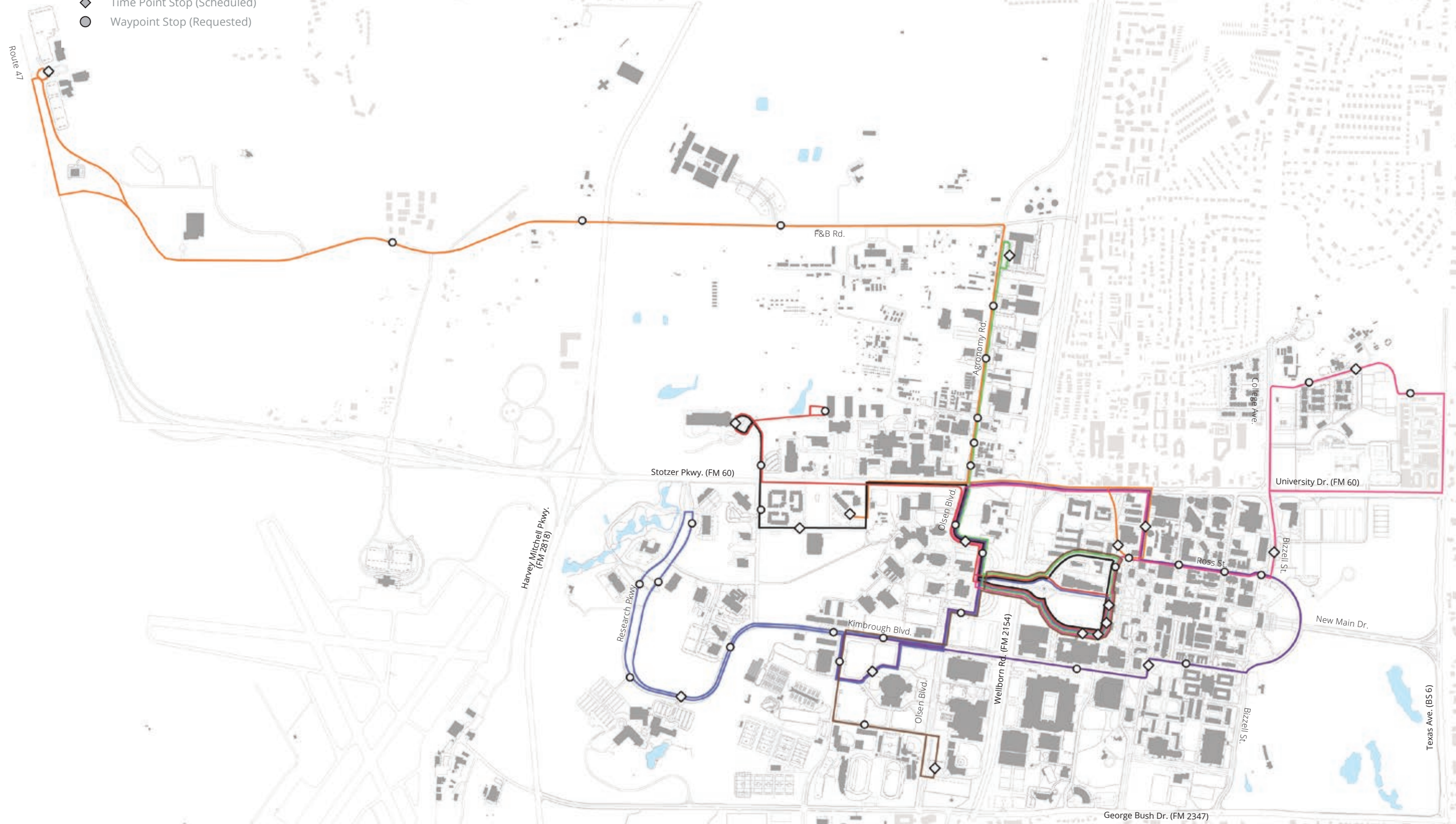

Existing Vehicle Network

The University is accessible from four major roadways adjoining the campus – University Drive/Raymond Stotzer Parkway, Texas Avenue, George Bush Drive and Wellborn Road. Common features of these roadways include multiple lanes, high speeds, and the interaction of multiple modes of transport. This mixing can create confusion for all of the modes. Hence, separation of the modes could improve the vehicular circulation in and around campus.

Within the campus core, roads are generally smaller, having a single lane of travel in each direction. Outside the core, roads are larger, and frequently have boulevard or parkway sections characterized by large medians and multiple lanes of travel. On some roads, most significantly on Research Parkway and Olsen Street, medians are large enough to constitute a loss of developable land. The Wellborn Road-Union Pacific Railroad corridor uniquely impacts campus, bisecting it and resulting in a functional disconnect between east and west areas of campus. Historically, the Wellborn Road-Union Pacific Railroad corridor has posed a significant safety obstacle to pedestrians.

The campus road network provides capacity to accommodate all vehicles that traverse the campus. However, it is important to account for the interaction of vehicles with pedestrians and bike-users during rush hours. Many campus users drive through campus to reach designated small parking lots behind specific buildings. This adds to undesired traffic within the pedestrian zone. Pedestrian activity causes stop-and-go situations for drivers, which is further exacerbated by students crossing at non-designated locations.

As a result of the 2004 Campus Master Plan, the University has begun to restrict access to some roadways on the eastern campus. A combination of time-of-day, pass card, and transit-only limitations are used in these areas. This policy has improved the safety and character of the pedestrian experience, and has strong support from the campus community for its continuation and expansion. In addition to decreasing the presence of vehicles in pedestrian areas, road restrictions aid drivers by simplifying the number of routes available and promoting more predictable behavior.





Wide multi-lane roads with higher speeds line the edge of campus



Nagle Street currently provides limited vehicular access to Evans Library and the Historic Core

Existing Roadway Network

-  Unlimited Access Roadway
-  Limited Access Roadway

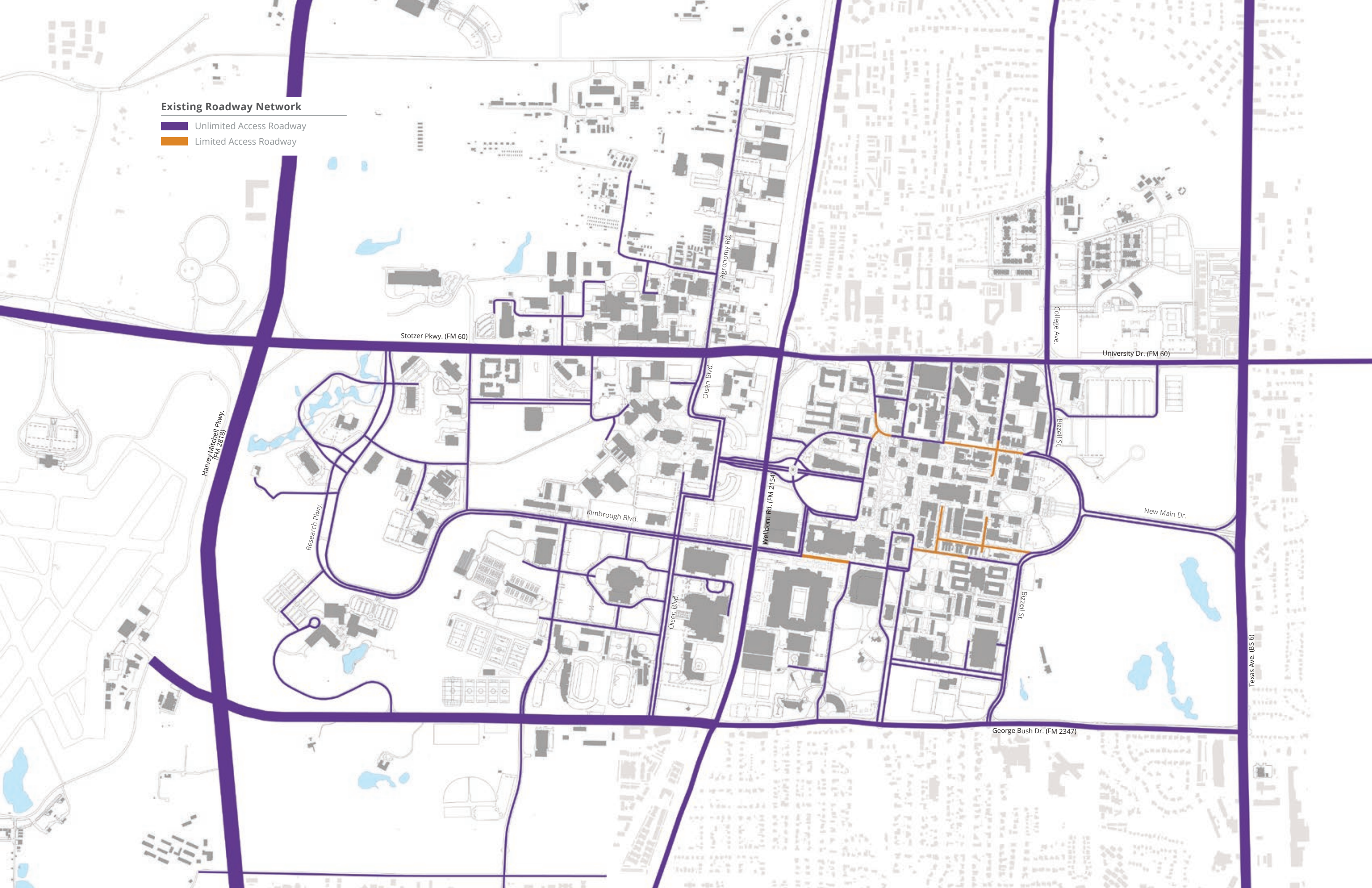

Existing Parking Network

Parking on the Texas A&M campus is provided by numerous surface lots and six parking garages. Currently, there are over 37,000 parking spaces on campus. The surface lots are widely dispersed through campus, ranging in size from small lots holding only few cars to very large ones each covering several acres. The total net coverage of surface lots exceeds 40 acres and houses 73 percent of the total parking spaces on campus. This area is roughly equal to that of the academic core, as demonstrated on the parking compilation diagram to the right. Of the 37,000 spaces on campus, 9,561 are located in garages.

The six garages offer reasonable coverage for most of the eastern campus, with only the far corners lying outside a five-minute walking radius from the center of the academic core. Most facilities on the west side of campus are well outside the West Campus Garage's five-minute walk radius. This is particularly true for White Creek Apartment residents. No structured parking currently exists north of Raymond Stotzer Parkway. As a result, travelers to these outlying campus areas face a mixture of long treks to their vehicles, exposure to the elements, and diminished enjoyment of the campus experience.

The current distribution of parking contributes to traffic congestion and pedestrian safety concerns. The dispersal of lots can lead to the opportunistic hunting for spaces by drivers - a behavior which is at odds with sustainability goals and pedestrian safety. Many students rely on the large outlying surface lots east of Bizzell Street and those around Reed Arena which are serviced by the campus transit system which helps facilitate the movement of students into academic areas. These isolated lots contribute to personal safety concerns for students, faculty, and staff after hours.

The quantity of paved surface, particularly in the western areas of campus contributes greatly to stormwater runoff and soil erosion. To address these

concerns, the University is increasingly relying upon stormwater detention basins to manage runoff, making these areas unavailable for other purposes. The 2004 Master Plan recommended that Texas A&M should start to strategically transform some of these surface lots into greenspace, building sites, or structured parking. This would enable the University to enhance the campus environment, reduce the negative effect of the vast quantity of impervious cover, and better utilize valuable land resources. This Master Plan effort builds upon these same principles.

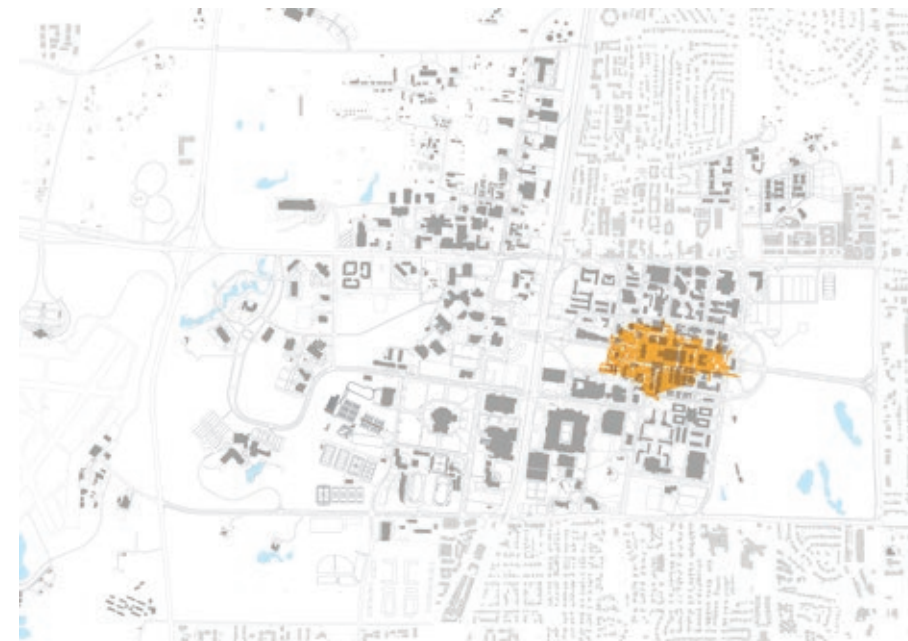

All Parking Compiled



Many large surface lots exist on campus



Parking lots occupy valuable real estate



Parking structures provide good coverage for East Campus

Existing Parking

- 5-Minute Walk Radius
- Surface Parking Lot
- Parking Structure

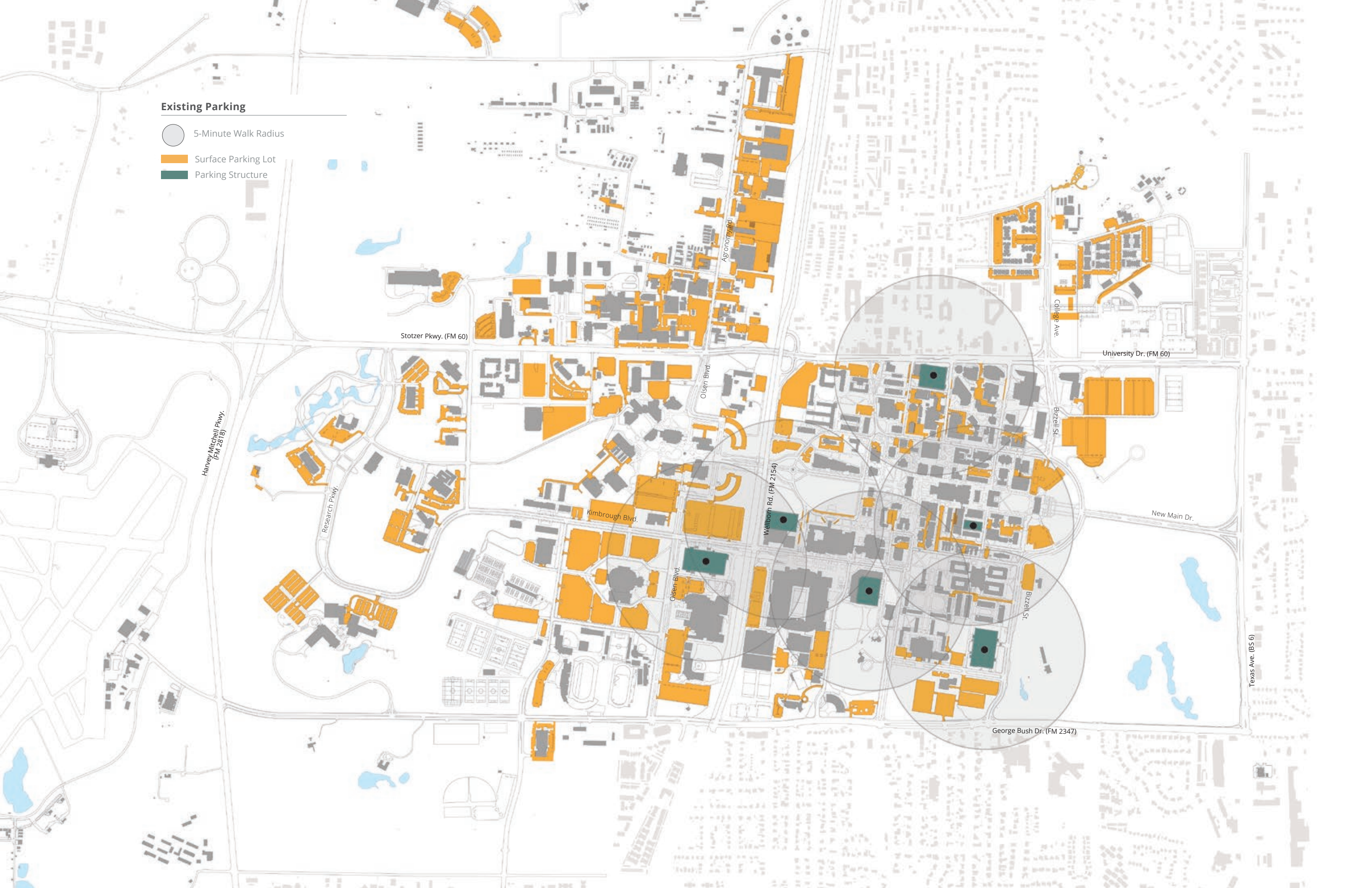

HOUSING

Residence Halls support the recruitment and retention of students as well as promote their academic success. The residential experience should act as a competitive amenity that contributes to the University's brand. When residence halls encourage community-building, students create stronger long-term ties with each other and the University.

Housing on Campus

Presently, Texas A&M University has an on-campus bed inventory of over 11,000 located within four separate campus geographic **precincts**: Northside, Southside, West Campus and The Gardens (located adjacent to Hensel Park). The Northside and Southside precincts, are located immediately adjacent to the academic core. This close proximity provides the students living in residence halls great access to the educational, dining, and recreational programs which define the traditional college experience.

Housing options in the West Campus and at The Gardens precincts are further removed from academic core. Students living in these units are currently isolated from dining services and, due to the distance from core amenities, these students may have less engagement with campus features, activities, and programs when compared to those living in residence halls located in the Northside and Southside precincts.

Choices of housing on campus include a mixture of traditional, semi-suite, and apartment style unit configurations. While many of the 11,000 existing beds are located in older structures, a majority of the complexes have been well maintained. Recent renovations have been made to many of these older resident halls enabling Texas A&M's housing inventory to meet the space, program, and amenity needs of students. In addition to the older halls, Texas A&M partnered with Balfour Beatty to complete phase 1 in 2015 of the White Creek Apartments located in West Campus. Future phases of the White Creek Development have been planned.



Residence Halls on campus reflect a diversity in age and unit style

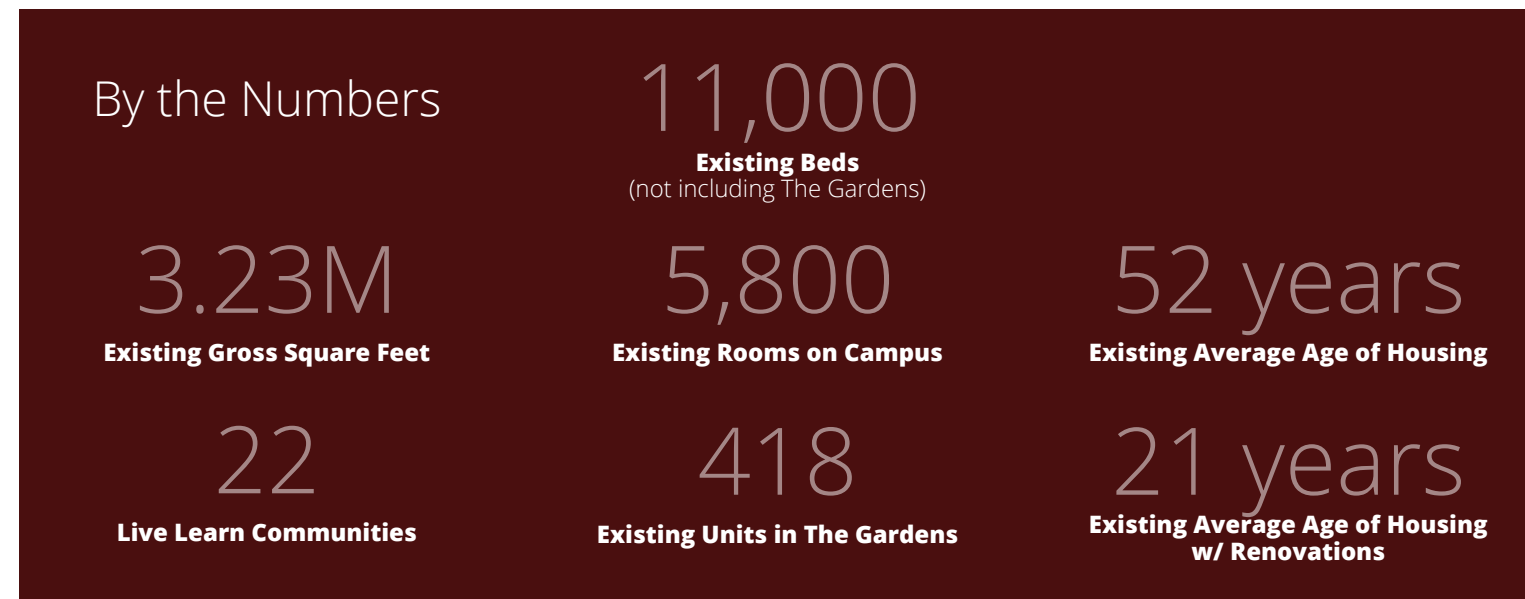

Route 47

F&B Rd.

Agronomy Rd.

Stotzer Pkwy. (FM 60)

College Ave.

The Gardens Housing Precinct

University Dr. (FM 60)

West Campus Housing Precinct

Northside Housing Precinct

Harvey Mitchell Pkwy. (FM 2818)

Olsen Blvd.

Bizzell St.

Research Pkwy.

Ross St.

Kimbrough Blvd.

New Main Dr.

Southside Housing Precinct

Wellborn Rd. (FM 2154)

Texas Ave. (BS 6)

Olsen Blvd.

George Bush Dr. (FM 2347)

Existing On-Campus Housing

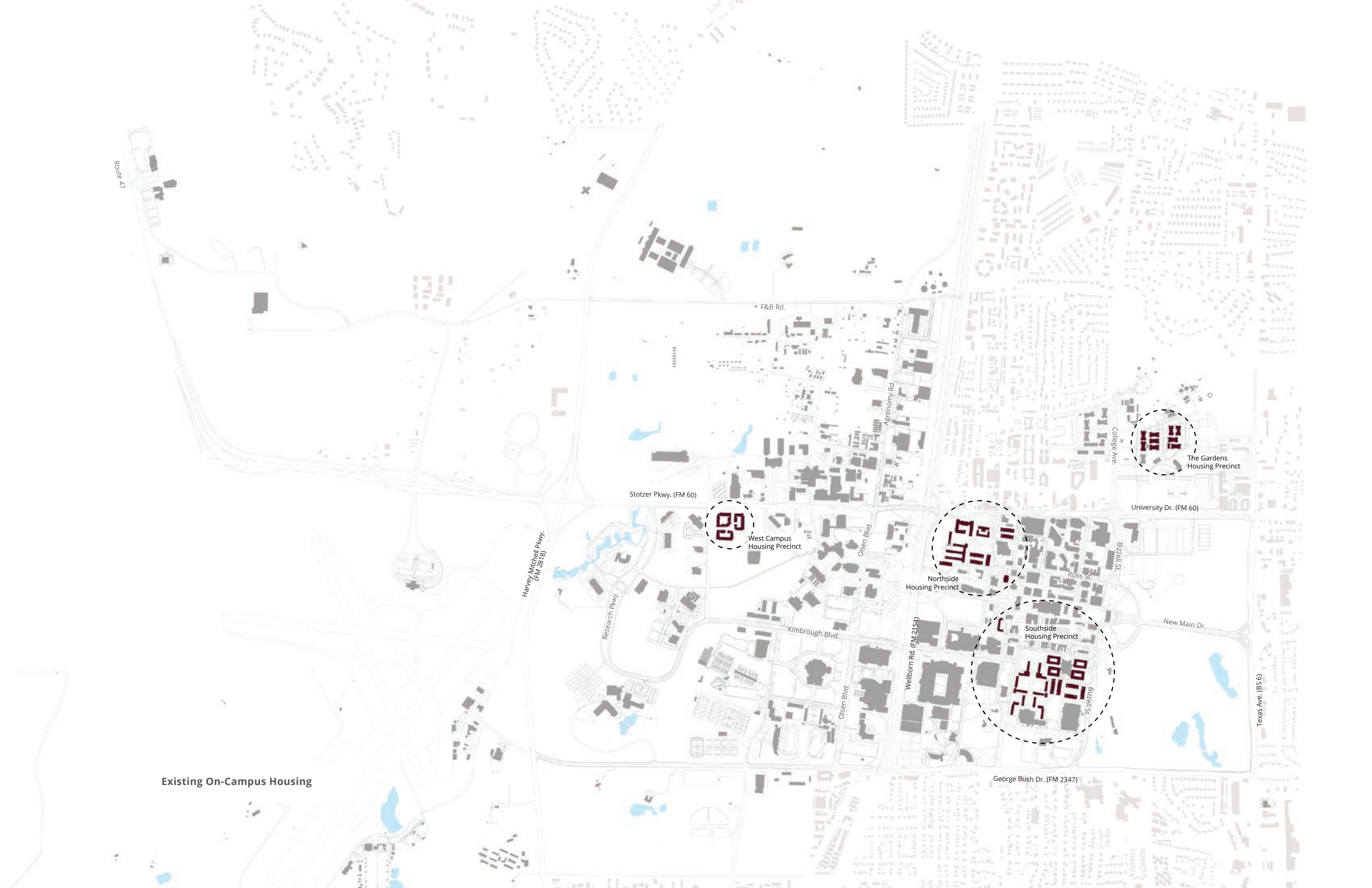

Housing Profile

Residence Life works to provide housing to meet the differing needs and preferences presented by the diverse student body. One key tenet is the acknowledgment of “age” preferences and the desire to provide options that meet the needs of all years within the student body.

In the Fall of 2016, more than 61 percent of the students living on campus were freshman. Sophomores made up another 18 percent of the residents. While there are members of every year scattered across the four housing precincts, a few clear patterns are visible.

- **Southside Housing:** Higher numbers of sophomore, junior, and senior residents attributed to Corps members being required to live on campus unless approved by the Commandant.
- **The Gardens:** Low number of freshman due the disconnect from traditional campus amenities and unit offerings more attractive to families.
- **Northside and West Campus:** Both closely reflect the campus wide housing student profile averages

Residence Life at Texas A&M works to accommodate the diverse needs of students by offering housing at a variety of price points, a feature not present at many universities. Through consideration for the variable preferences of the student body, Texas A&M is able to offer a wider range of housing choice that can be more directly tailored to the needs of its large student body.

Another unique feature Texas A&M offers incoming residents is the opportunity to join the Living Learning Programs (LLPs). LLPs are live learn communities which benefit from additional resources, support, and enhanced activity centered around specific focuses in order to elevate resident experience. Organized focuses range from shared academic discipline, shared academic interests, shared scholarship programs, shared social interests, and themed communities. LLPs provide a framework to immerse into a deeper educational experience by helping students to form supportive social networks and collaborate more frequently with peers.

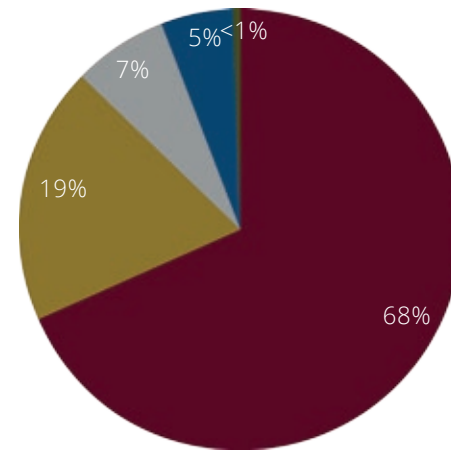

Population Distribution (2016):
Northside Housing

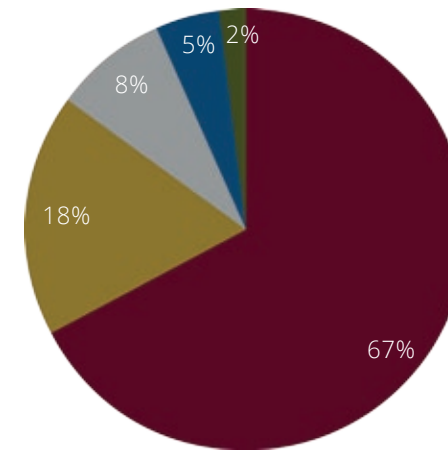

Population Distribution (2016):
West Campus Housing

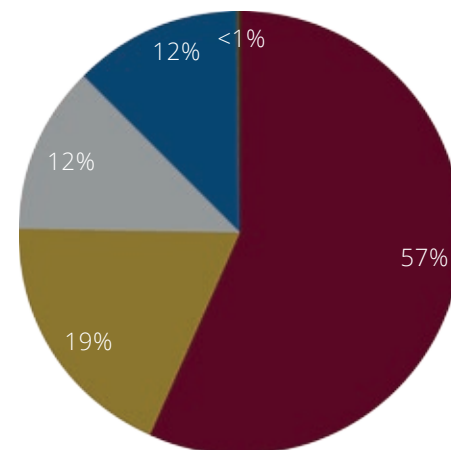

Population Distribution (2016):
Southside Housing

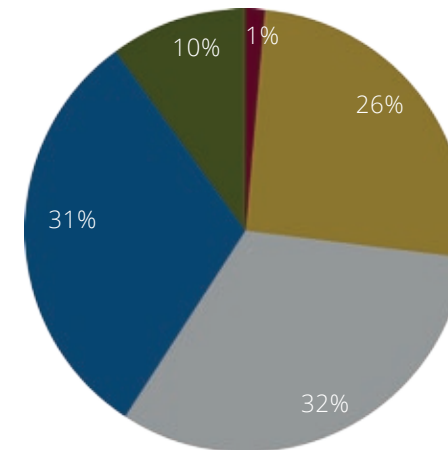

Population Distribution (2016):
The Gardens (Hensel Park) Housing

Distribution by Class

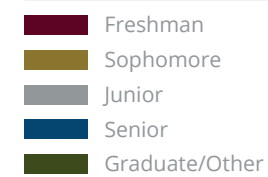

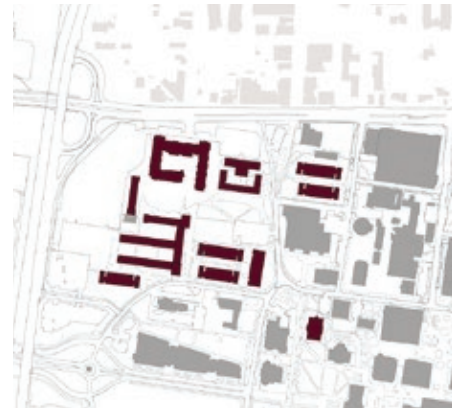

Existing Housing Profile: North Campus

Building Name	Existing Bed Count	Existing GSF
Clements	235	62,156
Davis-Gary	130	40,828
Fowler	250	57,696
Haas	270	69,668
Hobby	240	69,669
Hughes	90	38,957
Hullabaloo	640	254,040
Kelthley	245	57,696
Lechner	200	59,541
Legett	155	45,134
McFadden	235	62,156
Moses	205	40,828
Neeley	270	69,668
Schuhmacher	160	38,957
Walton	310	51,494



Existing Housing Profile: West Campus

Building Name	Existing Bed Count	Existing GSF
White Creek A	420	176,046
White Creek B	420	181,714
White Creek C	420	181,681

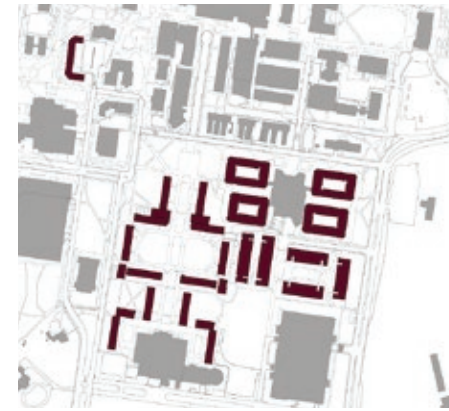

Existing Housing Profile: South Campus

Building Name	Existing Bed Count	Existing GSF
Appelt	300	82,767
Aston	460	113,388
Dunn	460	112,133
Epright	235	67,283
Hart	270	50,416
Krueger	460	112,133
Mosher	660	155,430
Rudder	235	67,283
Underwood	300	81,730
Wells	235	67,283
Corps Dorms	2,600	428,509



Existing Housing Profile: The Gardens

Building Name	Existing Bed Count	Existing GSF
The Gardens F	42	33,535
The Gardens G	42	33,535
The Gardens H	42	33,535
The Gardens J	42	33,535
The Gardens K	42	33,535
The Gardens L	42	33,535
The Gardens M	42	33,535
The Gardens N	42	33,535
The Gardens P	42	33,535
The Gardens Q	42	33,535

DINING



Dining is an important social aspect for campus users. It provides opportunities for students, faculty and staff to meet new people and interact with individuals outside of their academic programs or residence groups. With more than 20 locations on campus, and over 50 different dining concepts, there is a robust food service operation on the A&M campus. Texas A&M University has an agreement with a third-party provider to outsource food and dining services for the campus community. The agreement is based on the University providing physical space for the third-party provider to operate within.

Eastern Campus: Most of the on-campus dining is located in the east areas of campus within the Historic Core, Northside Housing and Academic, and Southside Housing and Academic Character Zones. These zones are also where a majority of residence halls, academic classrooms and student services are located. The result is a highly energized hub of activity that serves thousands of students per day.

Food Deserts: Even with the large amount of food services, A&M is unable to provide hot meal food service to all campus users within an acceptable distance (approximately ½ mile). This results in “food deserts” - areas of the campus that are underserved in terms of dining facilities for its users. Food deserts result in daily campus users leaving campus to purchase food from off-campus businesses and forces on-campus residents to use campus transit in order to access meals using their required meal plans. Food deserts exist in the west areas of campus and Research Park where the populations are lower than on the east of campus. As campus development occurs, and populations grow, expanded food services will be needed in these areas.

The following are existing food venues on campus categorized into types of food services offered. These range from full service dining, to grab-and-go food kiosks, to convenience stores. In order to create an equitable campus experience, there should be a mixture of each of these services offered within each character zone.

- **Food Court:** Multiple food options located in one space, mixture of private retail vendors such as Smashburger and Chick-fil-A. Located at Sbisa, Memorial Student Center, and Biology/Biochemistry Building.
- **Buffet Style Dining:** All-you-care-to-eat style dining. Located at Duncan, Sbisa, Rudder, and the Commons.
- **Snack Bar:** Offers hot meals such as burgers, chicken sandwiches, chicken fried steak, soups, and salads. Located at Pavilion, Vet Med, Food Trucks Row and Langford.
- **Kiosk:** Coffee, pre-made grab-and-go options such as sushi, sandwiches, salads, soups, and pastries. Located at West Campus Library, Emerging Technologies and Economic Development Building, Allen Building.
- **Coffee Shop:** Coffee and pastries (limited food options). Located at Corps of Cadets LLC, Hullabaloo, Evans Library, Blocker Building and Sbisa.
- **Convenience Store:** On-campus convenience store. Located at Sbisa, Hullabaloo and the Pavilion.

Dining Venue Hours: Many of the dining venues that are located in less populated areas have limited hours on weekdays and are closed on weekends. The following diagrams illustrate four times per week (Wednesday breakfast, Wednesday lunchtime, Wednesday dinnertime, and Saturday dinnertime) and what food services are available at those times. On-campus residents dependent upon meal plans have limited food choices during certain times of the week, which reinforces the intensity and impact of the food deserts on campus. Residential populations should be considered when planning out hours of operation, and each residential cluster should be accommodated during regular meal times.

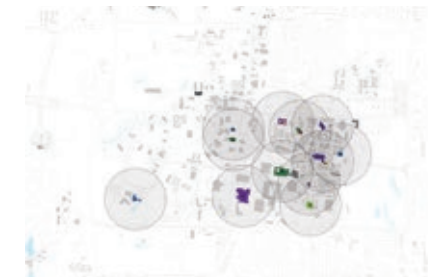

Wednesday 8:00am

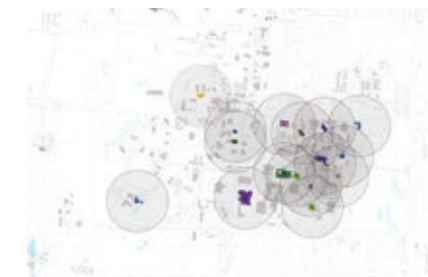

Wednesday 12:00pm

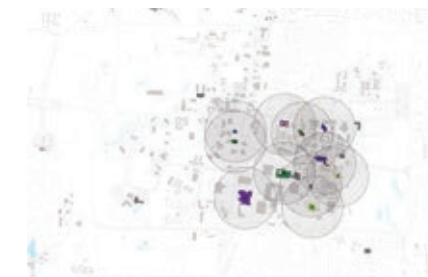

Wednesday 6:00pm



Saturday 6:00pm

Existing On-Campus Dining

- EXISTING FACILITY:
5-MINUTE WALK RADIUS
- TEMPORARILY OFF-LINE FACILITY:
5-MINUTE WALK RADIUS
- CONVENIENCE STORE
- FOOD COURT
- BUFFET STYLE
- SNACK BAR
- KIOSK
- CAFE

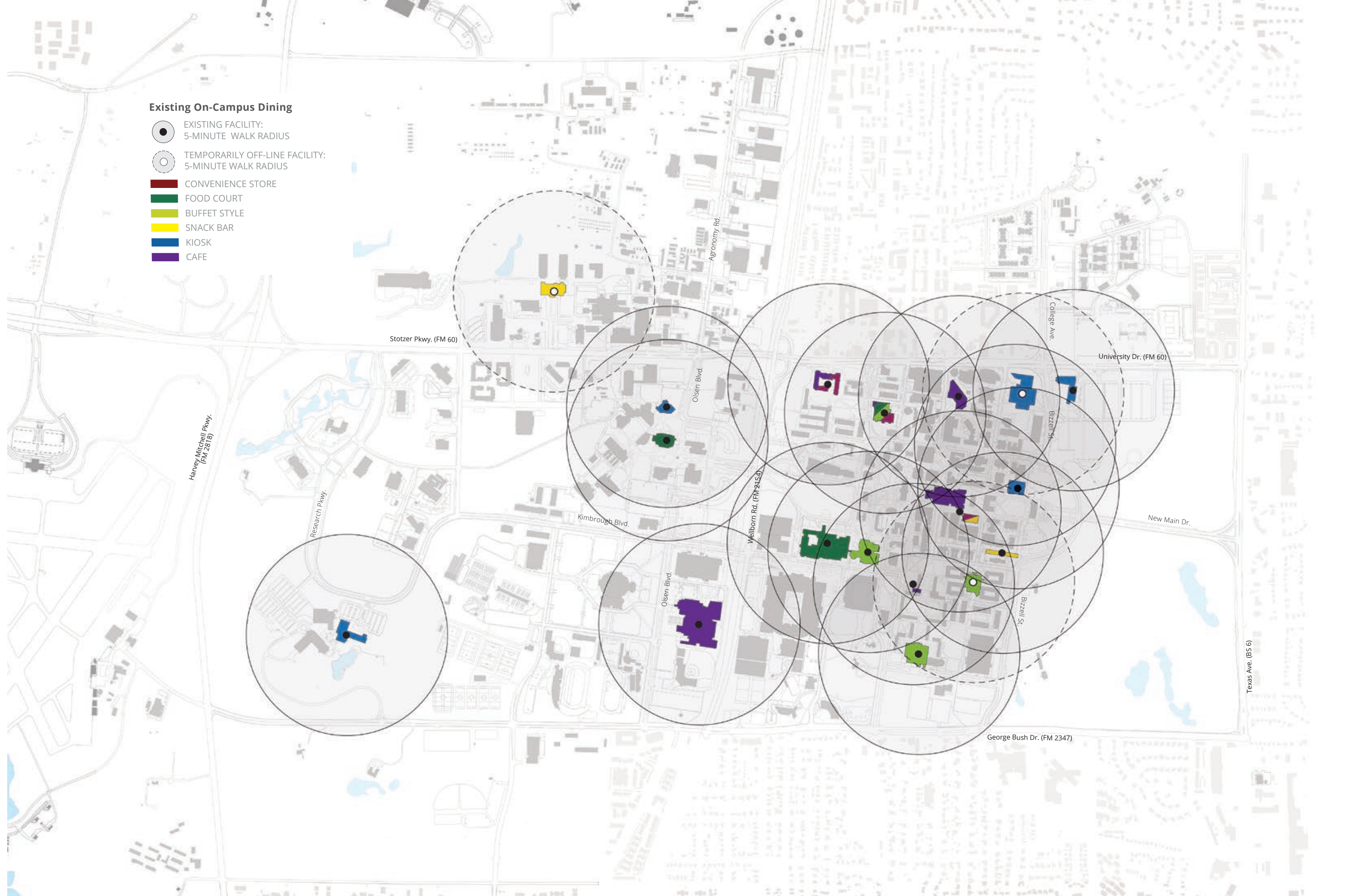

SIGNAGE

Current signage and wayfinding systems at Texas A&M University are an ad-hoc assembly that have been added to the campus over time. While the campus does have a signage standard, there are many one-off signs on the campus, complicating the order and hierarchy of the directional system.

The existing signage standard is homogeneous in its sign types. Building Identification Signs are the same color, size and scale as Vehicular Directional Signs. This standardized approach to all sign types impairs the necessary hierarchy of information needed to successfully navigate and understand the campus when walking or driving.

Campus Gateways are currently an assortment of different sign types ranging from large monument signs at the New Main Drive entrance and the intersection of Raymond Stotzer Parkway and Harvey Mitchell Parkway, the A&M logo placed on a rod iron fence at the intersections of University Drive and George Bush Drive and Texas Avenue, and no signage at the other major gateways into campus. With the lack of gateways signage, users rely on visual identity to feel a sense of arrival. These include the large open green space along Texas Avenue, J.K. Williams Building, Bonfire Memorial, Albritton Bell Tower, the Water Tower and Kyle Field.

Over time, the campus has added additional signs to the standard system. With so many individuals visiting the campus daily for academic occasions, sporting events, campus tours, etc., supplementary vehicular directional signage has been added to help visitors navigate to the parking lot and structures. Examples include the visitor parking sign placed in front of J.K. Williams Administration Building, which ruins an important vista for the campus, and the campus uses of temporary digital signage on major event days. In addition, several individual programs and precincts desire to have their own identification along campus edges or entrances. Along many campus edges, there are large monument signs denoting programs and precincts on campus. In some cases, these signs are larger than the

institutional gateway signage. This reversal in scale confuses campus users as to where the desired major campus entrances are located.

On-building signage uses a plethora of methods, including carving into the stone of the building, as well as a variety of different fonts and colors applied to the building at the main entrance. Naming of individual buildings is also inconsistent. Some buildings display only the name of their program, such as the Reynolds Medical Sciences Building, whose signage reads 'College of Medicine Rangel College of Pharmacy', while others display only the building name, such as the E.L. Wehner Building which houses the Mays School of Business.

A new version of building identification signage has recently been placed on campus, at Memorial Student Center and White Creek Apartments.

Recommendations for signage and wayfinding improvements, and a coordinated system of signage types can be found in Chapter Eight of this document.



Existing Building Identification Sign, Anthropology Building



Existing Vehicular Sign



Existing Parking Lot Identification Sign



Existing Gateway Monument Sign at Texas Avenue and New Main Drive



Existing Monument Signage located on Raymond Stotzer Parkway



Visitor Parking sign placed in front of J.K. Williams Administration Building, which is an important vista for the campus.



Existing Gateway Monument Sign at Texas Avenue and University Drive



Existing Monument Signage located on Raymond Stotzer Parkway



Existing Building Identification Monument Sign, Memorial Student Center



Existing On-Building Signage



Existing On-Building Signage



03

CAMPUS DEVELOPMENT PLAN

- Campus Development Plan Overview
- Open Space Network
- Character Zones
- Framework Schema
- 2017 Campus Development Plan
- Character Zone Studies
- Housing
- Dining
- Public Art
- Forums
- Implementation



The Campus Development Plan reflects a culmination of the planning and engagement processes, incorporating the constituent parts of the Focus Elements into a holistic plan to guide the ongoing growth of Texas A&M University.

While it represents a snapshot in time, the Campus Development Plan is equipped with the ability to evolve with the changing needs of the institution. Expanding on the previous master plan, the Campus Development Plan seeks to prioritize the pedestrian environment and provide a parity of experience across the planning area.

The primacy of the pedestrian environment and experience entails a focused planning effort aimed at enhancing the quality, and expanding the quantity, of space between built structures. The planning effort and its outcome is less about new buildings and more about the space in between; how these spaces encourage a campus supporting an active community of learning and discovery. Three strategies direct the advancement of the Campus Development Plan: the Open Space Network, Character Zones, and the Framework Schema.

These interrelated strategies each inform one another while also providing distinct aspects to the Campus Development Plan. The Open Space Network establishes a mosaic of spaces and linkages to tightly connect the campus across its extents and demonstrates appropriate locations for future

structures. The Character Zones set criteria for the appropriate physical aspects of these potential structures in relationship to their specific campus location. Finally, the Framework Schema unites these strategies together at a campus-wide scale while accentuating intersections of opportunity.

Each of the other five Focus Elements also provide influential input into the resultant Campus Development Plan. The focus elements contribute to the Campus Development Plan both at the macro and micro scales. Items such as proposed multi-use paths link the campus while new building signage reinforces the identity and brand of Texas A&M. The Focus Elements and their supporting campus systems are covered in greater depth in their corresponding report chapters.

Additionally, three specific topics that deal with location and programmatic aspects of the campus emerged through the Campus Master Plan process. Each of these relate closely with the Campus Development Plan and are covered in greater depth at the end of this chapter. These topics are:

- Student Housing's inclusion of amenities to support success
- Dining's availability and access across the campus
- Forums to broaden the Interactions of the campus community



The Campus Development Plan

illustrates a build-out scenario that responds to the reasonable carrying capacity of Texas A&M's site. The building orientation and density shown will support the university in developing a high performance campus.

OPEN SPACE NETWORK

Driven by a consensus to continually improve the campus environment, the campus community identified the University's Open Space Network as an aspect of particular emphasis to both enhance and expand. Future campus development and growth will be guided by the creation of new open space and the enhancement of existing open spaces. Together, this will help support an enriched campus experience.

The Open Space Network is comprised of a variety of scales, uses, and physical elements that define a diverse set of landscape typologies. Texas A&M is endowed with a wealth of landscape typologies includes a range of elements from native species to man-made settings.

The balance between built and non-built areas of campus defines the Open Space Network, resulting in the identity and character of campus that is experienced by students, faculty, staff, and visitors. As a reflection of the University's values, the Open Space Network sets the tone for an individual's first impression of the campus. This, in conjunction with feedback through extensive campus engagement, has set the priority of utilizing the Open Space Network as the primary tool to influence and direct the planning effort. This emphasis also closely aligns with the aspiration of the Mobility and Safety focus element to promote a pedestrian-oriented campus.

In order to achieve an expanded and enhanced Open Space Network, the 2017 Campus Master Plan establishes the programs and amenities necessary for successful open spaces. The open space programs identify primary uses for spaces while the amenities outline the necessary physical characteristics to support these uses. Currently, numerous open spaces across the campus are essentially leftover areas that resulted from past priorities focused on the construction of buildings. These spaces have no identified primary use nor do they have the appropriate level of amenity to support potential uses. Aligning programs and amenities to these spaces will create new use and activity, improving the overall campus experience. Refer to Section 06: Campus Guidelines for more detail regarding the proposed programs and amenities.

While the campus includes excellent examples of open space that are supported by appropriate programs and amenities, it does not contain a level of parity reflected across its extents. For example, Military Walk is a cherished and iconic part of the campus while the unnamed malls north and south of Evans Library lack the necessary amenities to support their use as significant thorough-fares linking Academic Quad to East Quad. This offers a prime example for potential enhancement through modest intervention to incorporate amenities conducive to its current program use. As the west portion of campus continues to see future development, it presents a meaningful opportunity to create new open spaces to support its growth and further link areas of campus.



Mall North of Evans Library



Open Space Network

CHARACTER ZONES

The 2004 Campus Master Plan utilized District Plans that combine academic program and physical campus elements together to plan smaller areas of the campus in more detail. In contrast, the Character Zones defined in this Master Plan focus solely on the physical campus elements within their specific boundaries.

These physical elements cover a range of campus planning issues, such as density and siting, to building design issues, such as massing and materiality. This allows scales of application and detail that range from campus-wide to site or building specific.

Considered in conjunction with the Campus Guidelines, the Character Zones allow the distinct aesthetics that have emerged over time in specific zones to continue while also identifying the necessary elements that will allow the campus to maintain a cohesive appearance across its extents. For example, the Athletics and Recreation Zone is characterized by a distinct brick color found primarily within its boundary, but might also utilize a stone material that can be found across the entire campus.

The boundaries between zones are not hard edges, but instead are bridged by common elements such as building materiality, landscape amenities and signage that serve to create a consistent palette that can be applied to unify the look and feel of the campus. The zones also support conserving the heritage of the built environment by designating appropriate densities, building heights, and other relevant massing issues to harmonize with the existing buildings and context.

The Open Space Network and the Character Zones work in union with the Campus Guidelines to support the creation of a campus environment that is accommodating of institutional needs and reflective of the identity and values of Texas A&M University.

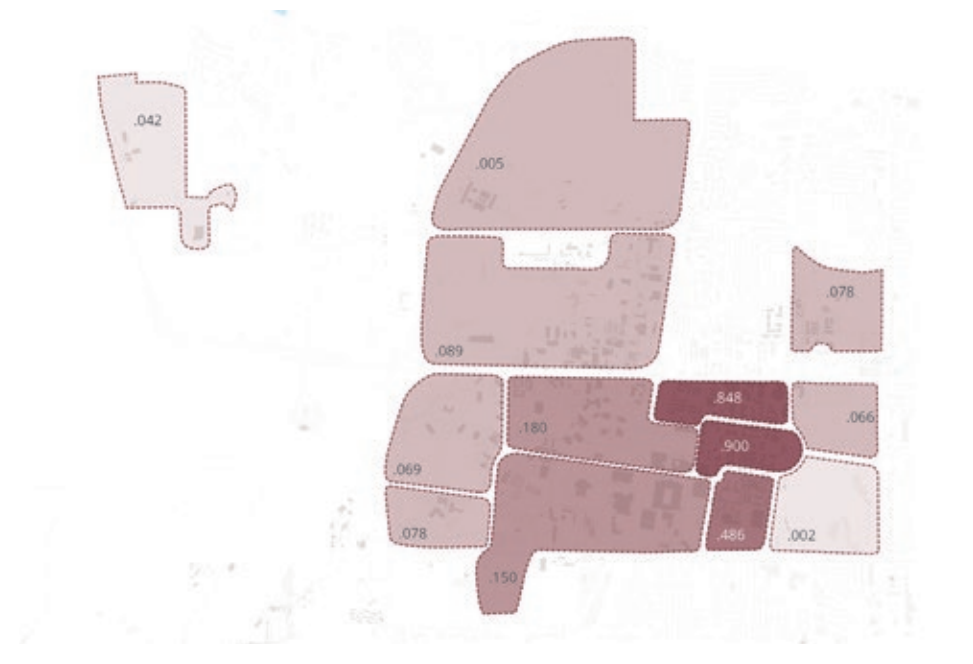

Existing Floor Area Ratio per Zone (Measure of Density)

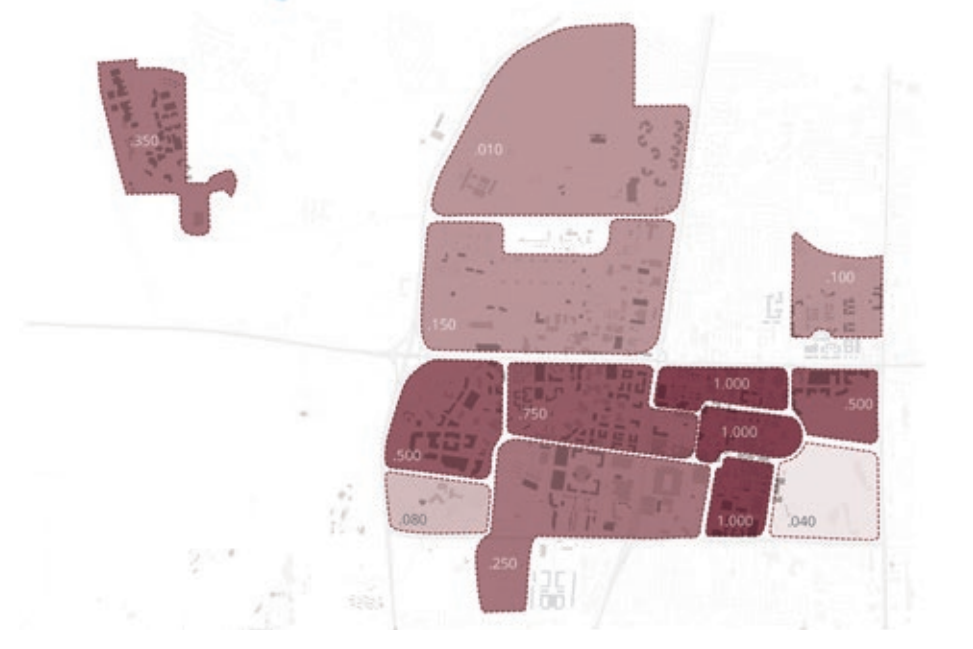

Planned Density (Floor Area Ratio)

1.00+
0.50 - 0.99
0.25 - 0.49
0.10 - 0.24
0.05 - 0.09
0.00 - 0.049

Planned Floor Area Ratio per Zone (Measure of Density)



Character Zones

- Hensel Park
- Campus Front
- Campus Entry & Golf Course
- Southside
- Historic Core
- Northside
- West Campus
- Athletic & Recreation
- Bush Library
- Research Park
- University Dr. & Agronomy Rd.
- F & B Road
- Health Sciences Center

FRAMEWORK SCHEMA

The Framework Schema is a conceptual diagram that identifies the key linkages and connections across campus. Ideas such as strong axial organization and the Civic Structure developed in the 2004 Campus Master Plan are continued by the Framework Schema by developing an axis through West Campus to terminate at the Duck Ponds in Research Park.

The secondary parallel lines of influence to the axis found in the 2004 Campus Master Plan are extended, modified, and supplemented with additions in the 2017 Campus Master Plan Framework Schema to reflect campus growth since 2004 and influence future growth. Not included in the 2004 Campus Master Plan, vertical lines of influence are added into the 2017 Framework Schema to reflect both current campus conditions, direct future changes, and extend the 2004 Civic Structure to encompass the entirety of the campus planning area.

While depicted in an orthogonal grid pattern, the application of the schema is not intended to impose rigidity to the campus. Natural features such as White Creek intersect the Framework Schema and indicate potential areas of access to creek area amenities. Likewise, pedestrian and bicycle pathways may meander through campus with points of redirection occurring at intersections with the Framework.

With the various linkages and connections identified by the lines of influence, specific areas of interest are highlighted at their intersections. These nodes indicate prime locations for open spaces – either new or enhanced - that directly support the Open Space Network. Frequently, these nodes and lines of influence also inform critical connections between the Character Zones.

Similar to the strong relationship between the Open Space Network and the Character Zones with the Campus Guidelines, the Framework Schema works with various aspects of the guidelines to direct future campus development. For example, the framework will guide siting of buildings, influence their massing, and assist with identifying appropriate points of entry.

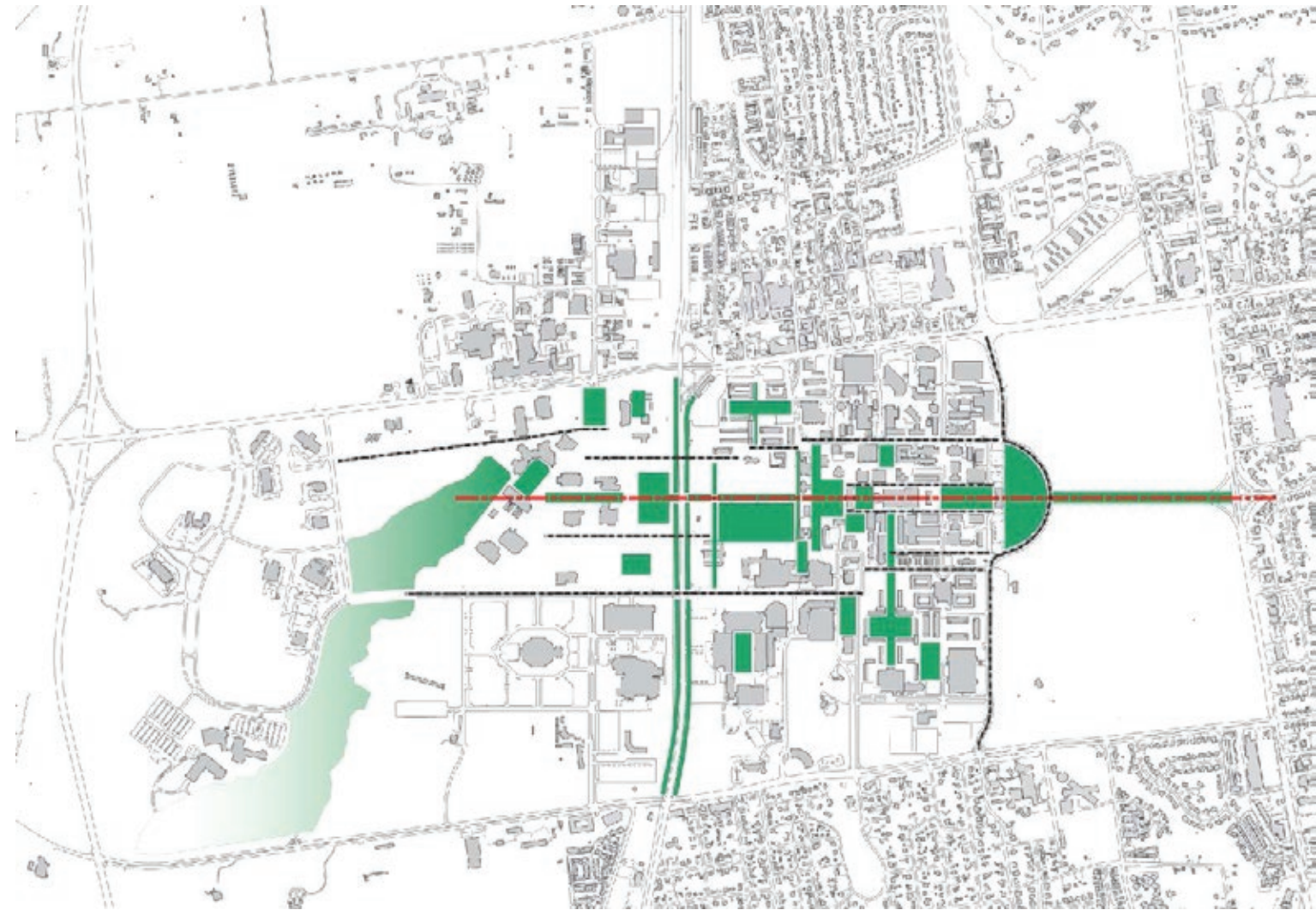

Civic Structure from the 2004 Campus Master Plan



Framework Schema

- Civic Structure
- - - Secondary Framework (E-W)
- - - Secondary Framework (N-S)
- ⚙ Terminus/Node

2017 CAMPUS DEVELOPMENT PLAN

Working within many of the existing conditions found on campus, the 2017 Campus Development Plan undertakes a series of thoughtful interventions to improve the campus experience by expanding the Open Space Network, increasing pedestrian-oriented zones, and strengthening the physical and interdisciplinary connectivity across campus.

Northside

This zone includes residential and academic components, particularly facilities related to the Engineering program. Future selective demolition and infill of academic buildings, along with the current expansion of the Engineering Education Complex, will support program growth associated with the College of Engineering 25 by 25 Initiative. The plan also looks to enhance student life in the Northside residence halls through the creation of new expanded student lounges. Key to the northside is an array of new open spaces within the residential and academic areas aimed to enrich the campus experience. These include both new and expanded quads, an improved pedestrian and bicycle campus gateway at Houston Street, and the conversion of Spence Street into a pedestrian mall that projects into the heart of the Historic Core.

Historic Core

The Historic Core contains a majority of Texas A&M's heritage buildings and some of its most cherished spaces. Selective replacement and infill will preserve and enhance these important campus resources while also pursuing the highest and best use of the available growth opportunities in this zone. Preserving and expanding upon open space and green space is paramount for the development of this zone. Improvements are planned to open areas such as Cushing Quad, the Evans Library Malls and the J.K. Williams Administrative Building East Lawn. Further, quality new open spaces can be created in the core by replacing small parking lots, helping to enrich the overall character of the zone while also improving the experience for pedestrians. These new spaces integrate improvements to primary pedestrian paths to streamline movement and provide a more comfortable and shaded environment for campus users.

Southside

Transformation is already underway in the Southside with renovations to the Corps Quad and Corps dormitories, the expansion of student lounges, new leadership learning centers that serve the entire student population, and a major renovation to the Commons Building. Future opportunities for growth in the zone exist south of Lewis Street. The Campus Development Plan includes infill of the existing surface parking with residence halls and structured parking on these sites, specifically coordinated with current plans for the relocation of the band practice facilities and field along with the construction of a new Music Activities Center.

Campus Front

The 2011 construction of the Emerging Technologies Building signaled the start of campus development east of Bizzell Street. The 2017 Campus Development Plan presents a long-term vision for a coordinated expansion in this area that respects the siting of the Bonfire Memorial and Bonfire Memorial Trees. The intended use of future development in the Campus Front will be primarily academic-focused with the ground level retail and dining. Open space enhancements include shaded pedestrian pathways and a new landscaped campus gateway at the corner of Texas Avenue and University Drive.

Athletics and Recreation

The 2017 Campus Development Plan leverages the replacement of major surface parking lots with parking garages within the Athletics and Recreation zone to allow for the development of additional academic facilities, expand athletics facilities in line with the 2013 Athletics Facilities District Plan, and create open spaces suitable for large events such as Fish Camp. Key circulation improvements include a recommended grade separation at Penberthy Road to provide safe access to the new recreation fields south of George Bush Drive and a multi-use path extending from Reed Arena west to connect to the proposed development at Research Park.

CDP Building Legend

- Proposed Buildings
- Proposed Parking Structures
- Existing Buildings
- Existing Parking Structures
- Partnership Buildings
- Off Campus Buildings



West Campus

West Campus is currently undergoing considerable changes that will begin to activate currently undeveloped areas within the zone. The Gardens project will be a major addition to the Open Space Network, and the future phases of White Creek Housing will greatly increase West Campus residency and activity. The Campus Development Plan incorporates these two projects and builds upon their momentum by proposing conversion of numerous large parking lots into academic space, and selective demolition and infill of underutilized areas. Structured parking will also be built on existing surface lots, sited to support West Campus' residential, athletic, and academic precincts.

Research Park

As one of the most underdeveloped areas on the campus, Research Park creates opportunity for coordinated development of an innovation complex that the University can utilize to foster strategic partnerships with industry and research. Through a realignment of Research Parkway and Kimbrough Boulevard and subsequent infill to the north, the entirety of Research Park will be supported by a network of pedestrian linkages and open spaces that align with the Framework Schema. Support and service spaces currently housed in Hensel Park are relocated to an area within Research Park.

Hensel Park

Because of its location at the intersection of College Station, Bryan, and the University, Hensel Park is both a campus and community asset. The park currently serves as a buffer between the community and student housing developments, but opportunity exists to enhance the park through the provision of added amenities such as playing fields, water features, playgrounds and an improved system of trails. The plan identifies new mixed-use development along South College Avenue, providing for a close proximity to dining opportunities. A new point of entry is located along Texas Avenue, marked by a new event center with both indoor and outdoor space. Finally, there are potential expansion opportunities for the daycare center, student housing, and community facilities.

University Drive and Agronomy Road, and F and B Road

These zones incorporate district plans commissioned by both the College of Veterinary Medicine and Biomedical Sciences and the College of Agriculture and Life Sciences along with projects currently in design or under construction. Landscaping and tree plantings along Agronomy Road up to the General Services Complex building will enhance this highly utilized corridor.

Health Science Center

This plan incorporates the 2008 Health Science Center (HSC) Campus Master Plan and Design Guidelines. Accommodation is made in the Campus Development Plan and Open Space Network for suggested landscape enhancements along F and B Road and Traditions Drive to support cyclists traveling between campus and the HSC. As portions of these roads lie outside campus property, cooperation with the City of Bryan will be needed to carry forward any landscape, bike route, or pedestrian improvements that may be considered.

Campus Entry and Golf Course

This area is not targeted for significant development within the planning horizon of this plan. However, the Campus Development Plan presents a suggested scheme for initial expansion into this area that includes development for recreation, academic, dining, and services.

Bush Library

The Bush Library zone is home to the George Bush Presidential Library and Museum, and is managed by the George Bush Presidential Library Foundation. This area has been factored into planning elements such as circulation, dining, and stormwater management. Future development proposed within the 2017 Campus Master Plan is limited to a single new structure that will house George H.W. Bush's Marine One helicopter and a dining facility.









Northside

The Northside character zone is located between the historic core of campus and University Drive. The zone is comprised of a blend of housing, academic, research and facilities programs and is loosely defined by a border of University Drive, Wellborn Road, Ross Street and Bizzell Street. The area is characterized predominantly by brick and stone buildings that range from two to twelve stories (Petroleum Engineering Building). Many of the buildings in this zone are considered heritage or historic, such as Milner (1911), Sbisa Dining Hall (1912), Walton Residence Hall (1931), Civil Engineering Building (1932), Halbouty Geosciences Building (1933), All Faiths Chapel (1957) and the Dorherty Building (1960). Recent projects include the Hullabaloo Residence Hall (2013) which includes over 600 beds and many amenities such as study lounges, a café, and convenience store for on-campus residents. The Zachary Engineering Education Complex is currently being renovated and expanded to become a 500K GSF state of the art educational complex for the College of Engineering. Buildings in this zone are organized along the existing street grid and typically face internal street edges. Differing from the civic structure of the historic core, buildings in this zone do not form traditional collegiate green spaces. Instead, the areas between buildings are dedicated to surface parking lots or underutilized plazas, neither of which contribute positively to the overall open space network.

A major driver of this planning effort is to create quadrangles, courtyards and pedestrian malls adjacent to new and existing buildings. The balance between built and non-built areas of campus defines the Open Space Network which results in the identity and character of campus experienced by students, faculty, staff and visitors. In the Northside, new planned development is a thoughtful balance of both buildings and open space. Approximately 1M Gross Square Feet of housing, academic and research programs will be built in this zone, increasing the density to better align with a traditional urban campus. Additions to Halbouty and Dorherty will be demolished to make way for new open space. Existing buildings will also be used to shape enhanced green spaces in the housing precinct, adjacent to Zachary Engineering Education Complex, and adjacent to Halbouty.



Proposed Green Space at Northside Housing Precinct



Proposed Green Space at Northside Housing Precinct

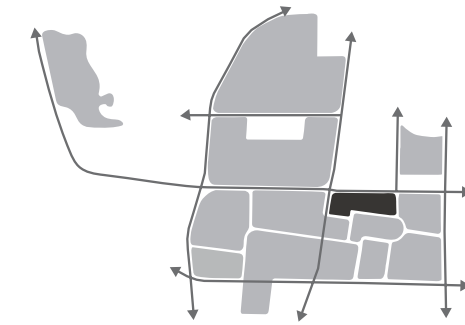

Northside By the Numbers:

98

Acres

3.62M

Existing Gross Square Feet

690K

New Gross Square Feet

0.85

Existing FAR

1.00

Planned FAR

3,500

Existing Parking Count

3,800

New Parking Count

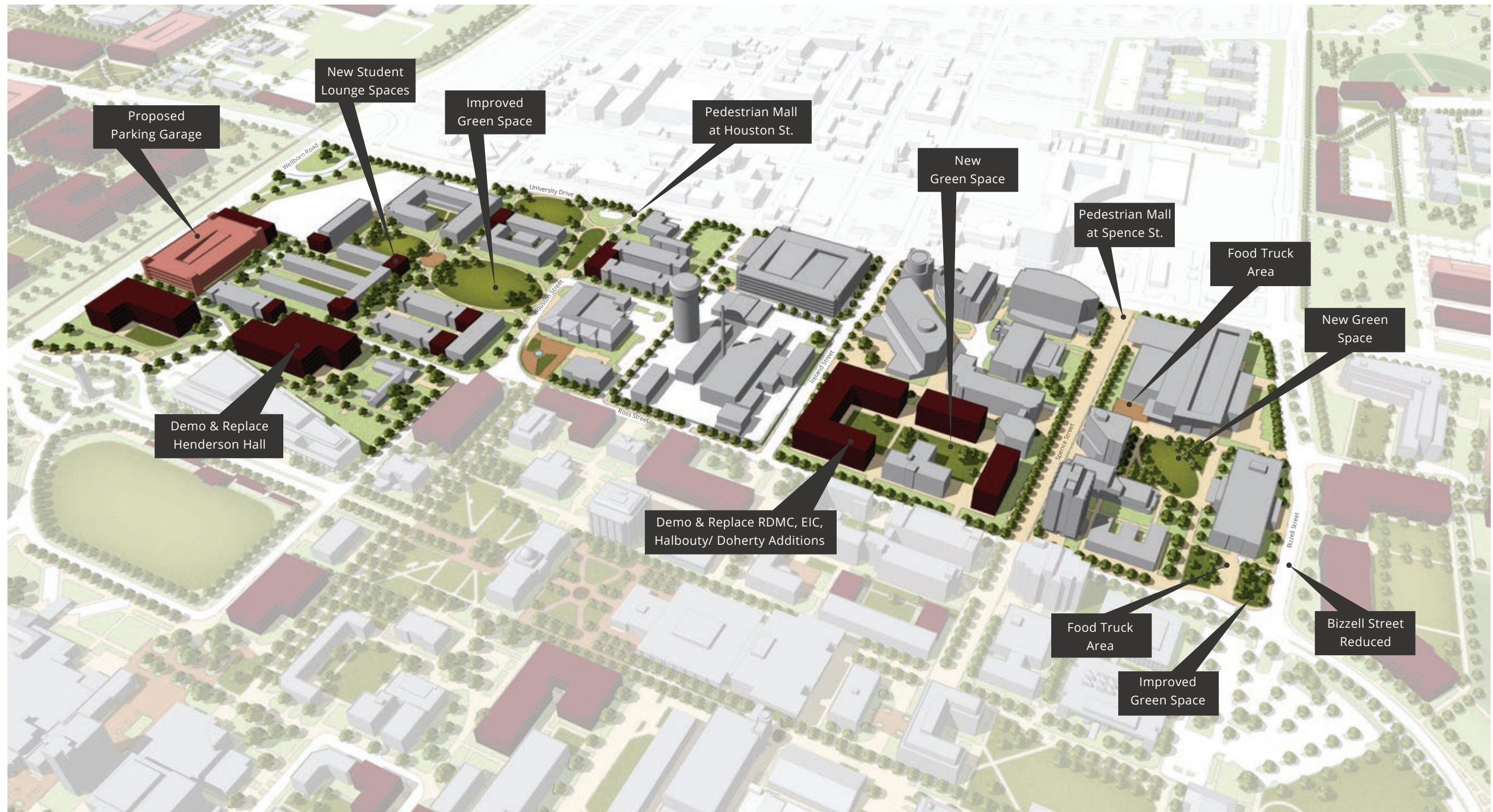

Northside: Proposed Scenario

With 65 classrooms containing over 4,000 seats, the Northside is one of the most concentrated areas to the campus in terms of transient use. In addition to the academic foot traffic, the Northside also contains one of the largest housing precincts on campus with more than 3,500 beds. In order to accommodate the large amount of pedestrians populating the zone, the planning effort aims to make the pedestrian the priority, while private vehicles become secondary. The alterations made to Ross Street have been one of the most successful projects implemented since the 2004 Campus Master Plan. Ross Street is a limited access road closed to private vehicles during busy class hours, successfully giving priority in this area to pedestrians and cyclists. To continue the pursuit of a more pedestrian-friendly campus, many roadways in the Northside will be altered to remove or reduce the use of personal vehicles and create a safer environment for pedestrian users. Both Spence Street and Houston Street, from University Drive to Ross Street, will become pedestrian malls and will no longer allow vehicular access into campus. These roadways will still be accessible to credentialed service and emergency vehicles.

Similar to Ross Street, Asbury and Ireland Streets (from University Drive to Ross Street) and Jones Street (from Houston Street to parking lot 30e) will become limited access. These streets will not be accessible to private vehicles during busy class times, but will be open to all vehicular traffic in evenings. As parking is shifted to the periphery of the campus, Bizzell Street will no longer act as a major access point into the campus. In order to reduce and calm traffic, Bizzell will be reduced from four lanes to two lanes (from Polo Road to Ross Street) with enhanced crosswalks to improve its connection to parking and programs located east of Bizzell Street.

To improve safety and connectivity, the bicycle network will include:

- Bike lanes along Spence and Houston Streets (now pedestrian malls)
- Buffered Bike Lanes along Bizzell, New and Ireland Streets
- Multi-use Paths will be added along Ross and Asbury Streets

A new parking garage located adjacent to the housing precinct will accommodate relocated surface parking spaces while also adding additional spaces. This re-balancing will result in a 9% increase in parking in the zone while providing space to create new greenspaces, open spaces, and amenities.

Unique to this zone is its urban edge of the campus along University Drive. Setbacks from University Drive should be regulated to approximately 50' from the street edge. Within the setback, enhanced landscape and a 14' multi-use path will help to create a safe and aesthetic urban edge that will enhance the University's identity.



Proposed Pedestrian Mall at Spence Street and University Drive



Historic Core

The Historic Core of the campus is the original area of the University dating back to the end of the 19th century. The zone can be loosely defined as bordered by Ross Street, Bizzell Street, Lubbock Street and Wellborn Road. The area is predominantly brick and stone buildings that range from one story to sixteen stories (O&M Tower). Many of the buildings that are still present within the zone date back to as early as 1909. Nearly half of the buildings are considered Heritage or Historic, notably including Nagle Hall (1909), Academic Building (1914), J.K. Williams Administration Building (1932), and the Memorial Student Center (1951). The civic structure of the campus was formed through the creation of the buildings located in the Historic Core, and the outdoor public spaces created by these forms are equally considered a historic resource. These spaces include Simpson Drill Field, Cushing Quadrangle, Academic Plaza, East Lawn and Military Walk. The Historic Core has many features of a typical American campus including a dense concentration of academic programs, an administrative building, student center, and library centered within. The Historic Core was developed as a compact campus with a clear system of streets, malls, and quadrangles which are framed by buildings that are human in scale, have clearly defined entrances, and sited to create space. The proposed campus-wide Open Space Network draws inspiration from the Historic Core to create outdoor space throughout the campus based on these concepts of compactness and organization. *For a complete list of Level One Heritage or Level Two Historic buildings and Outdoor Spaces, see Chapter 7 Heritage Conservation.*

There are many buildings that are planned to be conserved within the Historic Core as per the Historic Resource Inventory and Assessment, which results in less opportunity for infill compared against other character zones. For this effort, the planning team has explored selected infill opportunities which would exist only by demolishing existing buildings. Although these buildings may be considered historic because of their location in the Historic Core Zone, there are instances in which demolishing the historic resources would be more beneficial to the overall program of the campus. The 2017 Campus

Master Plan is not identifying any buildings to be demolished. Instead, certain buildings were selected to be assessed based on three categories: low density, low on the FCI index, or how present growth opportunities relate to the site. These buildings are: Old State Chemist Building, Thompson Hall, Engineering Activities Buildings, TAES Annex, and Biological Science Building West and Biological Sciences Building East. Any building that is being considered for demolition must be assessed through the Heritage Conservation Guidelines for Demolitions. Before a building is confirmed to be demolished, alternatives to demolition such as adaptive reuse, preservation, rehabilitation, restoration or reconstruction should be explored. This also includes non-historic buildings identified as infill such as Beutal Hall and Heaton Hall. *For more information on the demolition process, see Chapter 7 Heritage Conservation.*

There are also a select few sites located within the zone that do not require demolition of historic resources, including the open sites flanking Old Main Drive along Wellborn Road. These sites offer opportunities to create large academic buildings that begin to visually and perceptually close the gap between the east and west portions of campus.



As a major campus civic space, Simpson Drill Field straddles the Historic Core and West Campus, and as development occurs to the west it is becoming the center of the campus

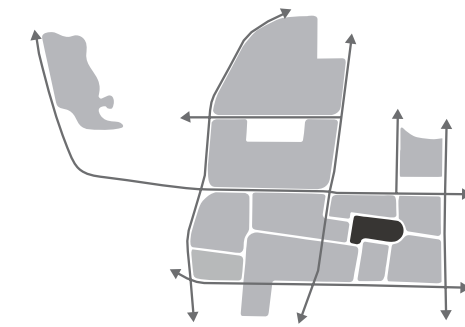

Historic Core By the Numbers:

95

Acres

4.41M

Existing Gross Square Feet

1.1M

New Gross Square Feet

0.91

Existing FAR

1.00

Planned FAR

3,300

Existing Parking Count

2,700

New Parking Count

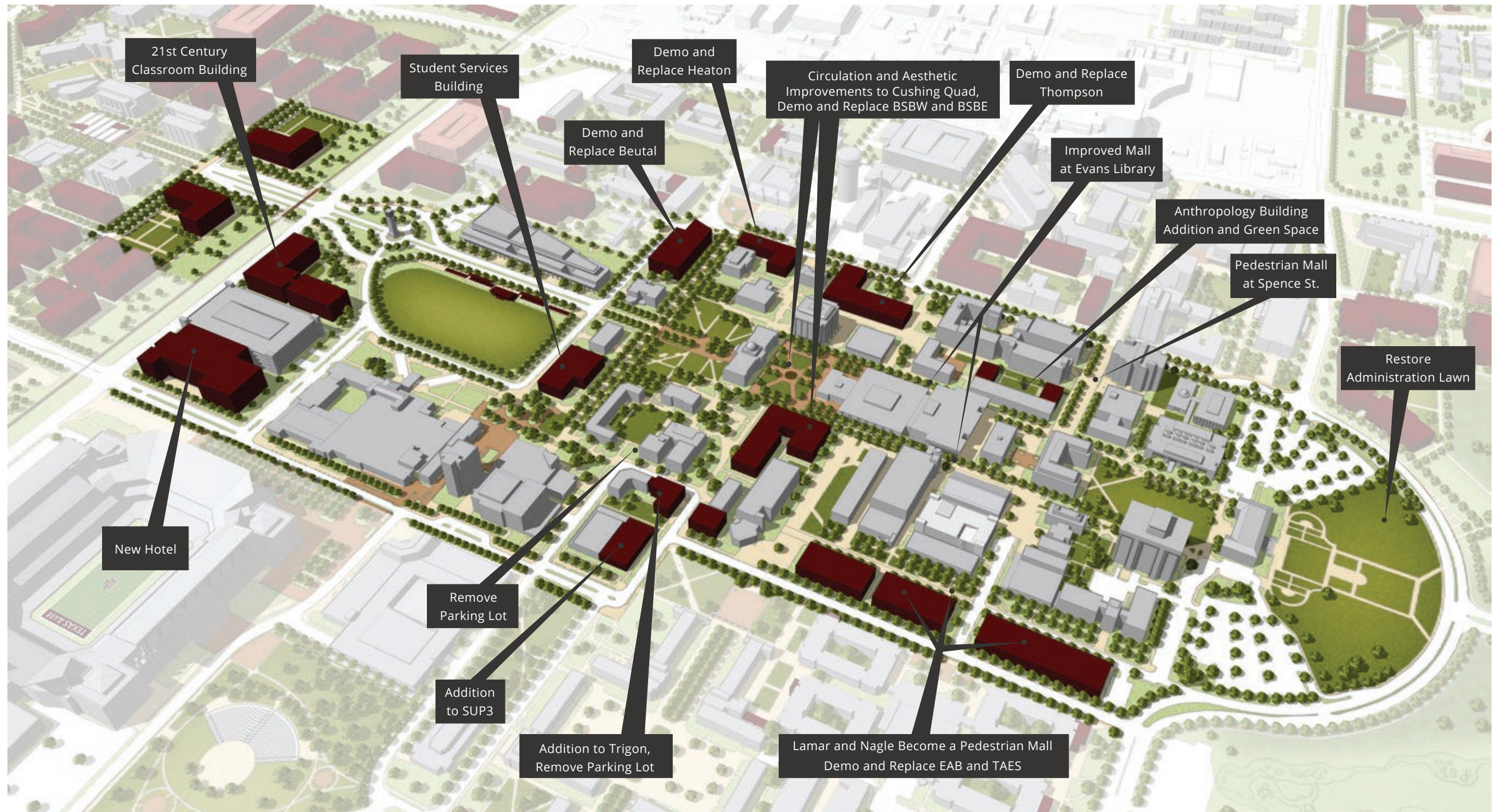

Historic Core: Proposed Scenario

A major driver in the Campus Master Plan is to strengthen campus cohesion. In the built environment, this is achieved by activating interior ground floor spaces, providing seamless pedestrian walks with quality gathering spaces, and easing the transition between these indoor and outdoor spaces. By activating the exterior ground plane and improving the pedestrian experience, stronger campus cohesion can be achieved across the broader landscape. Softscape should aim to enhance both the natural and designed beauty of the campus landscape. In key locations within the Historic Core, softscapes spaces should be updated and strengthened. For example, many of the historic spaces on east campus such as Cushing Quadrangle, the Malls to the north and south of Evans Library, and Simpson Drill Field are long overdue for restoration and rehabilitation.

The Historic Core is the most heavily-used pedestrian area of the campus due to the large number of classrooms, student services, and amenities. There are 94 classrooms with close to 6,000 seats in this zone. It is the most concentrated area of the campus in terms of transient use. In order to accommodate the large number of pedestrians that populate this zone, the priority is to further accommodate the pedestrian and cater less to private vehicles.

To continue the pursuit of a more pedestrian-friendly campus, various roadways in this zone will be altered to remove or reduce the use of personal vehicles. Spence Street (from Ross Street to the Animal Industries Building), Lamar Street (from Spence Street to Nagle Street), and Nagle Street (from Lubbock to Evans Library) will become pedestrian malls that will no longer allow vehicular access deep into the campus core. However, these roadways will still be accessible to credentialed service and emergency vehicles, as well as for special events. Lubbock Street (from Spence Street to Coke Street) and the Trigon transit loop will become limited access. Although, these streets will not be accessible to private vehicles during busy class times, they will be open to all vehicular traffic in evenings.



Mall North of Evans Library



New Pedestrian Mall at Lamar Street



Cushing Quadrangle, Evans Library Malls, Lamar and Nagle Street Pedestrian Malls

Small interior parking lots within the Historic Core will be replaced with new green space (Lots 6, 10a, 10b, 15, 19, 21, 22, 28 and Spence Street). These parking spaces will be relocated to adjacent surface lots or parking garages. Removing surface lots aids in reducing vehicle, pedestrian, and bicycle conflicts by encouraging vehicles to park on the edge of campus before entering the dense and heavily populated campus core. No new parking will be added in this character zone.

One of the biggest potential hazards to pedestrian safety is the sheer volume of cyclists that travel within the Historic Core during class change periods. The high number of bicycles, skateboards, and scooters mixes with extremely high pedestrian volumes to create a cacophony of movement that can often lead to collisions. To increase the safety of pedestrians in these areas, a dismount zone policy would force all riders off of non-motorized wheeled objects, such as bicycles, skateboards, and scooters to allow for pedestrian only movement. At Rudder Fountain, bicyclists are currently expected to dismount and push their bikes, making this area conducive for the large concentration of pedestrians. The recommendation is to slowly expand the existing dismount zone on campus over time to eventually cover the entirety of the Historic Core. This change cannot happen immediately, as its success relies on campus users to follow the policy. To accommodate additional bicycles outside of the Historic Core of campus, bidirectional bike routes are planned to loop around the dismount zone and enhanced/expanded bike lanes will be located on Ross Mall and down Houston Street.



Proposed Trigon Addition and Courtyard



Southside

The Southside character zone is comprised primarily of on-campus residence halls and the Corps of Cadets residence halls and programs. The zone can be loosely defined as boarded by Lubbock Street, Bizzell Street, George Bush Drive, and Thockmorton Street. The area is defined predominantly by brick buildings that range from one story (Lindsey Building) to five stories (Corps of Cadets Residence Halls). The buildings in this zone are predominantly from around 1962. The Corps of Cadets Residence Halls and Quad, built in 1938, are considered to be historic campus resources.

Organizationally, the Southside of campus creates a strong north-south framework extending from the original east-west civic structure found in the Historic Core. Enhancing these north-south linkages through greater connectivity and improved landscape will serve to tie the campus together from University Drive to George Bush Drive. One enhancement in particular is the connection from Duncan Dining Center to Evans Library, which currently exists as a roadway (Nagle Street) lined with reserved parking spaces. This link is aligned with the strong axis in the Corps of Cadets Quad, and extends from Lubbock Street to the heavily populated Evans Library Malls. Removing vehicles from Nagle Street and creating a new pedestrian mall leading from the Southside to Evans Library aids in stitching the framework of the historic core to the framework of the Southside through seamless and intuitive pedestrian movement.

Future growth within the Southside zone is concentrated south of Lewis Street. The block currently contains multiple large surface lots and one low density building. The Music Activities Center (MAC) will be the first program moved to the block – including a 80,000 GSF building that will accommodate the more than 1,300 student musicians who participate in the bands, choirs and orchestras at the University. This location will also include the Aggie Band practice field. The new facility will replace the E.V. Adams Band Hall to make way for a higher density building on that site. Lastly, the current Aggie Band practice field, Haney Drill Field, will be re-envisioned as a public green space for recreation, gathering, and training.

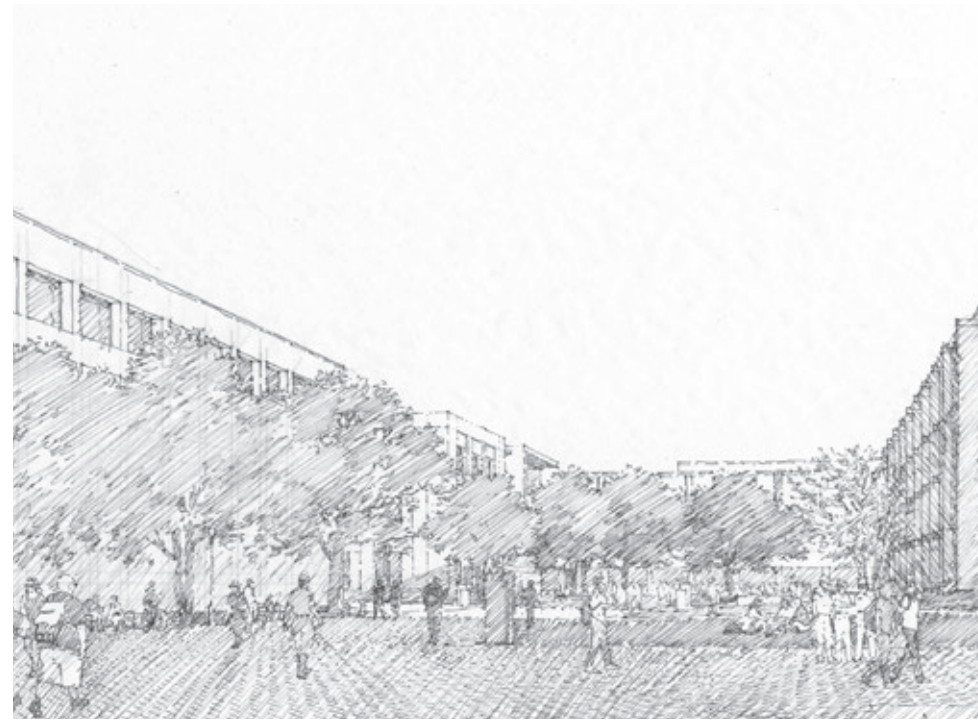

The conversion of Nagle Street to a pedestrian mall connects the Southside to the Historic Core of campus through a strong pedestrian access from Duncan Dining Hall to Evans Library.



Enhanced North-South Linkages

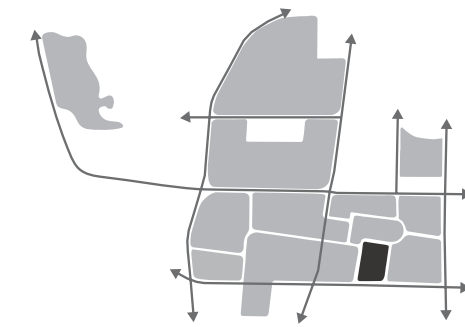

Southside By the Numbers:

80
Acres

1.70M
Existing Gross Square Feet

1.1M
New Gross Square Feet

0.49
Existing FAR

1.00
Planned FAR

3,400
Existing Parking Count

3,600
New Parking Count

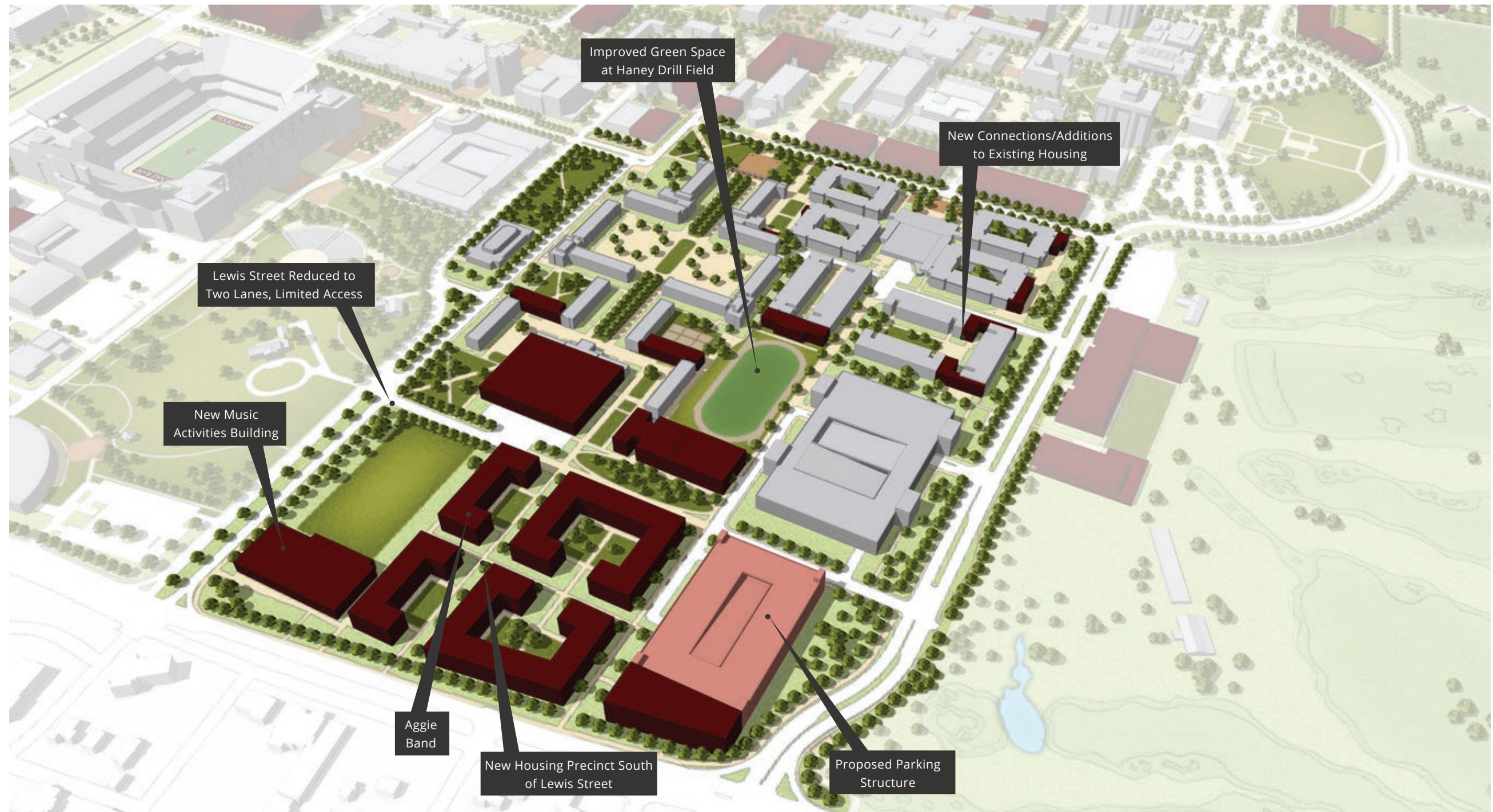

Southside: Proposed Scenario

As the Corps of Cadets grows in enrollment, additional housing will be needed south of Lewis Street to house the Aggie Band. As additional on-campus housing is demanded, the area south of Lewis offers potential for over 700K GSF of new on-campus housing (approx. 1,700 beds). Housing in the plan is shown as a balance between built and open space, with traditional quads interior to the housing which are connected to each other, and the broader Open Space Network, through malls. A strong north-south connection will be needed east of Duncan Dining Hall to connect the Corps of Cadets area to new development to the south.

A second planning scenario for south of Lewis Street includes an additional 1,200 seat music hall as part of the MAC program. This would be a standalone structure placed adjacent to the MAC.

The Southside housing precinct currently has over 6,000 beds. While many of the residence halls in the precinct are fairly old, they present opportunity to renovate and introduce new amenities, such as new and improved common spaces, rather than demolishing and rebuilding new. Recently the Corps of Cadets residence halls were fully renovated. Utilizing the approach above, new connections were built between the older buildings to house common space programs and leadership centers. The Quad was also renovated to better accommodate the activities and training of cadets. This 'rehab and connect' approach was a successful model for the Corps of Cadets dorms and is planned to be used as a model for other existing residence halls on campus.

As parking is shifted to the periphery of the campus and wayfinding improves with signed entrances, Lewis Street will no longer act as a major on-campus roadway. The roadway will be reduced from four lanes to two lanes and will intersect with a limited access road that aids in the pedestrian connection from the Corps of Cadets area to the new housing development. Access to the existing South Campus Parking Garage and proposed structure south of Lewis Street will be only from Bizzell Street. Access onto Lewis Street from

Coke Street is limited to service vehicles traveling to Duncan Dining Hall. By reducing the right of way of the road, there is an opportunity to provide a screened service area on the backside of Duncan Dining Hall.

Small interior parking lots will be replaced with new green space (Lots 26, 34, and 40a). These parking spaces will be relocated to adjacent parking garages. A new parking garage is planned to replace the spaces on surface lots south of Lewis in conjunction with the new housing development actualizing, resulting in a 5% increase in parking in this zone. Removing the surface lots aids in reducing vehicle, pedestrian, and bicycle conflicts by encouraging vehicles to park before entering the dense and heavily populated campus core.

In order to improve the safety and connectivity, the bicycle network will include Buffered Bike Lanes and Multi-use Paths along Lewis, Coke and Throckmorton Streets.

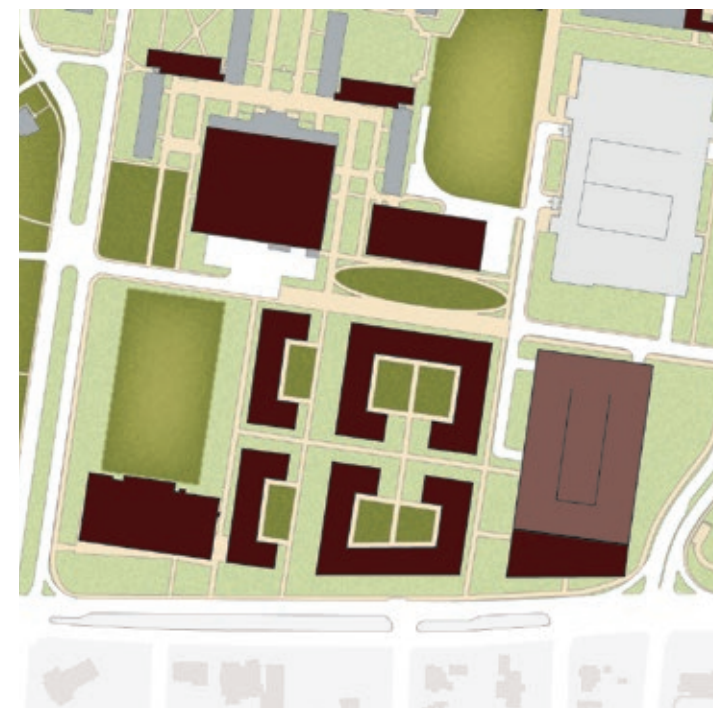

Southside Housing and Music Activities Center - Scenario 1

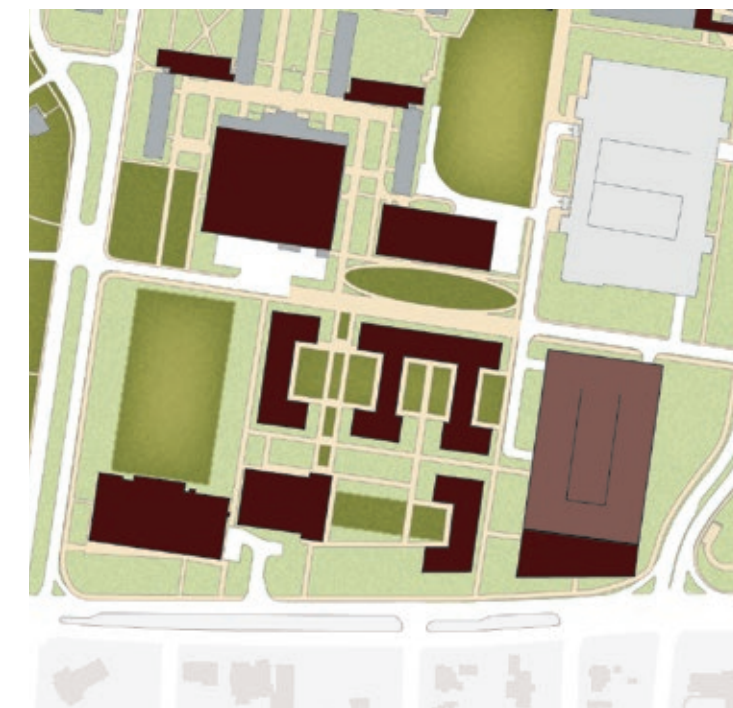

Scenario 2



Campus Front

Discussions during the planning effort identified various conflicts and challenges that occur in the area bounded by Texas Avenue, New Main Drive, Bizzell Street and University Drive. While a range of views were evident, the majority of participants believed that planning efforts should take into account the Campus Front. The priorities when considering the planning of this area included conserving campus heritage, strengthening the campus identity, and supporting appropriate uses.

This area is currently a composite of different uses including: the New Main Drive entry into campus, the Bonfire Memorial, the Bonfire Memorial Trees, significantly large surface parking lots, under-utilized playing fields, stormwater management, and the Emerging Technologies Building. The significant amount of surface parking east of Bizzell Street does not aesthetically support the desired identity or experience of the front to campus. The greatest conflict comes from pedestrian safety as individuals attempt to cross the multiple lanes of Bizzell Street which sees heavy vehicular use to transit across campus. The polo fields and rugby course see limited use and may be better accommodated with other recreation fields on West Campus or in a reinvented Hensel Park. However, elements such as the Bonfire Memorial are iconic and in this case a sacrosanct element of the campus and the area. Its location and configuration required considerable care in respecting this part of the Texas A&M story.

The 'build-to' line from prior planning efforts established a symbolic line running from University Drive to George Bush Drive aligned with the front of the Jack K. Williams Administration Building so that it would not have buildings constructed to the east of it. This line has been adjusted over time, and even ignored with the construction of the Emerging Technologies Building. The conflict implies that the 'build-to' line is no longer applicable – at least in its current configuration.

Workshop participants and the University leadership identified a boundary of which development could occur within:

- No development is to occur along Texas Avenue from the corner of University Drive to New Main Drive. The large buffer along Texas Avenue should be maintained as part of the visual identity of the campus as you approach and will balance the urban development across Texas Avenue.
- Utilize the Framework Schema and orientation of the Bonfire Memorial to designate a view corridor that respects the existing view sheds from Texas Avenue to the campus with Jack K. Williams Administration Building as the focal point. This will also serve to establish appropriate buffer zones to preserve the space around the Bonfire Memorial.
- Respect and enhance the New Main Drive axis into campus with additional landscape so that it will also provide a buffer from adjacent current or future uses.

In the boundary identified by the campus, there is opportunity to build up to 1.9M GSF of space in the Campus Front. As with the rest of the 2017 Campus Master Plan, the extension of the Open Space Network should drive any potential development. While there may not currently be a need for any development in this area, it is evident with what has occurred in the past that consideration needs to be given to future of the Campus Front to understand how development in this area could support campus framework without infringing upon identity or experience. The intended use of future development in the Campus Front will be primarily academic-focused with the ground level retail and dining focused along University Drive.

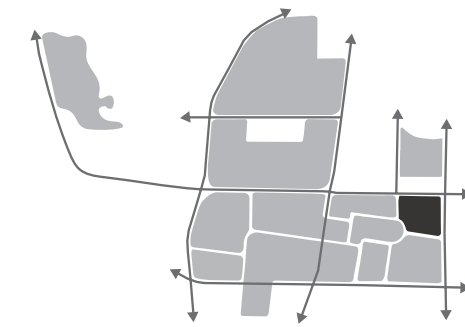

Campus Front By the Numbers:

106
Acres

305K
Existing Gross Square Feet

1.7M
New Gross Square Feet

0.07
Existing FAR

0.50
Planned FAR

2,300
Existing Parking Count

2,800
New Parking Count

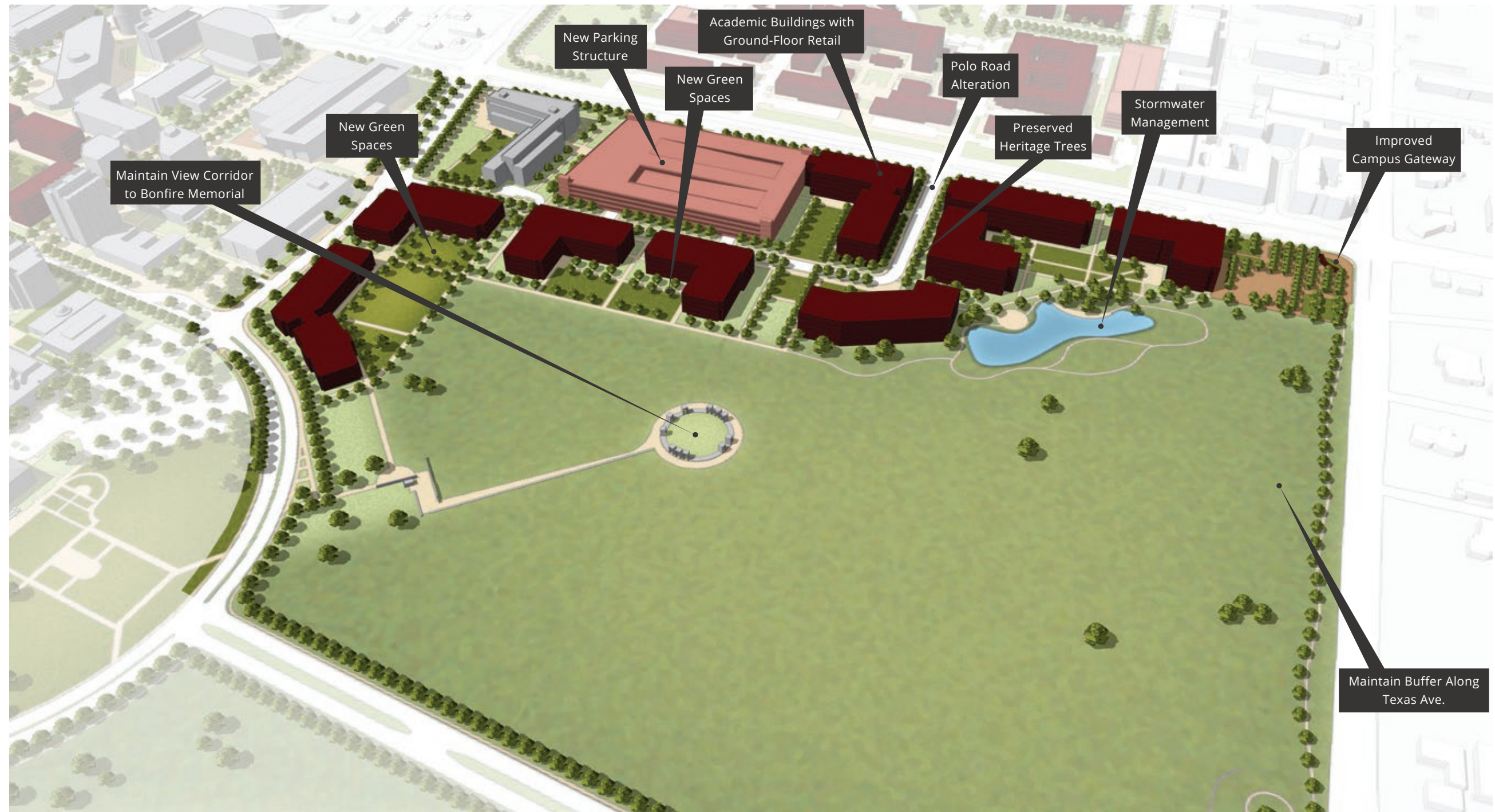

Campus Front: Proposed Scenario

The more immediate priority, taking precedence over the development of buildings and open space in this zone, is the enhancing of the condition and visual identity of the area as a major campus gateway. The corner at Texas Avenue and University Drive should be developed to strongly present the identity and character of the campus through gateway signage and landscaping. Consideration should be given to consolidating the surface parking into a structure garage near Emerging Technologies Building.

Pedestrian safety in this area is also a paramount issue to be addressed in the near-term. Presently, due to the large number of parking spaces in this zone, individuals attempt to cross the multiple lanes of Bizzell Street which sees heavy vehicular. Recent off-campus development and student housing has also created a large quantity of students crossing University Drive at Bizzell Street to access campus. This intersection lacks the appropriate pedestrian crossings and sidewalks to safely move this pedestrian traffic to and from campus. The Bryan-College Station Metropolitan Planning Organization is completing a comprehensive study that addresses University Drive. One of the desired outcomes will be to investigate possible locations for grade separations within this area.



Gateway Improvements at Texas Avenue and University Drive



Athletics and Recreation

Athletics at Texas A&M significantly contribute to the aesthetics and national prominence of Texas A&M, making the composition of this zone critical to the University's brand identity. The zone can be loosely defined as bordered by Throckmorton Street, George Bush Drive, White Creek and Kimbrough Boulevard and is physically separated by Wellborn Road and the railroad. This separation is resolved by the existing underpass at Kimbrough Road (Pickard Pass). In addition to Athletics, this zone houses Recreation Sports, Health and Kinesiology programs, the Texas A&M Foundation, the Former Students Building, and a large open space to the south of the University Center Parking Garage. What unites these programs into one zone is their large scale - The zone consists of athletics venues and expansive green spaces. At over 350 acres, this the largest of the character zones on the main campus. Its targeted density is lower compared to other zones due to the large areas of athletics and recreation fields and parks, important uses that do not impact FAR density calculations in the same way other uses across campus do.

Organizationally, the zone aligns laterally to a strong east-west connection along Kimbrough Boulevard. Strong north-south connections also exist along the roadways in the zone. Similar to the Southside, enhancing these north-south linkages through enhanced connectivity and landscape will serve to tie the campus together from University Drive to George Bush Drive. With the new development in the Athletics area, a secondary framework line forms along Tom Chandler Road to serves as a strong internal connection within the precinct.

Recent projects in the zone include the 115,000 GSF Physical Education Activity Program Building (2013), a 19,000 GSF Player Development Center (2014), and a \$450M reconstruction of Kyle Field (2015) to be the largest football stadium both in Texas and the Southeastern Conference. A new Health and Kinesiology buildings is currently under construction. In addition, new softball and track and field stadiums for Texas A&M Athletics are currently in the design phase and are planned to be opened in 2018.



Reed Arena Development

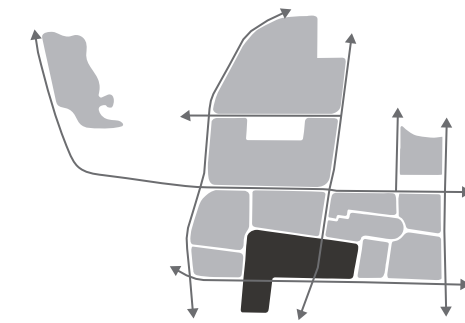

Athletics & Recreation By the Numbers:

367

Acres

2.40M

Existing Gross Square Feet

1.36M

New Gross Square Feet

0.15

Existing FAR

0.25

Planned FAR

7,400

Existing Parking Count

8,400

New Parking Count

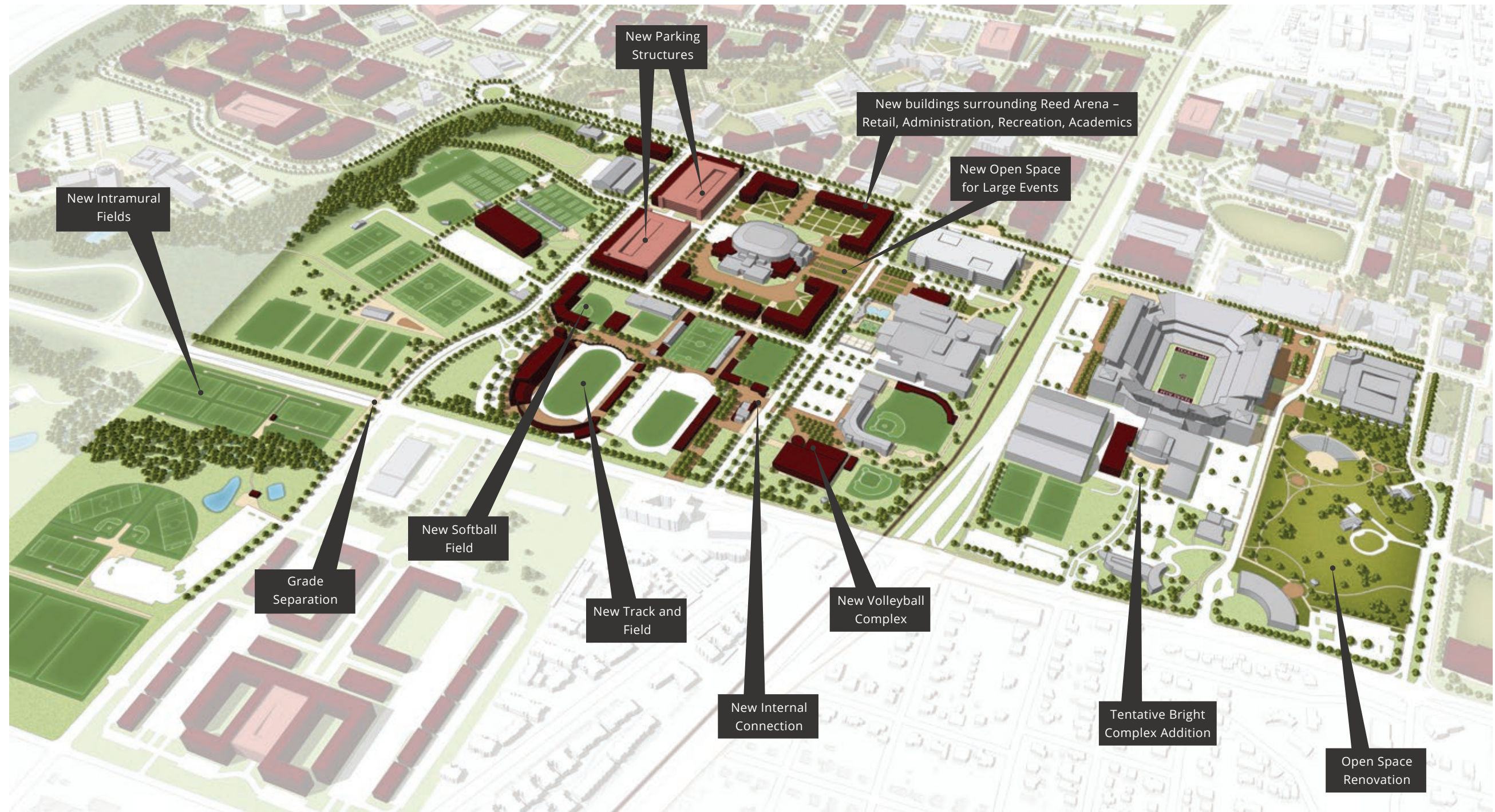

Athletics and Recreation: Proposed Scenario

Growth in the zone is aligned with the Athletics District Plan and Health and Kinesiology District Plan. Projects identified in these plans include new softball, track and field, tennis, and volleyball venues. This growth results in the relocation of several existing intramural fields to south of George Bush Drive. With the large number of students traveling to the new intramural area, the connection from Penberthy Road across Bush Drive should be enhanced to increase the safety for pedestrians and bicyclists with a grade separation. Preliminary studies exploring this grade separation reveal that space exists to create an ADA accessible pedestrian bridge over George Bush Drive. Design for this pedestrian bridge would provide an opportunity to create an aesthetic gateway to campus along Bush Drive with institutional branding, welcoming visitors to Texas A&M University. Further study is required.

The large athletics venues in the zone create parking demand that forces the campus to increase its parking ratio nearby to support large events. Currently, Reed Arena is surrounded by over 2,600 parking spaces located in seven surface parking lots. This surface lot area equates to over 30 acres. This large land area is a major opportunity in the long-term to develop up to 1.4M GSF of administration, retail, and dining space and to provide an increase in parking through two proposed structures. The planned buildings lining the existing parking lots will form new internal green spaces that will be ideal for large events and tailgating.

In order to increase safety on campus, road alterations will reduce roadways in order to accommodate separated bicycle lanes. Travel lanes and medians along Kimbrough and Olsen Boulevards are both lessened to accommodate new multi-use paths and buffered bike lanes. A multi-use path is added to the east side of Wellborn Road to improve connectivity from George Bush Drive.

The large open space south of the University Center Parking Garage, comprising approximately 2-acres, provides a significant component to the Open Space Network and is the primary park space on the east campus.

Located within the Athletics and Recreations Character Zone and immediately adjacent to the Southside Character Zone, its location also serves to frame one of the primary entry points into campus for visitors seeking to park at the University Center Parking Garage and is a frequent destination for guests on campus visiting the Williams Alumni Center.

This location, and designation as a park setting per the Landscape Program (refer to Chapter 06 for further details), supports a variety of uses and elements within the open space. Current daily uses include items such as physical training (PT) by the Corps of Cadets, classes for Health and Kinesiology, and photo opportunities at the Aggie Ring sculpture by the Williams Alumni Center. The open space is also host to special events such as Game Day tailgating and graduation celebrations. The park is also a critical element in supporting the stormwater management system on campus as an area for detention.

To further support the open space activities and programs, additional amenities are needed to enhance the functional and aesthetic aspects of this park to create a level parity amongst the Open Space Network across campus. These enhancements also must be coordinated with the need for improved stormwater management as the campus develops. One significant addition to this park is an open-air amphitheater to support large formal and informal gatherings. Inclusion of seating areas, shade, connected pathways, and general improvement to the existing landscape will improve the use and look of this open space. Gateway signage at Coke Street and George Bush Drive will further reinforce the campus boundary and improve wayfinding.



West Campus

The area known as West Campus is the development of buildings located west of Wellborn Road that developed starting in the 1960's. The zones boundary is loosely defined as Wellborn Road, Kimbrough Boulevard, Raymond Stotzer Parkway, and Discovery Drive. The zone is comprised of a variety of building materials and heights including building from one to six stories. Many of the existing buildings were designed to be program-driven, resulting in large, odd-shaped footprints, with no clear facade or main entrance. There is also little to no corresponding green space associated with their siting.

In recent years, the campus has begun to address the issues of decentralization through the connection and development of West Campus. West Campus is beginning to become an academic, research and housing hub of the campus, just as east campus has been historically. The physical connection between the east and west portions of campus has been addressed through the construction of two grade separations along Wellborn Road and the railroad. These connections have been successful in creating a physical and psychological link between the two areas of campus. However, even with the addition of physical and visual connections, the low density, lack of usable green space, lack of services, and lack of amenities for students, faculty and staff on West Campus creates a feeling that this area of campus is still "over there". In order to truly unite east and west campus, the density, ground plane, and services must be equal on either side of the railroad.

Recent projects in the zone include the White Creek housing complex (Phase I) which added approximately 1,200 beds to the zone. As this housing complex is currently removed from many amenities needed by on-campus residents, future development within the zone should seek to provide amenities such as dining, retail, and student support spaces. In 2011 construction began on the Agriculture and Life Sciences Complex, a 350,000 GSF, complex that unites many of the Agriculture and Life Sciences programs into one central location. In addition to these buildings, The Gardens at Texas A&M project will bring a 40-acre public teaching garden and greenway to campus focused on

expanding the University's research and outreach. This project will include a Teaching Gardens Complex, an Event Lawn, and Pavilion, and will aid in the restoration of White Creek.

A guiding principle of the Campus Master Plan is to use the Open Space Network as a basis for new development. New buildings in West Campus should be shaped by a network of open spaces and linkages that align with the framework extension from east campus. Planned development is focused on re-organizing the zone to become more formal in its orientation by removing the circuitous pathways that currently exist and adding in new linear malls and quads. Equally important will be the intuitive orientation of new and renovated building entrances off of main pedestrian corridors, working to create a clear organization.

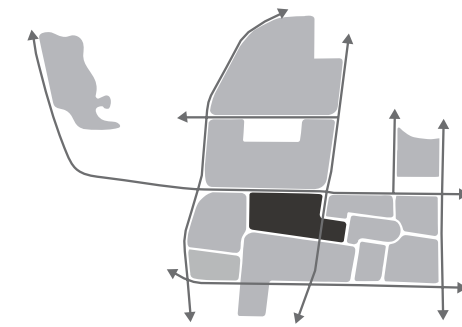

West Campus By the Numbers:

247

Acres

1.98M

Existing Gross Square Feet

4.8M

New Gross Square Feet

0.18

Existing FAR

0.75

Planned FAR

4,900

Existing Parking Count

3,000

New Parking Count

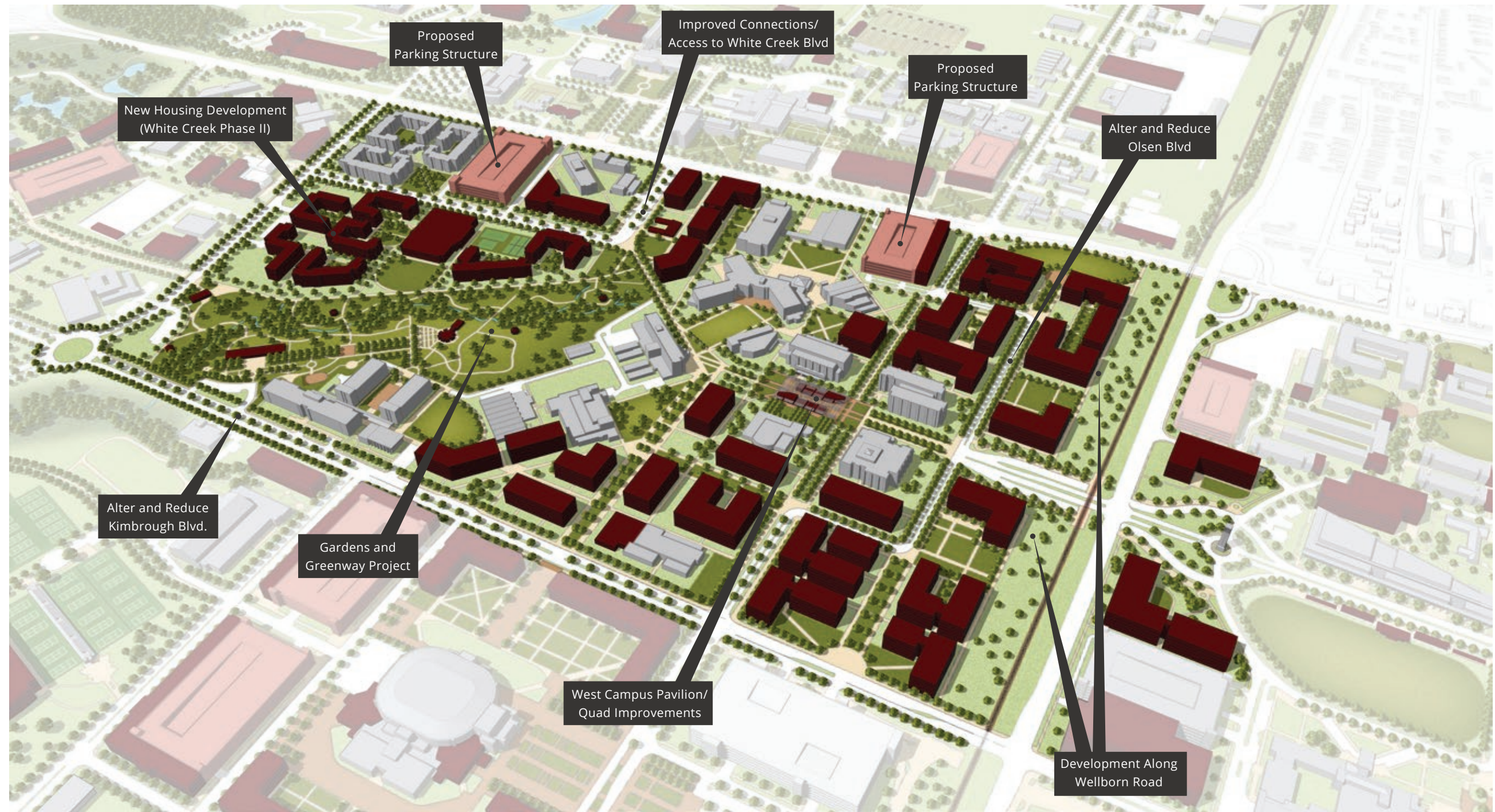

West Campus: Proposed Scenario

The West Campus “Quadrangle” is a large open space between several suburban-styled buildings. The space is currently too big and comprised of informal and circuitous pathways that do not relate to the buildings. The lack of formal organization results in unused space and confusing orientations. A new Pavilion building attempts to create a new framework that transforms an unstructured, underutilized quadrangle into the center of activity on campus. Its placement in the center of the quad creates a visual terminus along the primary campus axis and abbreviates the perceptual distance between east and west campus. The central location creates more intimate outdoor spaces that reduce the vastness of the quad. The transient nature of the building allows for the continuation of the natural flow from east to west.

Over the next 15+ years, the capacity for growth on West Campus is up to 7.8M GSF. This growth will happen incrementally starting along Wellborn Road to help to reduce the perceptual and physical distance between the east and west portions of campus.

The Phase II of the White Creek Apartment complex will add approximately 840K GSF of space (2,000 beds). This new development located adjacent to The Gardens project will create a critical mass of on-campus residents to the zone. With this substantial amount of growth, an addition to the existing SUP-1 will be required.

A major driver of the is to focus mobility planning on the pedestrian. On West Campus, the roadways are currently oversized for on-campus roads. The calls to reduce the size of roads to better accommodate bikes and pedestrians through bike lanes and multi-use paths. Major roadway alternation include:

- Reduce Kimbrough Boulevard to accommodate multi-use paths on either side
- Reduce and relocate (jog) Olsen Boulevard to better serve the dense interior to West Campus
- Addition of multi-use path on east side of Wellborn Road

- Improved connection from White Creek Boulevard to Adriance Lab Road
- With the exception of dedicated service spaces, virtually all surface parking is planned to eventually move to periphery structured parking. This allows for a more pedestrian oriented campus with more green and open space. While there are two parking garages planned to be within the zone, these do not relocate all of the parking spaces within the existing surface lots removed from the zone. Because the development plan attempts to keep the academic centers of campus dense and pedestrian oriented, additional parking garages were placed in adjacent zones (Reed Arena and Research Park). All of West Campus can be accessed within a 5 minute walk from seven parking garages. See parking diagram on page xx in Chapter 4.



West Campus Quadrangle and Pavilion



Research Park

Research Park occupies the westernmost portion of campus. It is bounded on the east by Discovery Drive and to the west by Harvey Mitchell Parkway. The northern gateway from Stotzer Parkway is the primary entrance into the zone. Starting at that gateway, Research Parkway runs south to the George Bush Presidential Library, then swings northeast to connect to Kimbrough Boulevard. Seven buildings comprise the existing Research Park facilities and include a mix of laboratory and research-oriented office buildings that include construction dates ranging from 1986 (International Ocean Discovery Building) to 2015 (Giesecke Engineering Research Building.) Building exteriors are primarily buff brick with precast detailing with building heights between two and three stories. Some of the laboratory buildings include high bay spaces. Currently, each facility has its own surface parking lot.

Key features of this zone include the duck pond and its surrounding parkscape adjacent to Harvey Mitchell Parkway, and the 20-acre grass parking area used for tailgating and large vehicle parking during game days and other major campus events. Due to the high number of broad undeveloped grassy fields and the fact that existing development has been largely uncoordinated, Research Park contains multiple interstitial areas that present opportunities for infill.

The University recognizes the need to approach future growth in this zone with a guiding organization to avoid future problems and lost opportunities that stem from uncoordinated development. The Campus Development Plan presents a concept that brings organization, promotes higher and more efficient density, and integrates this zone effectively with the broader campus.



Strong pedestrian linkages will connect Research Park to adjacent zones and create an organizing framework within the precinct for future development

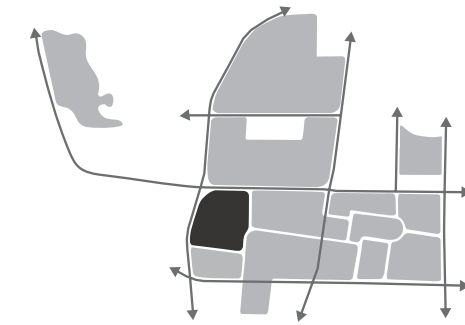

Research Park By the Numbers:

214
Acres

640K
Existing Gross Square Feet

4.5M
New Gross Square Feet

0.07
Existing FAR

0.5
Planned FAR

3,200
Existing Parking Count

6,000
New Parking Count

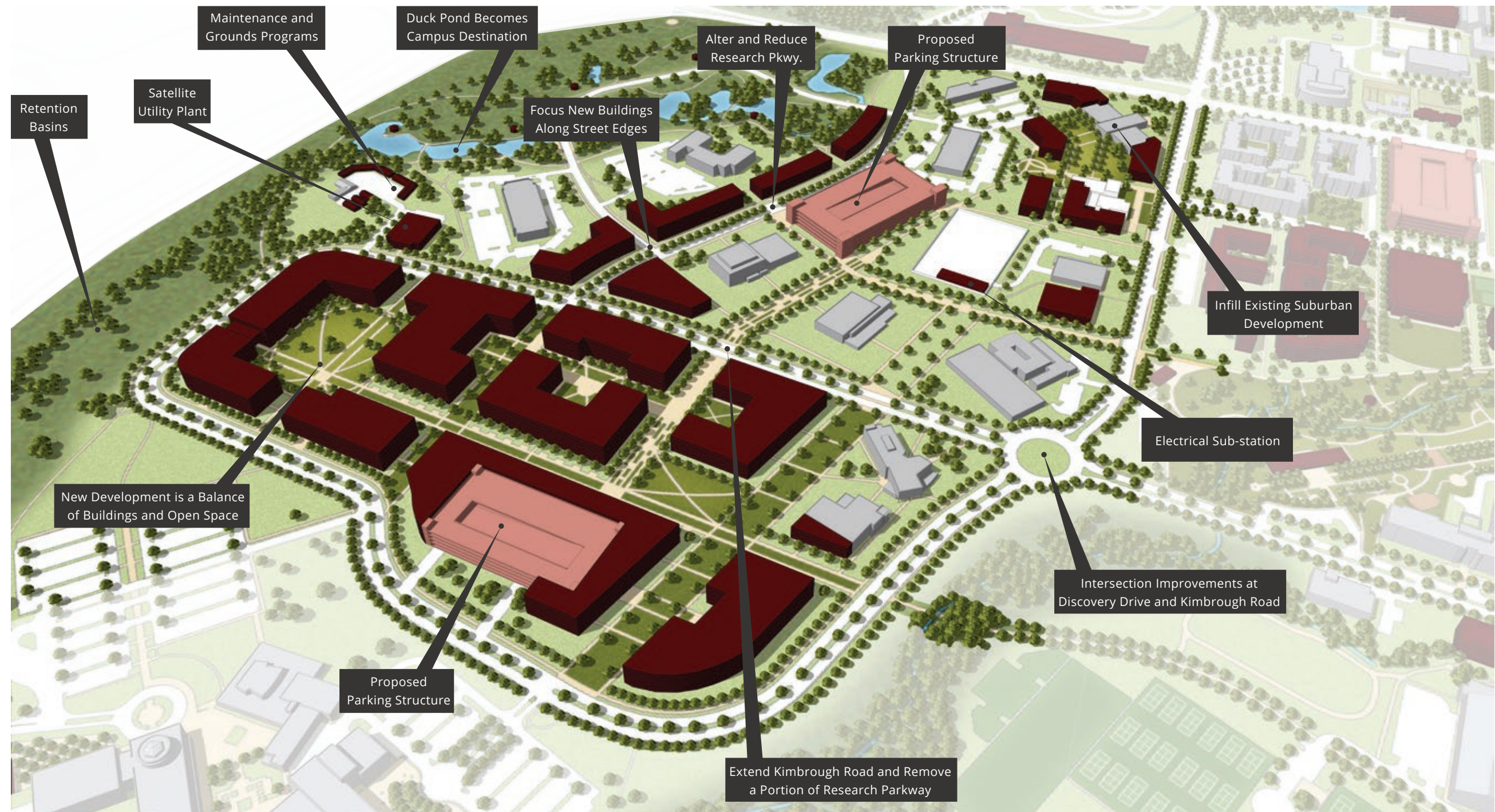

Research Park: Proposed Scenario

Key to this organization is the realignment of Research Parkway and Kimbrough Boulevard to create a more efficient circulation scheme. This layout reclaims undeveloped space from the extensive medians toward the north end of Research Parkway for new infill sites along the road, and also extends a loop from Kimbrough Boulevard west of Research Parkway to capture and define a well-proportioned region for future development. The density and organization of this new area lend themselves to interdisciplinary research and the type of cross-community interaction seen in successful innovation districts. These districts incorporate science and technology incubators, startups, and accelerators to act as a nexus linking the academic, research, and commercial communities for mutual benefit. The buildings in this zone gather around a rich environment of open space and shaded pedestrian connectors to bring researchers into a shared social space that can foster interdisciplinary interaction and innovation.

Pedestrian malls and paths establish strong north-south axes to unify this zone and integrate with east west paths linking to White Creek Boulevard, Gardens and Greenways, and through the athletic zone to Reed Arena. Kimbrough Boulevard becomes a vehicular axis efficiently connecting Research Park to west campus. Clear indications and markings will be made where the new loop roadway intersections pedestrian malls to facilitate safe movement across roads. Easy movement through the intersection of Kimbrough Boulevard and Discovery Drive is also facilitated by a two-lane traffic roundabout. The roundabout reduces vehicle speeds to increase pedestrian and cyclist safety.

Two parking garages are sited for convenient support for the eventual increased populations on the north and south ends of the Research Park. Increased future power needs of the energy-intensive research activities anticipated in this area are supplied by a planned substation located to the west of the Reta and Bill Haynes '46 Costal Engineering Lab, and by a planned utility plant southwest of 2 Research Park.



Research Park North-side Infill



Hensel Park

The Hensel Park character zone can be loosely defined as boarded by Hensel Park boundary to the north, College Avenue to the west, Texas Avenue to the east, and the new Century Square development to the south. The zone is comprised of apartment style housing for non-traditional and graduate students, a child care center, facilities and grounds buildings, and Hensel Park itself.

Hensel Park is located at the intersection of Texas A&M campus, the City of College Station, and the City of Bryan. The park has a playground, picnic pavilions, trails, and fields for open play – however, the park is underutilized and appears worn. Locationally, the park offers a unique opportunity for a campus-community connection. Planned improvements to the park include stormwater ponds to accommodate run off from new development, improved trails, recreation fields and courts, a dog park, and a new amphitheater. Realizing Hensel Park’s significant value would benefit Texas A&M University, adjacent developments, local residents, and the larger community. In order to fulfill this vision, the maintenance and grounds programs will have to be relocated to Research Park.

Outside of the park, planned growth for this zone is focused on the ability to increase capacity to expand the existing Garden Apartments, which totals approximately 270K GSF. This identified growth land area for The Gardens to be expanded to the east of the current housing development.

Another major planning driver for this zone is to improve connectivity from the main campus, and internally between the apartments, child care center, and the park. Improvements by the City of College Station to add sidewalks along College Avenue will be the first step to better connect the park to the University. Further improvements to add bike lanes and transit routes should be made to continue support for connectivity to this remote area. Internal connections from the park to the child care center and housing will create new access points into the park. Improving access to the park will ultimately increase its use by students, faculty, staff, visitors and community members making it an excellent shared amenity.



Hensel Park: Proposed Scenario

Hensel Park By the Numbers	
134 Acres	0.08 Existing FAR
458K Existing Gross Square Feet	0.5 Planned FAR
625K New Gross Square Feet	830 Existing Parking Count
	830 New Parking Count

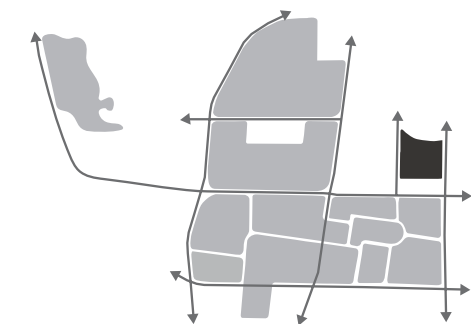

University Drive and Agronomy Road

This zone can be loosely defined as bounded by Raymond Stotzer Parkway, Harvey Mitchell Parkway, F&B Road and Agronomy Road. The area is primarily used for academics and service functions, including those related to the College of Veterinary Medicine and Biomedical Sciences (CVMBBS), as well as the General Services Building. This area can be defined as rural, however it also has an urban edge along Stotzer Parkway. The College of Veterinary Medicine Biomedical Sciences has recently completed a new 309,000 GSF building which will house state-of-the-art classrooms and teaching laboratory spaces that will enhance the learning environment for students. Combined with the expansion of the small animal hospital, the new facilities in the zone will provide opportunities for innovative teaching and will nurture collaboration and creativity. With the creation of these new buildings and others planned in the CVMBBS district plan, the existing CVMBBS buildings will be demolished to make way for higher density buildings along Stotzer Parkway including a parking garage to replace spaces lost from the surface lots that are developed.

The area to the north of the urban edge is dedicated research and teaching space for CVMBBS that primarily holds animals and sheds. These areas are not considered to be available for future buildings.

In addition to CVMBBS, there are many infill opportunities along the east side of Agronomy Road for service functions. In order to better connect this zone to main campus, Agronomy Road alterations will reduce the travel lanes to accommodate a new multi-use path from running from Stotzer Parkway to F&B Road.

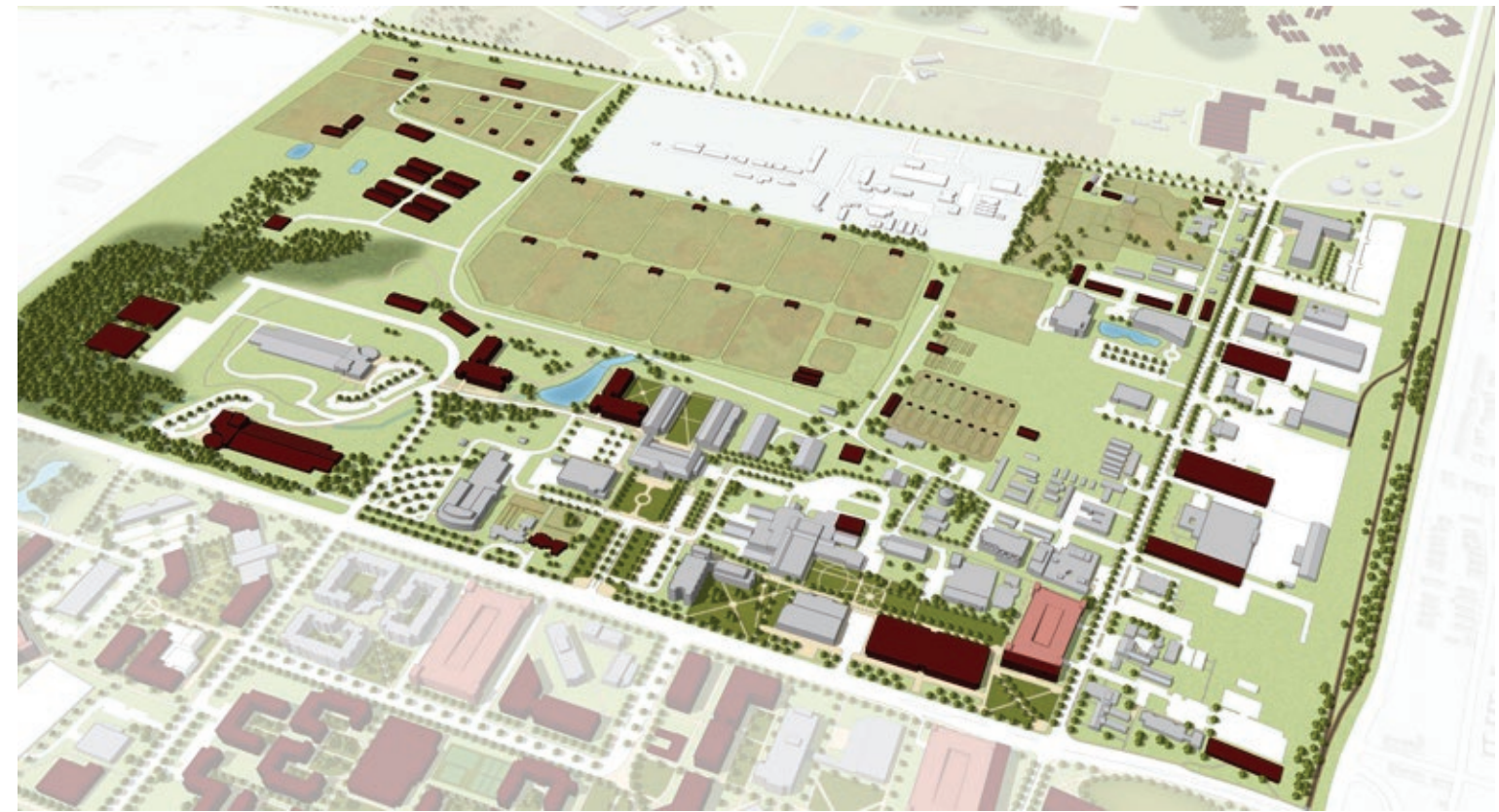

University Drive and Agronomy Road: Proposed Scenario

University/Agronomy By the Numbers	
577 Acres	0.09 Existing FAR
2.2M Existing Gross Square Feet	0.15 Planned FAR
1.0M New Gross Square Feet	1,600 Existing Parking Count
	1,600 New Parking Count

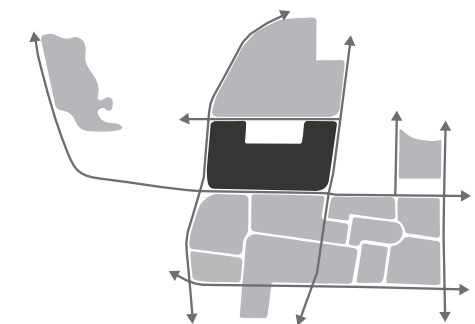

F & B Road

The F & B Road zone lies to the north of F and B Road. It is characterized by a mixture of agricultural facilities, pastures, research plots, and extensive wooded areas. Phase One of the University's Equine Initiative is housed in the zone, and a second phase is expected to be located east of Phase One. Construction has also recently been completed on the Scott's Miracle-Grow Lawn and Garden Research Center. This zone includes a parcel west of Harvey Mitchell Parkway that houses the Equine Center Stable and Freeman Arena. All together, the areas in this zone comprise over 650 acres.

The 2017 Campus Master Plan follows the recommendations of the University's Agricultural and Environmental Life Sciences Center (AELSC) Master plan regarding this portion of campus. The AELSC Master plan divides this zone into the equine facilities in the southwest area, research plots belonging to the Scott's Miracle-Grow facility along F & B Road, and an extensive area of greenhouses and field labs to the east. The existing wooded area borders these facilities on the north. At the far northern end of the property are research plots for horticulture, fruit trees, vegetables, and ornamentals. One alteration to this master plan is the Equine Initiative Phase Two, mentioned above, which will replace research facilities and fields located there in the master plan.



F&B Road: Proposed Scenario



Master Development Plan for the Texas A&M Equine Initiative, Gralla Equine Architects - 2011

F&B Road By the Numbers	
653 Acres	0.005 Existing FAR
156K Existing Gross Square Feet	0.010 Planned FAR
630K New Gross Square Feet	4,000 Existing Parking Count
	6,000 New Parking Count

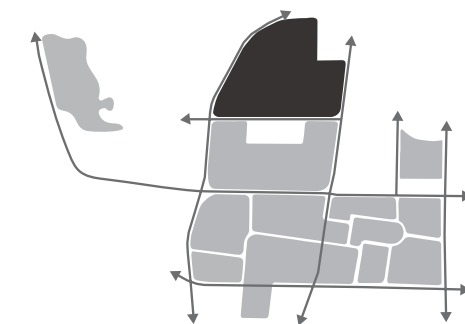

Health Science Center

The Health Science Center (HSC) is located on a 203-acre site within the Bryan city limits, about seven miles northwest of the College Station campus on Texas Route 47. It houses the University’s Colleges of Medicine and Nursing in three large academic buildings abutted by large surface parking lots. The remainder of the property is wooded and currently undeveloped, forming a buffer between the university facilities and residential neighborhoods to the east. As with the F & B Road zone, the 2017 Campus Master Plan defers to previous district-level planning undertaken by the University for the Health Science Center zone. This document, the 2008 Health Science Center Campus Master Plan and Design Guidelines, will remain the guiding document for the Health Science Center.

The HSC Master Plan calls for phased development of the site through 2030. At build-out, facilities will include a 500-bed teaching hospital, medical office buildings, research facilities, and academic community support facilities such as faculty offices, student center, and a small amount of student housing. The site will be supported by several parking garages and surface parking lots. In all, these facilities will encompass over 4 million gross square feet.



Northside: Proposed Scenario



Health Sciences Campus Master Plan, FKP Architects Inc. - 2008

Health Science Campus By the Numbers	
257 Acres	0.04 Existing FAR
465K Existing Gross Square Feet	0.35 Planned FAR
3.7M New Gross Square Feet	1,125 Existing Parking Count
	4,245 New Parking Count

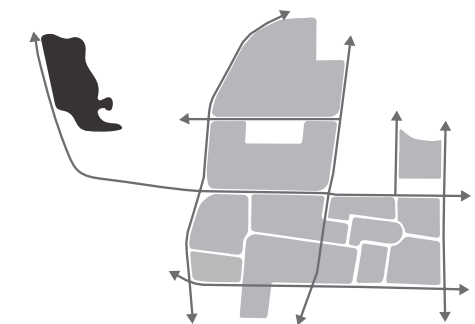

Campus Entry and Golf Course

This area is not targeted for significant development within the planning horizon of this plan. However, the Campus Development Plan presents a suggested scheme for initial expansion into this area that includes development for recreation, academic, dining, and services.



Campus Entry and Golf Course: Proposed Scenario



Campus Entry and Golf Course

Golf Course By the Numbers	
0.002	Existing FAR
171	Planned FAR
17K	Existing Parking Count
278K	New Parking Count
Acres	
Existing Gross Square Feet	
New Gross Square Feet	

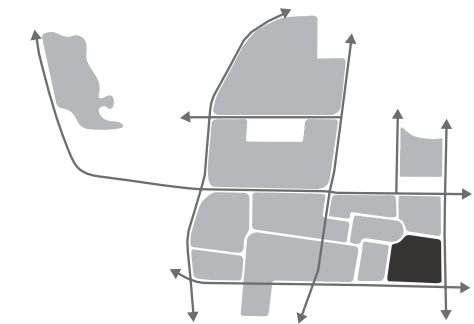

Bush Library

The Bush Library zone is home to the George Bush Presidential Library and Museum, and is managed by the George Bush Presidential Library Foundation. This area has been factored into planning elements such as circulation, dining, and stormwater management. Future development proposed within the 2017 Campus Master Plan is limited to a single new structure that will house George H.W. Bush's Marine One helicopter and a dining facility.

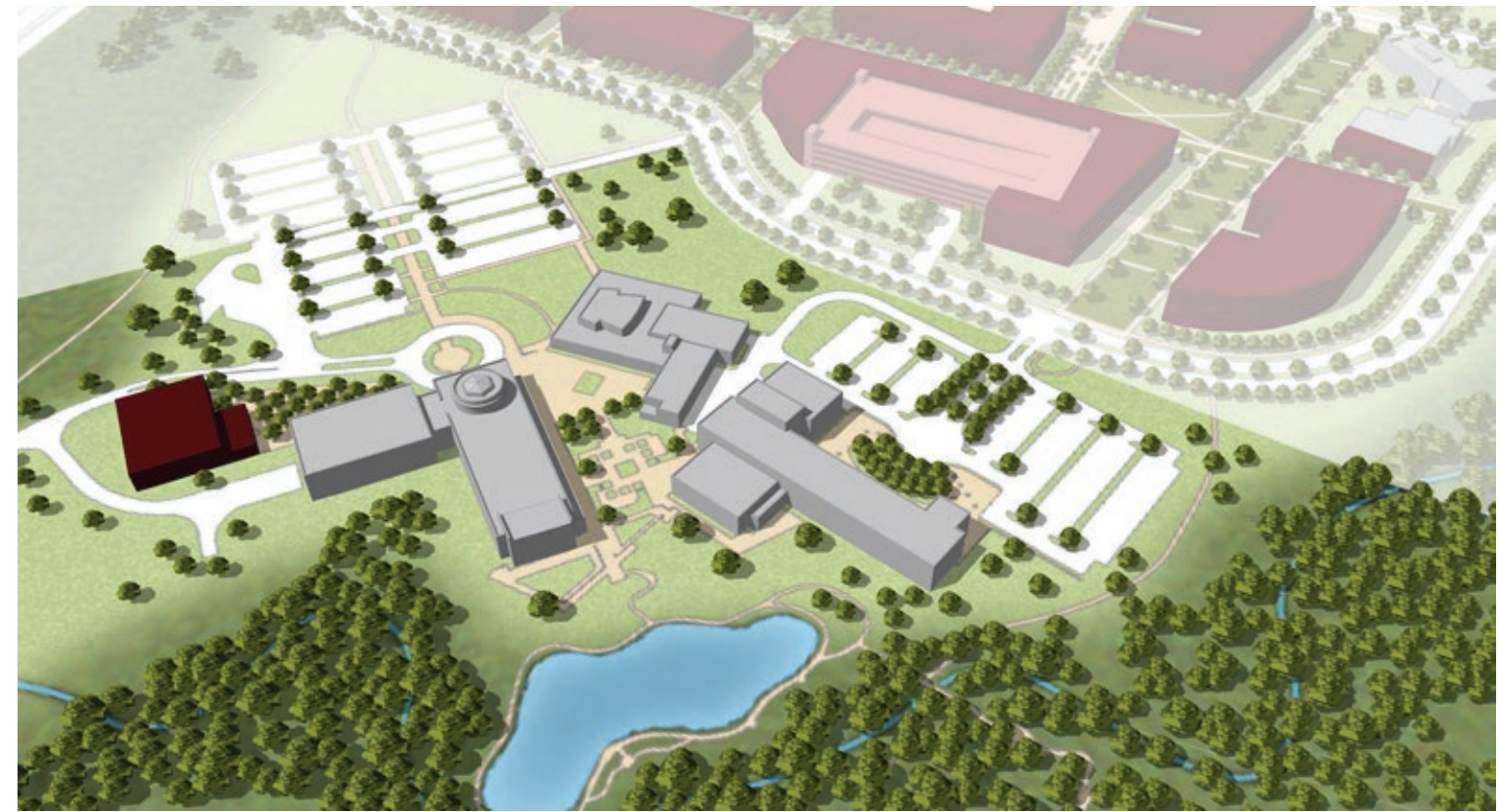

Bush Library: Proposed Scenario



Bush Library

Bush Library By the Numbers	
94 Acres	0.08 Existing FAR
320K Existing Gross Square Feet	0.08 Planned FAR
20k New Gross Square Feet	550 Existing Parking Count
	550 New Parking Count

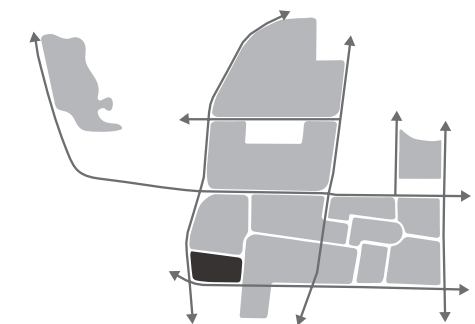

Character Zone	Acres	Land Area	Existing GSF	Existing FAR	Target FAR	ACTUAL	GSF Demolished	NEW GSF	Actual FAR	Existing Parking	Planned Parking	% Difference
Northside	98	4,268,880.00	3,618,200	0.848	1.00	691,000	248,600	4,060,600	0.95	3,532	3,882	9%
Historic Core	95	4,138,200.00	3,769,257	0.911	1.00	1,084,250	347,410	5,144,412	0.88	3,265	2,651	-23%
Southside	80	3,484,800.00	1,694,375	0.486	1.00	1,070,400	77,914	2,686,861	0.77	3,398	3,570	5%
Campus Front	106	4,617,360.00	305,316	0.066	0.50	1,653,750	-	1,959,066	0.42	2,262	2,854	21%
Athletics and Recreation	367	15,986,520.00	2,404,750	0.150	0.25	1,360,500	19,239	3,746,011	0.23	7,351	8,426	13%
West Campus	247	10,759,320.00	1,978,218	0.184	0.75	4,843,500	97,864	6,723,854	0.74	4,913	3,045	-61%
Research Park	214	9,321,840.00	639,966	0.069	0.50	4,534,500	-	5,174,466	0.56	3,276	6,047	46%
Hensel Park	134	5,837,040.00	457,727	0.078	0.10	625,250	73,473	1,009,504	0.17	835	835	0%
University and Agronomy	577	25,134,120.00	2,226,479	0.089	0.15	1,000,000	223,709	3,002,770	0.12	4,005	4,214	5%
F&B Road	653	28,444,680.00	155,784	0.005	0.01	630,350	0.00	786,134	0.03	414	614	33%
Health Sciences Campus	257	11,194,920.00	464,900	0.042	0.35	3,187,000	0.00	3,651,900	0.33	1,125	4,246	74%
Campus Entry and Golf Course	171	7,448,760.00	17,189	0.002	0.04	278,500	0.00	295,689	0.04	142	142	0%
Bush Library	94	4,094,640.00	320,741	0.078	0.08	20,000	-	340,741	0.08	554	554	0%
	3,093	134,731,080	18,052,902			20,959,000	1,088,209	38,562,008		35,072	41,080	15%

CDP Building Legend

- Proposed Buildings
- Proposed Parking Structures
- Existing Buildings
- Existing Parking Structures
- Partnership Buildings
- Off Campus Buildings



HOUSING

Residence Halls support the recruitment and retention of students, and promote their overall success. The residential experience should act as a competitive amenity that contributes positively to the University's brand. When residence halls encourage community-building, students create stronger long-term ties with each other and the University.

In 2007, the Office of Residence Life commissioned a Campus Student Housing Master Plan that considers the University's needs for the next few decades. This planning process focused on creating a residential life infrastructure that will appropriately respond to student demand, provide an attractive mix of unit, create building and neighborhood amenities, and accommodate the planning vision of living-learning opportunities. Since the adoption of the 2007 Housing Plan, the demand for privately owned off-campus housing has increased drastically. Because of the heavy off-campus competition, the financial model that Texas A&M uses for housing on campus has been adjusted from the original intent of the 2007 Housing Plan.

- **Existing Residence Halls:** In order to keep the pricing of on-campus housing competitive, the Office of Residence Life has determined that existing housing will no longer be demolished as stated in the 2007 plan, but instead existing facilities will be renovated and expanded on with the incorporation of student lounges.
- **New Construction:** All new on-campus housing must be part of a Public-Private Partnership. White Creek Housing is an example of this type of development. The existing three White Creek Housing buildings are phase one of a larger housing precinct plan that will be developed in the coming years.

Significant student learning takes place outside the classroom and as a result planning and design of future residential facilities focuses on creating environments that will foster connections and learning opportunities for students. Residence Halls and Apartments should contribute to the Live-Learn Environments established in the 2007 Housing Plan, but also look to create mixed-use programs including dining, retail, and student support spaces such as: informal studying and gathering spaces, seminar rooms, classrooms, cafes, convenience stores.

Research shows students are most likely to succeed in their academic endeavors when provided age-appropriate residential experiences that offer increased privacy and autonomy as they mature. When students first arrive to campus, making multiple connections with other students and faculty are critical to successfully transitioning into college life. Traditional-style halls, where residents must leave their room for most of their daily activities, provide opportunities to meet diverse people and foster interpersonal interactions that build relationships. As students progress and mature, having more established relationships, they need less community space and more independence in their living configuration to support continued growth. To achieve this objective, Texas A&M must develop a housing stock that consists of a mix of unit types aligned with the age profiles of the students they house on their campus.

All new housing on campus should be located within the four existing precincts: Northside, Southside, West Campus and adjacent to Hensel Park (The Gardens).



Housing Amenities: Study Spaces, Recreation Spaces, Sense of Community



Proposed On-Campus Housing

- Existing Housing
- Future Housing/Student Lounges

Northside Housing

The University has chosen to renovate existing facilities in lieu of demolishing and rebuilding. The 2017 Campus Master Plan calls to incrementally renovate each building over time, adding in student-centered lounge and support spaces not included in the original buildings. No new housing will be added to this precinct. Similar to the recent renovations at the Corps of Cadets, these new gathering spaces connect the stand alone structures, increasing the interaction between buildings and common areas. Hullabaloo Hall was recently completed and offers many improved services and amenities to the area. Many of the buildings in this zone are traditional residence halls, and therefore most appropriate for underclassmen. In order to better accommodate the residents of this precinct, a parking garage is planned to house the parking spaces relocated from displaced surface lots. Surface lot 30c will remain in place. A new northside housing quadrangle will support a variety of functions including courts and fields for recreation, smaller areas for informal studying, better connectivity through this precinct, and stormwater management techniques.

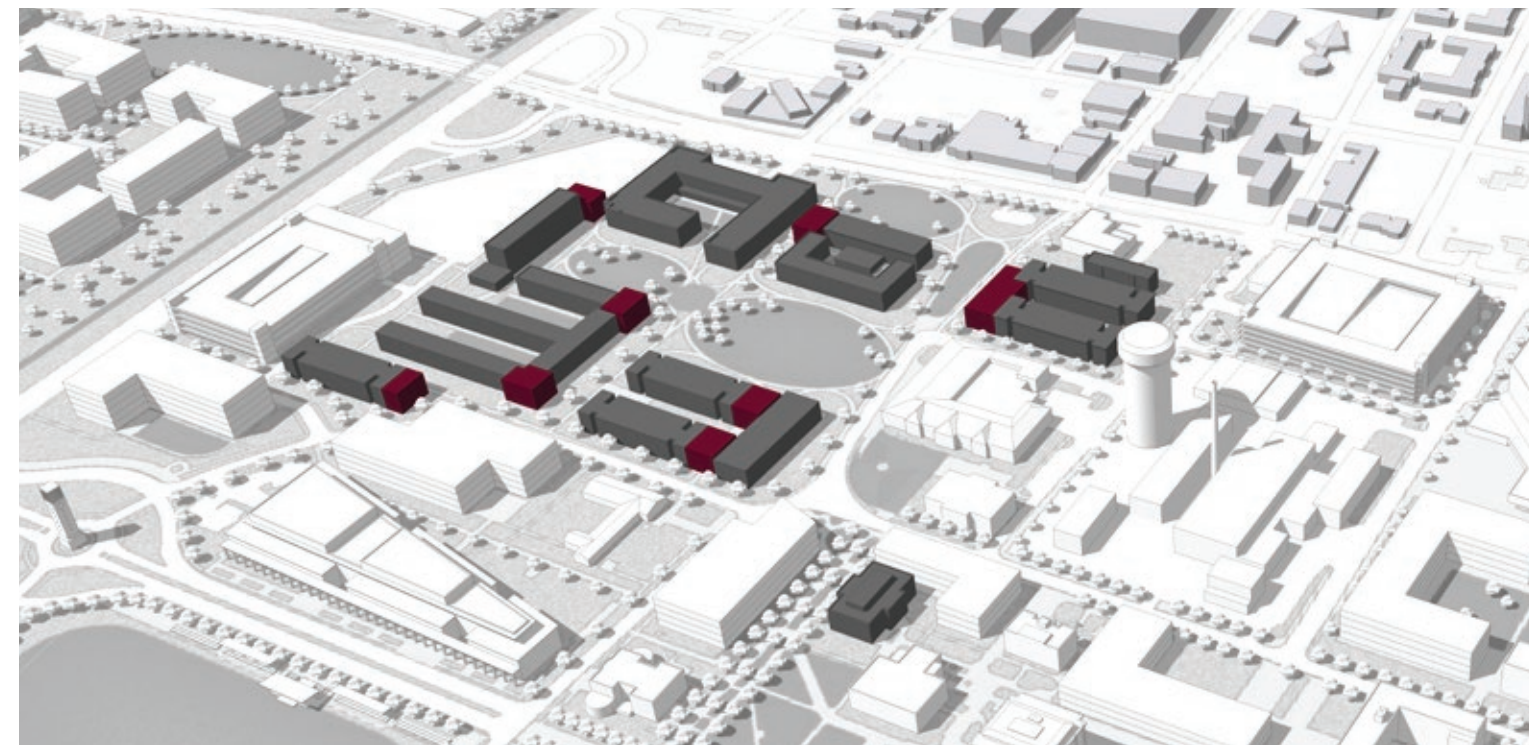

Northside Housing



Northside Housing Quadrangle

Building Name	Existing Bed Count	Existing GSF	Additional GSF	Bed Count	NEW Total
Clements	235	62,156	9,600	-	
Davis-Gary	130	40,828	13,600	-	
Fowler	250	57,696	15,200	-	
Haas	270	69,668	16,000	-	
Hobby	240	69,669		-	
Hughes	90	38,957		-	
Hullabaloo	640	254,040		-	
Kealthley	245	57,696		-	
Lechner	200	59,541		-	
Legett	155	45,134		-	
McFadden	235	62,156	16,000	-	
Moses	205	40,828	14,400	-	
Neeley	270	69,668	36,000	-	
Schuhmacher	160	38,957	17,600	-	
Walton	310	51,494		-	
	3,635	1,018,487	138,400	-	3,635

Northside Housing: Bed Counts

Southside Housing

Similar to the Northside, the University has chosen to renovate existing facilities in lieu of demolishing and rebuilding. Recently, the Corps of Cadets dormitories were renovated to add new Leadership Learning Centers and large common areas which serve not only Cadets, but the broader student population. The Commons Building was recently renovated to improve dining and student services in this area. Many of the buildings in this zone are traditional residence halls, and therefore most appropriate for underclassmen.

The vision for the Southside Housing precinct is to provide a blend of academic, innovation, and co-curricular programs integrated within the residence halls. The Plan calls to incrementally renovate the remaining buildings in this precinct over time, adding student-centered lounges, academic spaces, and an innovation center. Improvements to connectivity and outdoor spaces should occur in tangent with building renovations, such as those to Haney Drill Field and the open area in between the Corps dorms and the Commons buildings.

As the Corps of Cadets grows in enrollment, additional housing will be needed south of Lewis Street to house the Aggie Band. As additional on-campus housing is demanded long-term, the area south of Lewis offers potential for over 700K GSF of new housing (approx. 1,700 beds).



Renovation to Corps of Cadets Residence Halls and Quad

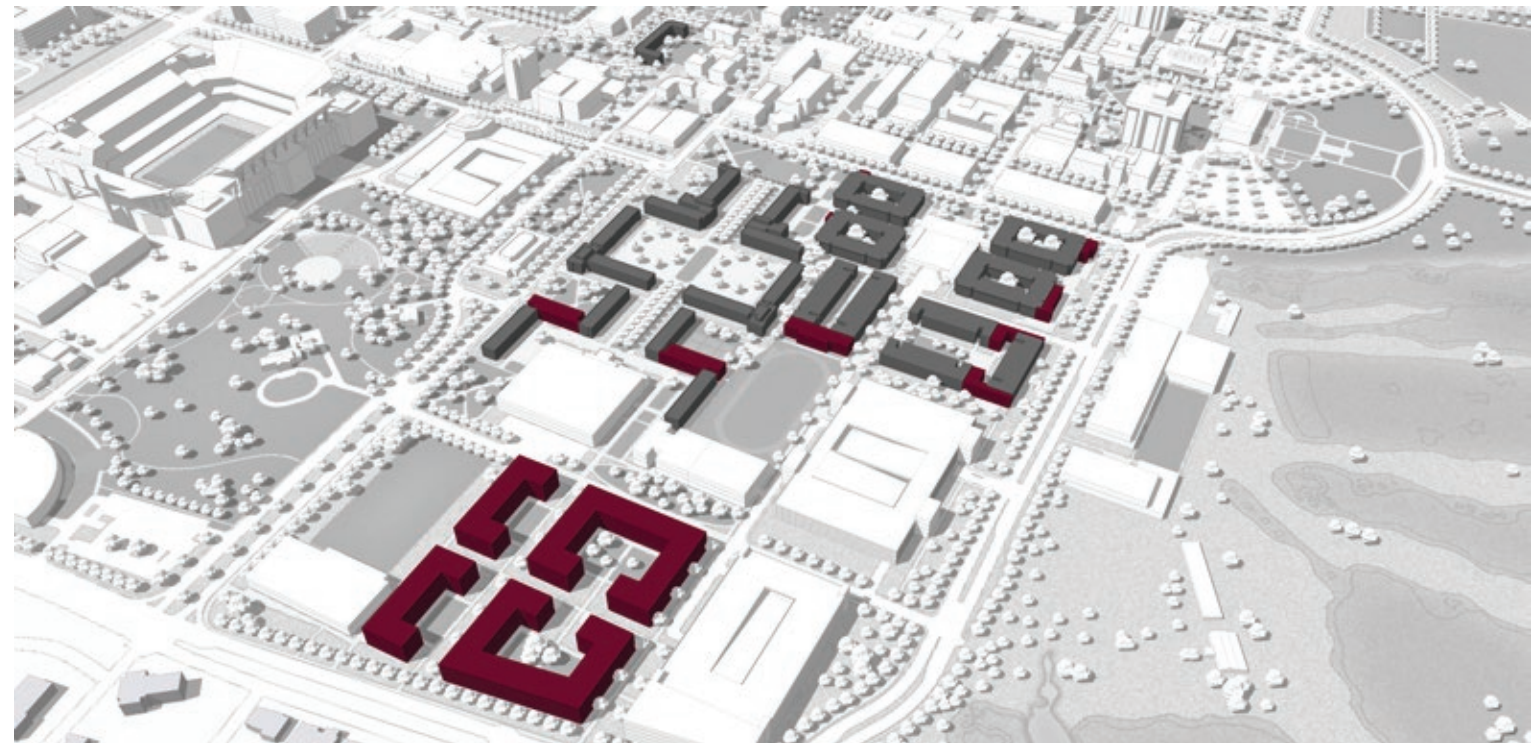

Southside Housing

Building Name	Existing Bed Count	Existing GSF	Additional GSF	Bed Count	NEW Total
Appelt	300	82,767			
Aston	460	113,388	2,400		
Dunn	460	112,133	2,400		
Epright	235	67,283			
Hart	270	50,416			
Krueger	460	112,133	2,400		
Mosher	660	155,430	2,400		
Rudder	235	67,283	34,400	-	
Underwood	300	81,730	26,000	-	
Wells	235	67,283			
Corps Dorms	2,600	428,509	66,000	80	
NEW			107,500	270	
NEW			107,500	270	
NEW			251,250	630	
NEW			238,750	600	
	6,215	1,338,355	841,400	1,850	8,065

Southside Housing: Bed Counts

Westside Housing

In alignment with the recently completed White Creek Housing project, there is additional housing planned south of West Campus Boulevard, adjacent to the new Gardens and Greenway project. This plan will add approximately 2,000 beds to the area. The new housing is planned to be residence halls.

In addition to the housing, the White Creek Community Center is planned south of West Campus Boulevard to support additional dining, retail, and student support space in the area. A future parking garage is also proposed to better accommodate the residents of this precinct and to house the parking spaces relocated from displaced surface lots.

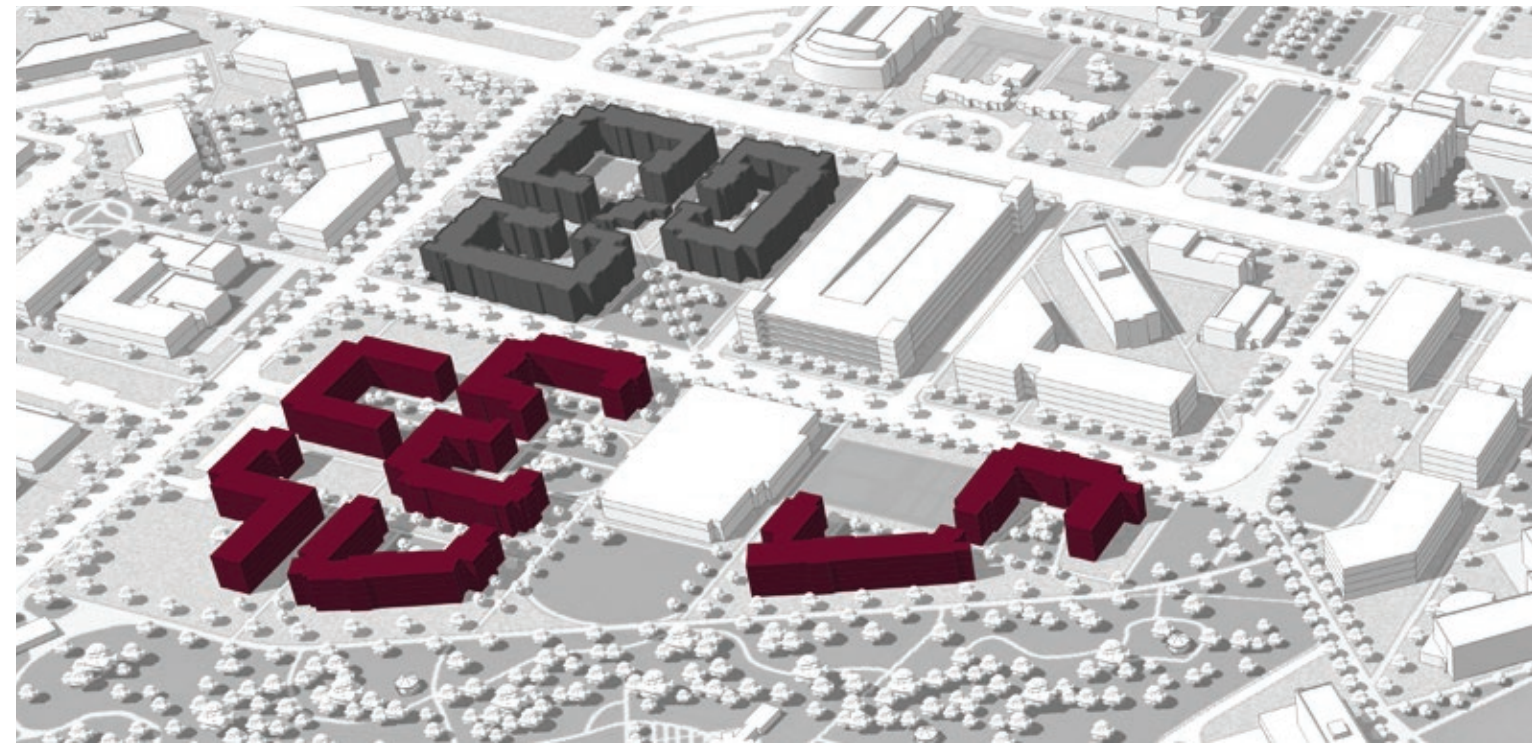

Northside Housing



West Campus Housing Precinct (professional rendering forthcoming)

Building Name	Existing Bed Count	Existing GSF	Additional GSF	Bed Count	NEW Total
White Creek A	420	176,046			
White Creek B	420	181,714			
White Creek C	420	181,681			
NEW HOUSING			123,000	300	
NEW HOUSING			113,750	280	
NEW HOUSING			111,250	280	
NEW HOUSING			122,500	300	
NEW HOUSING			123,000	300	
NEW HOUSING			125,000	300	
NEW HOUSING			120,000	300	
	1,260	539,441	838,500	2,060	3,320

West Campus Housing: Bed Counts

The Gardens

The Gardens (adjacent to Hensel Park) is housing prioritized for graduate, married, families, veterans and international students. As the non-traditional and graduate level student body grow at Texas A&M, the demand for on-campus apartment style housing will increase. The Gardens can be expanded to both the east and west of the current housing development. Improved access into an upgraded Hensel Park will create a new amenity for the residents in this precinct.

Building Name	Existing Bed Count	Existing GSF	Additional GSF	Bed Count	NEW Total
The Gardens F	42	33,535			
The Gardens G	42	33,535			
The Gardens H	42	33,535			
The Gardens J	42	33,535			
The Gardens K	42	33,535			
The Gardens L	42	33,535			
The Gardens M	42	33,535			
The Gardens N	42	33,535			
The Gardens P	42	33,535			
The Gardens Q	42	33,535			
NEW HOUSING			33,535	42	
NEW HOUSING			33,535	42	
NEW HOUSING			33,535	42	
NEW HOUSING			33,535	42	
NEW HOUSING			33,535	42	
NEW HOUSING			33,535	42	
NEW HOUSING			33,535	42	
NEW HOUSING			33,535	41	
	420	335,350	268,280	335	

The Gardens: Bed Counts

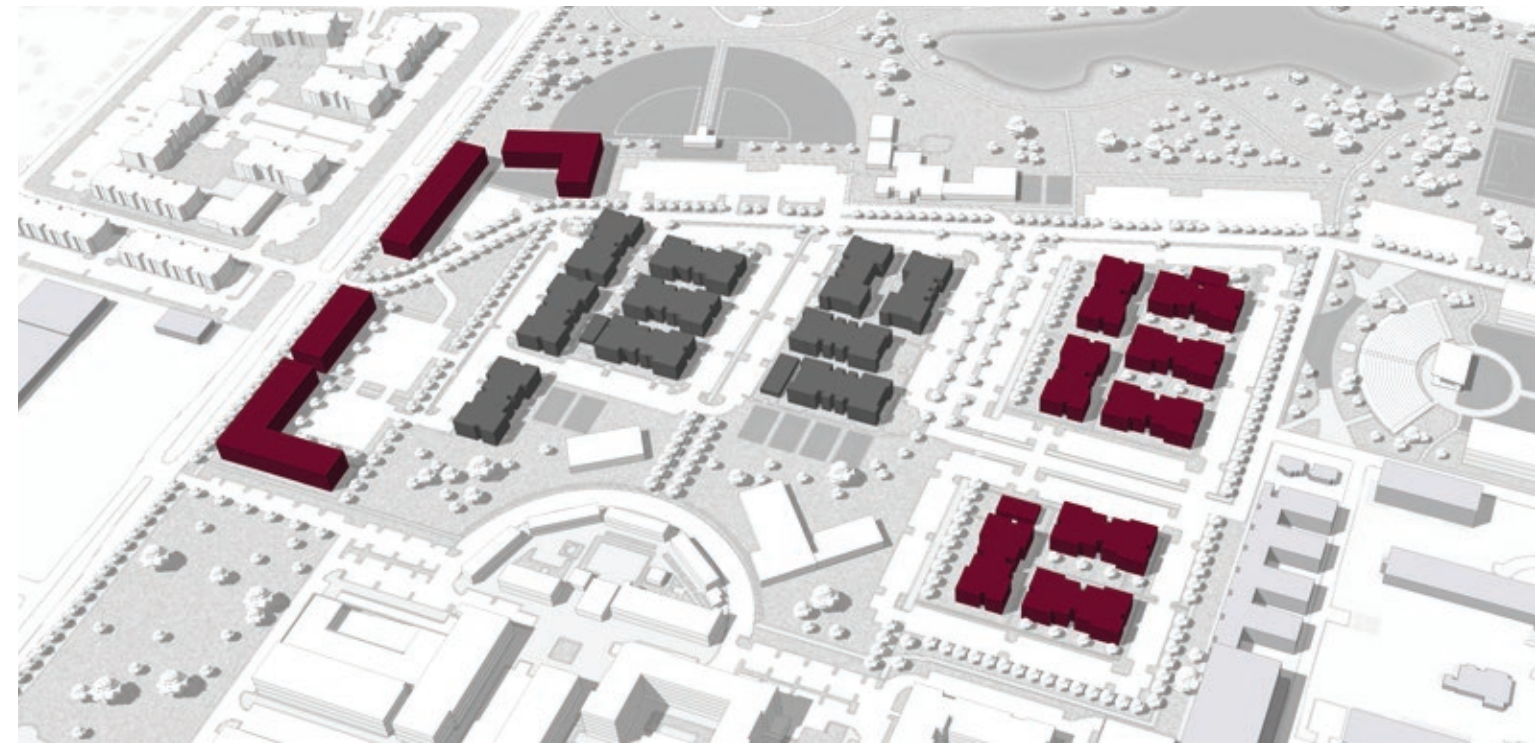

The Gardens



Caption

DINING LOCATIONS



Dining is an important social experience for campus users and provides opportunities to meet new people and interact with individuals outside ones defined academic program or residence group. Texas A&M University provides physical spaces for a third-party vendor to provide food and dining services to the campus community.

As continued development occurs, especially on West Campus, the University should plan for space to hold new dining operations within. The key to this growth is to provide a blend of full-dining services - such as food courts or buffet style venues, and smaller services such as snack bars and coffee shops.

In the interim, food trucks are a great way to serve remote or low population areas without a large investment. The creation of food truck stops with hook-ups throughout campus can allow for trucks to rotate around the campus from day-to-day. This is a good way to test demand in an area prior to investing in a physical space while populations grow in underdeveloped areas of campus.

To eliminate the food deserts on campus, locations should be planned using a ½ mile radius of to ensure that the entire campus population is being served. Currently, the largest under-served areas of campus are West Campus and Research Park. As development occurs in both academic programs and on-campus housing, the populations of these areas will increase to better support dining functions. Additional dining should simultaneously develop as new academic buildings and housing come online to ensure that the population is accommodated immediately.



Food trucks are a great way to serve remote or low populations without a large investment



Farmer's Markets can provide another type of dining on campus.

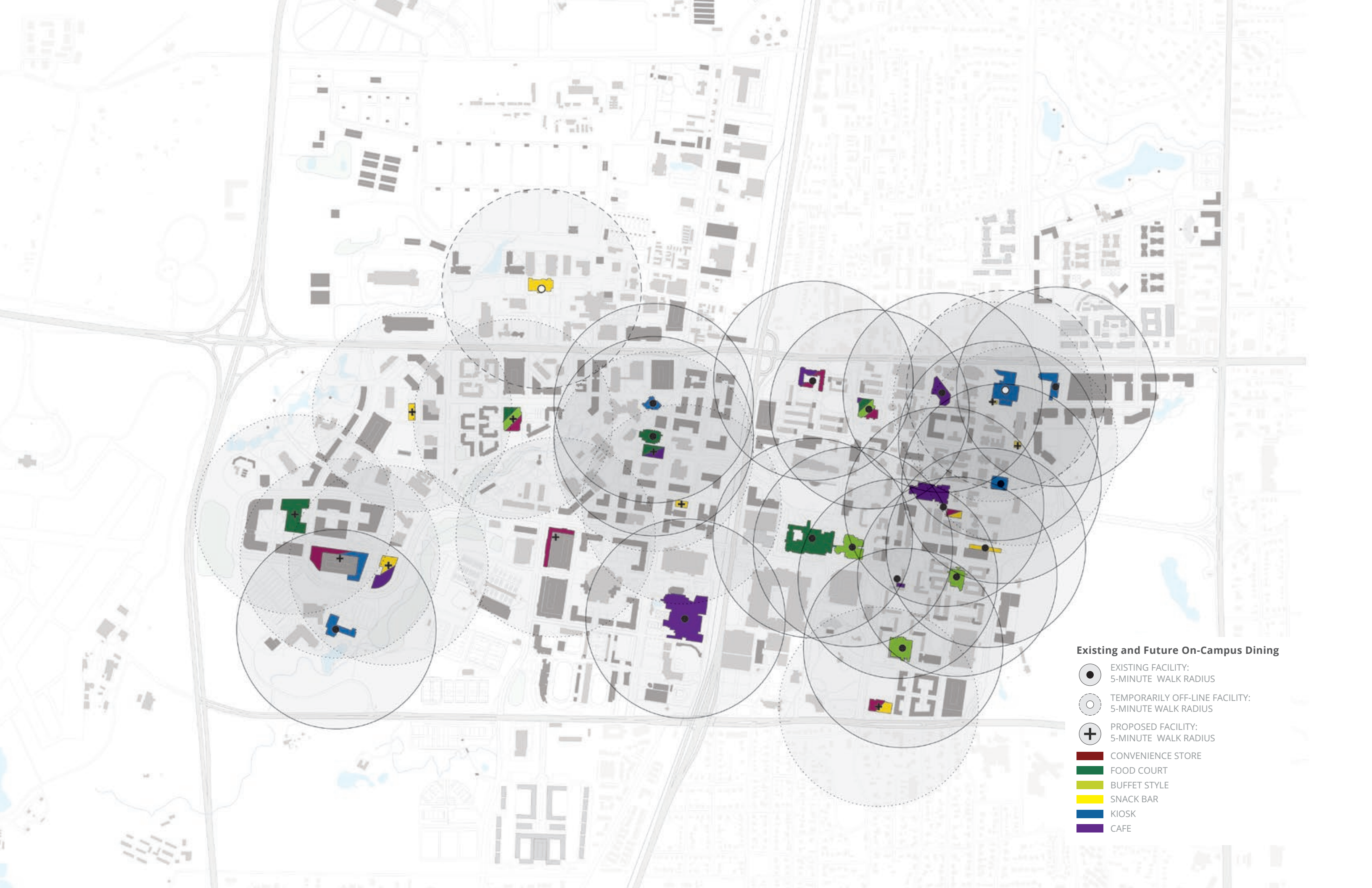

Existing and Future On-Campus Dining

- EXISTING FACILITY:
5-MINUTE WALK RADIUS
- TEMPORARILY OFF-LINE FACILITY:
5-MINUTE WALK RADIUS
- ⊕ PROPOSED FACILITY:
5-MINUTE WALK RADIUS
- CONVENIENCE STORE
- FOOD COURT
- BUFFET STYLE
- SNACK BAR
- KIOSK
- CAFE

PUBLIC ART

Texas A&M University has an extensive art collection managed by multiple departments across the university that includes a diverse array of pieces ranging from paintings, photographs, sculpture and monumental works.

The vision of the Public Art program at Texas A&M University is to expose the Texas A&M community to works of art that inspire and instill a lifelong appreciation for the value and impact of the visual arts in enhancing education, stimulating reflection, promoting cultural enrichment, attracting interest and attention, and improving the intellectual and visual environments of the University. These objectives will be achieved through the use of public art to transform sites, structures and spaces into cultural destinations.

As per the University, Public Art refers to two- or three-dimensional works of art--both in traditional media (stone, bronze, etc.), environmental media (earthworks and landscape art), as well as new media (digital, video, etc.) created or considered for installation in public spaces so long as they are not associated with the acquisition activities of the Texas A&M University Stark Galleries, Forsyth Galleries, other University galleries and collections or other curated and archived collections. Functional objects (such as benches, light fixtures, etc.), which are created as unique works of art also are included in this definition. Public spaces refers to sites exterior to buildings, unenclosed interior spaces (e.g. atria) and enclosed interior spaces such as lobbies, social spaces and other high traffic areas, with the exception of departmental spaces such as conference rooms, personal offices and other administrative areas.

The Collection

Currently, the public art program at Texas A&M University consists of mainly bronze sculptures of historical figures, monuments or memorials that commemorate a notable person or event, and pieces that seek to express community values, heighten awareness and enhance the landscape.

Moving forward, the University should seek to enrich the cultural and intellectual life of campus by building and maintaining a unique collection of public art created by leading artists of our time.

Diversifying the type of art placed on campus will better align the University with its commitment to diversity. The subject matter of the existing collection is extremely limited - with about 30% of the collection being bronze statues of historical figures. To better position Texas A&M as a global leader in higher education, there is opportunity for the University to select pieces and commission artists from diverse backgrounds to celebrate and acknowledge differing identities, values and ideas.

Locationally, the campus offers many opportunities for the placement of art. All placement of public art should align with the Framework Schema and Open Space Network introduced earlier in this chapter. Art should be placed in settings appropriate to their scale, purposes, aesthetics, and materials. This includes along or at the terminus of major malls or connectors, within campus quads, courtyards, and pocket parks and to denote important nodes or intersections of the campus.

Because these pieces typically do not exist in controlled gallery environments they are not protected from the elements, accidental damage, or building renovations. Monumental works cannot be addressed by the same trades that perform tasks associated with building maintenance, repair, or construction and must be cared for by qualified professional art conservators. Texas A&M should conduct a comprehensive survey and assessment of integral building and public art and conserve at risk integral building and public art.

All permanent public art pieces shall be identified with either a plaque or other appropriate signage as per Texas A&M Procedure for Campus Plaques.

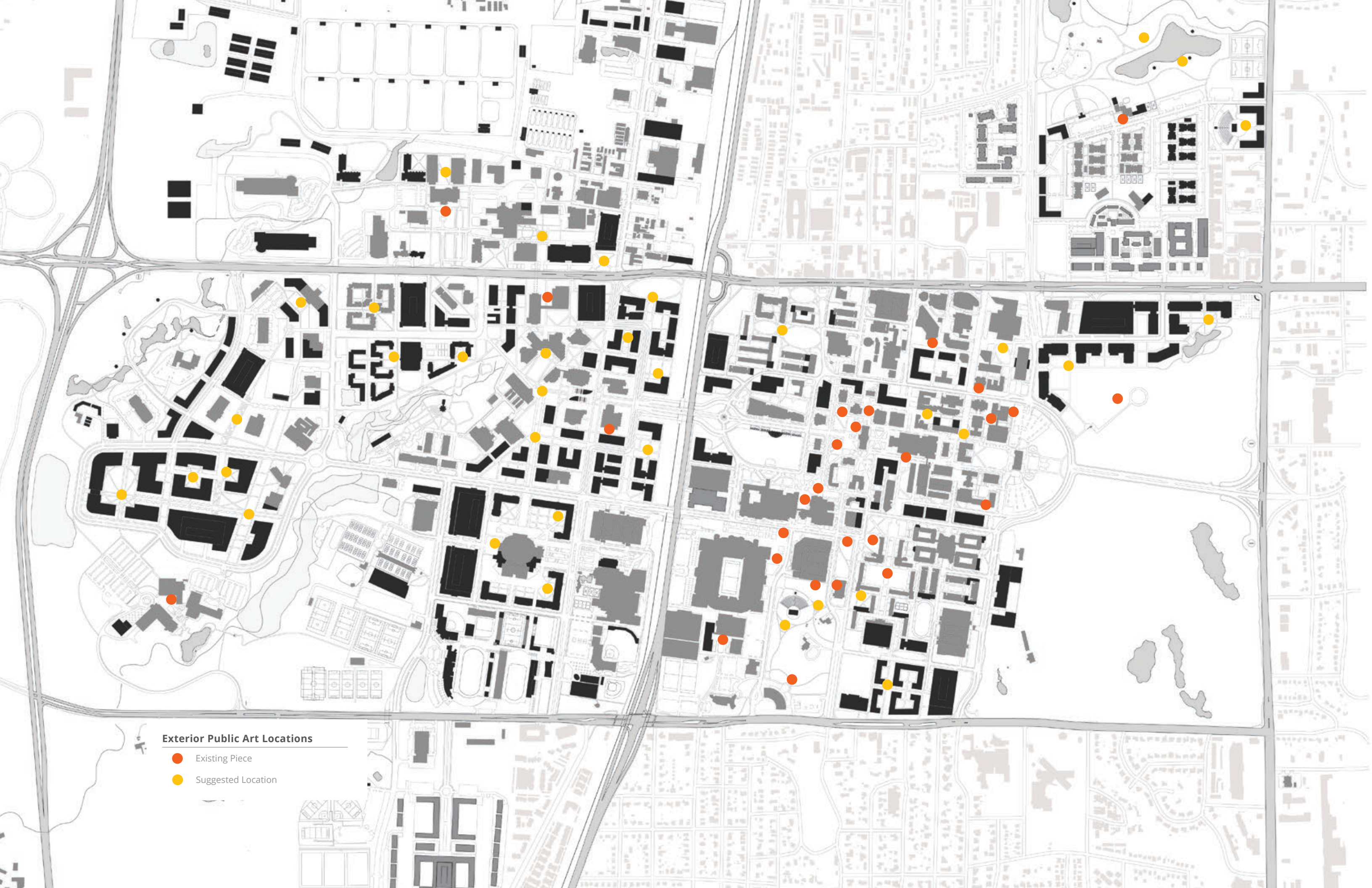

Exterior Public Art Locations

- Existing Piece
- Suggested Location

Overview of Campus Art Policies and Procedures

In July 2015, the University published its Procedures for Public Art. The following text is a summary of the procedures and policies.

The Council for the Built Environment Design Review sub-council Art Committee (DSrc Art Committee) is dedicated to 1. Overseeing the selection, installation, management and deaccessioning of works of public art that convey, reinforce and expand the University's ideals and identities, 2, Supporting the mission of the University by adding a dynamic public art presence to the Aggie experience, 3. Enhancing the aesthetic appeal of the Texas A&M University campus; and 4. Fostering the global prestige of Texas A&M University as an institution.

The committee is comprised of Design Review sub-council members, a faculty member with a terminal degree in the arts/or art history, theory and criticism, an undergraduate student representative, and a graduate student representative.

The Design Review sub-council Art Committee applies a consistent set of criteria in evaluating works of public art that are offered to the University, as well as works that the University or its units pro-actively seek to add to the public environment.

Essential to the criteria are the following:

- Artistic quality
- Appropriateness
- Feasibility
- Site context
- Durability
- Maintainability
- Safety

Preference is given to works selected through a competitive process, including: 1. Individual already-created art pieces considered for purchase. (Individual already-created art pieces offered as gifts would follow the same procedures for accepting and placing art.), 2. Art pieces commissioned based on donated funds, and 3. Art pieces commissioned as part of a capital building construction project.

For major capital construction projects, the University Architect with consultant architects and stakeholders should identify opportunities for public art to be incorporated. In accordance with Texas A&M University System policy, it is recommended that up to 1% of the construction cost of capital projects falling within the scope of this policy shall be allocated to the acquisition of artwork commissioned by the University. It is strongly recommended that an add alternate approach be utilized in the event that up to 1% is not available because of costs associated with core programmatic functions. Art shall be considered a priority when evaluating the use of contingency funds once all construction related contingency expenses have been funded. Allocated funds for proposed projects and surplus funds from completed projects will be maintained in a University-controlled account administered by the Office of the President.

Deaccessioning is a legitimate and necessary part of the formation and care of collections and, if practiced, should be done in order to refine and improve the quality and appropriateness to better serve the University's mission. As a general rule, disposal of collections objects, or deaccessioning, is permissible unless specific restrictions apply. Deaccessioning procedures are designed to insure thoughtful, well-documented consideration of each proposed disposition in the context of the long-term best interests of Texas A&M University. Artwork may be removed or deaccessioned from the public art collection at the recommendation of the DRsc Art Committee and with the final approval of the President.



Existing Public Art
From Top Left to Bottom Left:
Memorials/Monuments: Freedom
from Terrorism Memorial (2008),
Muster Arms (2000), Bonfire Memorial
(2004); Statues: Twelfth Man (1980),
The Roughneck (1991), James Earl
Rudder (1993); Public Art: Menos
(1992), Shaping the Future (1999), The
Day the Wall Cam Down (1996)



FORUMS

A **forum** is defined as a place, meeting, or medium where ideas and views on a particular issue can be exchanged.

A great research university requires a dynamic community that provides exposure to a wide range of perspectives, and generates encounters and interactions. Interaction leads to new insights and discovery. The campus should be organized to foster these interactions.

In focus group meetings, many comments from campus users revolved around using the campus to promote the exchange of ideas, or to display the academic and research work that the University is engaged in. This occurs in existing spaces such as the Memorial Student Center where students from all academic majors and classes converge to gather, eat, study, promote, learn, and celebrate. Forums attempt to create this type of energy through the campus in a network of active, lively and vibrant spaces. As development occurs, forums should be central spaces within character zones that have both indoor and outdoor functions.

New Green Spaces at Lamar Street and Nagle Street, the Northside Housing, and within Engineering Quadrangle will become central spaces of activity as development occurs around them. These new green spaces should accommodate many different programs and activities such as food trucks, a farmers market, meditation, group exercise and recreation, and outdoor studying and gathering areas.

New built spaces such as the new White Creek Community Center and a West Campus Pavilion should support both indoor and outdoor functions. Indoor functions that add to the idea of forums include galleries, incubator or maker spaces, movie cinemas, retail, and open computer labs.



Relaxing



Food Truck



Performance



Classroom



Start-Up



Research



Farmers Market



Meditation



Game Room



Cafe



Bike Repair



Outdoor Seating



Group Exercise



Movie Theater



Public Art



Reading Room



Healthy Dining



Recreation



Gathering



Retail



Services



Group Meeting Space



Computer Lab



Lecture Space



Maker Space

Forum Activities and Programs

Campus Forums

- PLANNED FORUM PROJECT - NEAR TERM
- EXISTING FORUM SPACE
- PLANNED FORUM PROJECT - LONG TERM

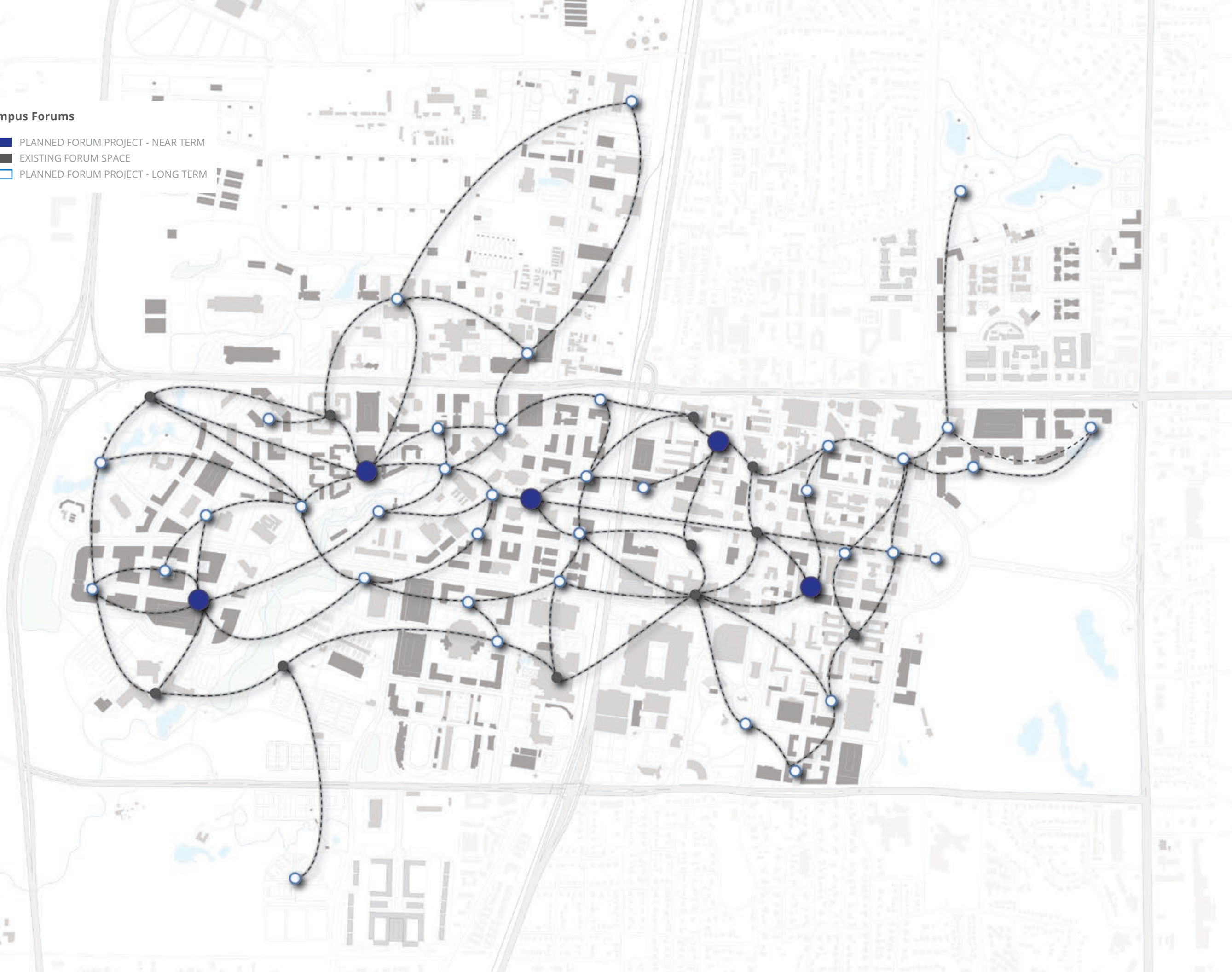

Pavilion Forum – West Campus Quadrangle

The West Campus “Quadrangle” is a large open space between several suburban-styled scattered buildings. The space is too big and comprised of informal and circuitous pathways that do not relate to the buildings. The lack of formal organization results in unused space. The West Campus Pavilion attempts to create a new framework that transforms an unstructured, underutilized quadrangle into the center of activity in this area of campus – a focal point for an indistinguishable area. Its placement in the center of the quad creates a visual terminus along a primary campus axis and abbreviates the perceptual distance between East and West Campus. The central location creates more intimate outdoor spaces that reduce the vastness of the quad. The transient nature of the building allows for the continuation of the natural flow from east to west.

The building should seek to achieve two goals: 1. Form a strong connection to the landscape, and 2. Foster social interaction within the Pavilion and the surrounding Quadrangle

The outdoor space surrounding the building should respond to the form of the pavilion and attempt to create a formal organization of the quad with rich green spaces and gathering spaces. Trees should be placed to both offer shade and create intuitive movement within the quad. Landscape should be lush and human in scale, bringing much needed softness to the overly paved space. The building itself should also offer shade and transition from indoor to outdoor space in the form of a loggia, overhang, canopy, or similar element.

The program should remain flexible, and encourage non-assigned space that is focused on creation of culture, social activity, wellness and mindfulness, and collaboration. A modular design can allow ease of future expansion as demand and growth increase on the West Campus. The interior spaces should be programmed to accommodate a variety of gatherings and scale – for individual and group studying, meetings, lectures, and performances – combined with the ability for activities to spill outside. A critical element for inclusion is dining opportunities that support wellness and interaction.



Forum Building: West Campus Pavilion



Forum Building: West Campus Pavilion



Open Space Forum – Engineering Quadrangle

The proposed Engineering Quadrangle in the Northside Character Zone will provide much needed open space in an area of campus with significant building density. In contrast to the Pavilion Forum, which is infilling under-utilized open space with built structure, the Engineering Quadrangle will remove built structures to create the second iteration of the Forums – exterior space that supports multi-programmed uses, strengthens campus connections, and creates a variety of open space scales.

The new quad will directly support three Landscape Program elements – People Movers, Large Gathering and Small Gathering programs. The People Movers are represented by an east-west link, nominally called Engineering Walk, connecting between Spence and Bizzell Street and potentially beyond. The north-south people mover links between Ross Street to Engineering Walk. The Large Gathering program is represented by the proposed oval central area between Zachary Engineering Education Center, Wisenbaker Engineering Building and the CE Office Building. The Small Gathering program is interspersed along the edge of the people movers and large gathering zone, providing buffers and alternate scales nearer to surrounding buildings.

At a finer grain, specific Forum activities and programs envisioned for the Engineering Quad include Public Art, Relaxation Areas, Gathering Zones (both large and small), Outdoor Seating for multiple uses, Food Trucks, Bike Storage/Repair, and Research Display. Selected examples of these activities include: a significant art piece intended as a focal point of the Quad; food trucks and seating located at the western end of Engineering Walk; and utilizing the Quad for display or testing of student projects and research occurring in adjacent buildings.

Strong interior and exterior connections to the adjacent buildings ground level program elements are intended to link inside and outside. Facing directly onto the quad, Zachary Engineering Education Center has student gathering and support spaces, the CE Office Building will have a student recruitment component and the Wisenbaker Engineering Building will have informal gathering spaces contained in a new entry.



Forum Open Space: Engineering Quadrangle



Forum Open Space: Engineering Quadrangle



IMPLEMENTATION

The 2017 Campus Master Plan considers the sequence of steps required to implement campus development. The phases do not dictate when projects will be completed; rather, they illustrate a potential path for campus development to meet the current and anticipated needs.

If buildings are to fulfill their civic role as described in the Campus Master Plan, requirements for landscape and public space enhancements must be accommodated in the program and budget of each proposed building. Connectivity is also critical to a functional campus, so consideration must be given to planning service and emergency vehicle access, ADA accessible parking, pedestrian and bicycle access, and storm water management to weave the building and the site into the campus fabric.

Finally, the plan recommends improvements which do not have a well-defined time frame, such as landscaping and streetscaping the campus edges. When possible, these enhancements should be included whenever streets are upgraded and considered when new parking or building projects are being programmed and funded. By requiring a high level of integration for each step in campus development, long-term investments in infrastructure can be effectively planned and the benefit of that investment more fully realized.

As the 2017 Campus Master Plan began, several projects were already in planning and design development stages, including the Agriculture and Life Sciences Plant Pathology Building, Music Activities Center, White Creek Community Center, HSC Research Building, Electrical Sub-Station at Research Park, Intramural Complex, Track & Field Stadium, Softball Stadium, Equine Center Phase 2, Student Services Building, Gardens and Greenway Project, White Creek Detention Ponds, and then Engineering Quadrangle. Projects being completed through Private Development includes Park West Development, Cain Hall Site Redevelopment, and Century Square.

In Planning and Design Development

1. AgriLife Sciences Plant Pathology Building
2. Music Activities Center
3. White Creek Community Center
4. HSC Research Building
5. Electrical Sub-Station
6. Intramural Complex
7. Track & Field Stadium
8. Softball Stadium
9. Equine Phase II
10. Student Services Building
11. 21st Century Classroom Building
12. Gardens and Greenway Project
13. White Creek Detention Ponds
14. Engineering Quadrangle



First Phase: Immediate High Priority (0-5 Years)

The first phase of the work is focused on exterior spaces and connections that will directly improve the experience of the campus. These projects are 'quick wins' that will serve an immediate impact on the campus as a result of the 2017 Campus Master Plan. Included are the conversion of small surface lots on east campus to green space, improvements to historic outdoor spaces, conversion of campus roadways to pedestrian malls, and the creation of a West Campus Quad to activate development on West Campus. Supporting future development in West Campus, Olsen Boulevard is altered

Most of these projects are located in the more developed areas of campus, such as Northside and Historic Core. During this phase the University will create programming and specifications for the new signage standards and their implementation.

Landscape Improvement

Projects:

1. Campus Gateway Improvements
2. Renovate Evans Library Malls
3. Renovate Cushing Quadrangle
4. Lamar Street Pedestrian Mall
5. Nagle Street Pedestrian Mall
6. Spence Street Pedestrian Mall
7. Houston Street Pedestrian Mall
8. Remove Lot 21, replace with green space
9. Remove Lot 19, replace with green space
10. Remove Lot 15, replace with green space
11. Remove Lot 23, replace with green space
12. Create Northside Housing Quadrangle
13. Renovate Simpson Drill Field
14. Renovate East Quadrangle

15. Gardens and Greenway Project (in progress)
16. White Creek Detention Ponds (in progress)
17. Create Engineering Quadrangle (in progress)
18. Restore J.K. Williams East Lawn
19. West Campus Quadrangle
20. Olsen Boulevard Roadway Alterations
21. Agronomy Road Streetscape Improvements

Building/ Exterior Projects:

22. West Campus Pavilion
23. On-Campus Housing Connections (North and South Housing Precincts)
24. Construct Campus Front Parking Garage



Northside Housing Quadrangle and New Housing Connection



West Campus Quadrangle and Pavilion



Lamar Street Pedestrian Mall

Phase I Projects: 0-5 years

1. Campus Gateway Improvements
2. Renovate Evans Library Malls
3. Renovate Cushing Quadrangle
4. Lamar Street Pedestrian Mall
5. Nagle Street Pedestrian Mall
6. Spence Street Pedestrian Mall
7. Houston Street Pedestrian Mall
8. Remove Surface Parking and Replace with Green Space
9. Create Northside Housing Quadrangle
10. Renovate Simpson Drill Field
11. Renovate East Quadrangle
12. Gardens and Greenway Project (in progress)
13. White Creek Detention Ponds (in progress)
14. Create Engineering Quadrangle (in progress)
15. Restore J.K. Williams East Lawn
16. West Campus Quadrangle
17. Olsen Boulevard Roadway Alteration
18. Agronomy Road Streetscape Improvements



Second Phase: Medium Priority (5-10 Years)

The second phase of work is focused on beginning to create density in some of the underdeveloped areas of campus such as West Campus, Research Park and Southside. This phase also focuses on targeted infill across the entire campus. New development should occur adjacent to existing buildings and along street edges, leaving the internal infill opportunities for the next phase of development. The areas identified in the corresponding diagram are areas where major roadway alterations are not affecting the specific building sites highlighted. Therefore, these projects can be completed devoid of these major infrastructure projects. During this period, the University will continue to phase in the new signage systems concurrent with project based and funding based approaches. *For more specifics on the implementation of wayfinding and signage systems, see Chapter 8 Wayfinding and Signage.*

- West Campus development should occur along Wellborn Road to reduce the physical and psychological separation between the east and west portions of campus. In addition, development adjacent to the existing Agriculture Complex along Kimbrough Road will begin to realign the zone back to the framework of the campus. An addition will need to be placed on SUP-1 to accommodate the new square footage in the zone.
- Research Park development should occur within the north of the zone beginning with infill buildings and along the south edge of Research Parkway on the existing RV Lot. A new SUP will need to be constructed to accommodate the new square footage in the zone. Maintenance and Grounds will be relocated from Hensel Park to a site adjacent to the new SUP to prepare Hensel Park for future transformation.
- A few new buildings should be constructed on east campus to continue to meet density goals in these areas. Infill opportunities in the Northside Character Zone such as the northeast corner of Old Main and Wellborn Road, Demolition and replacement of Henderson Hall, and the demolition and replacement of RDMC, EIC, Halbouty Addition, and Doherty should be explored. These sites will help psychologically bridge the gap between east and west campus and physically connect the Northside and Historic Core to the development in West Campus occurring during this phase. Any building that is being considered for demolition must be assessed through the Heritage Conservation Guidelines for Demolitions. *For more information on the demolition process, see Chapter 7 Heritage Conservation.*



Pocket Park at SUP1 Addition - West Campus



Bizzell Street Between Polo Road and Ross Street will be Reduced from Four Lanes to Two in Order to Reduce and Calm Traffic



Pocket Park at SUCP1 Addition - West Campus

Phase II Projects: 5-10 years

1. Northside Infill Development and Creation of the New Northside Parking Garage
2. Wellborn Road Development
3. Kimbrough Road Development
4. North Research Park Development (infill opportunities)
5. Health Science Center Expansion I
6. Satellite Utility Plant Development or Expansion
7. Relocated Maintenance and Grounds
8. F and B Roadway Streetscape Improvements and new connection to HSC off Traditions Drive
9. Reduce Bizzell Street
10. Reduce Lewis Street



Long Range Plan (10-15 Years)

The third phase of work is a continuation of creating density and open space in the underdeveloped areas of campus, specifically within West Campus and Research Park. Development adjacent to existing buildings and along street edges should be substantially complete, leaving the internal infill opportunities for this phase of development. Buildings within the Historic should be assessed for potential replacement. Any building that is being considered for demolition must be assessed through the Heritage Conservation Guidelines for Demolitions. Before a building is decided to be demolished, alternatives to demolition such as adaptive reuse, preservation, rehabilitation, restoration or reconstruction should be explored.

- West Campus development should occur along Olsen Boulevard as the area becomes denser and more populated. This development is enabled by the Phase 1 alteration to Olsen Boulevard that created new space for additional interior buildings. The alteration is to move the existing jog in Olsen slightly north and south to create a larger pedestrian-priority area for West Campus.
- Research Park development should occur internally to the west of the northern stretch of Research Parkway, which is rerouted to its east edge to accommodate interior buildings along the current median. This also includes a new parking garage to accommodate the growing population in this area.
- The southern portion of Research Parkway is rerouted further west and Kimbrough Road is extended to create a new loop connection.
- New on-campus housing should be constructed on West Campus as Phase II to the White Creek Development. This new cluster of residence halls and apartments will create a critical mass of on-campus residents to align with the other housing precincts. This includes a new parking garage to accommodate the new population to this area.
- Buildings within the Historic Core with low density, low FCI and site opportunities should be assessed for potential replacement – including Thompson Hall, TAES Annex, Heaton Hall, and Biological Science Building West and Biological Sciences Building East. *For more information on the demolition process, see Chapter 7 Heritage Conservation.*
- Hensel Park is transformed to include ponds, trails, recreation fields and new spaces for the community to gather.



New Parking Garage on the Northwest of Research Park



Development in West Campus Focused Along Olsen Boulevard



Hensel Park Improvements

Phase III Projects: 10-15 years

1. Olsen Boulevard Development
2. North Research Park Development (west of Research Parkway) and Research Park - North Parking Garage
3. White Creek Housing Phase II and West Campus Boulevard Parking Garage
4. University Drive and Agronomy Road Field, Facility, and Agronomy Parking Garage Developments
5. Historic Core Infill Development
6. Health Science Center Expansion II
7. Hensel Park Renovation and Area Development
8. Athletic Facility Expansions
9. Kimbrough and Research Parkway Road Alterations

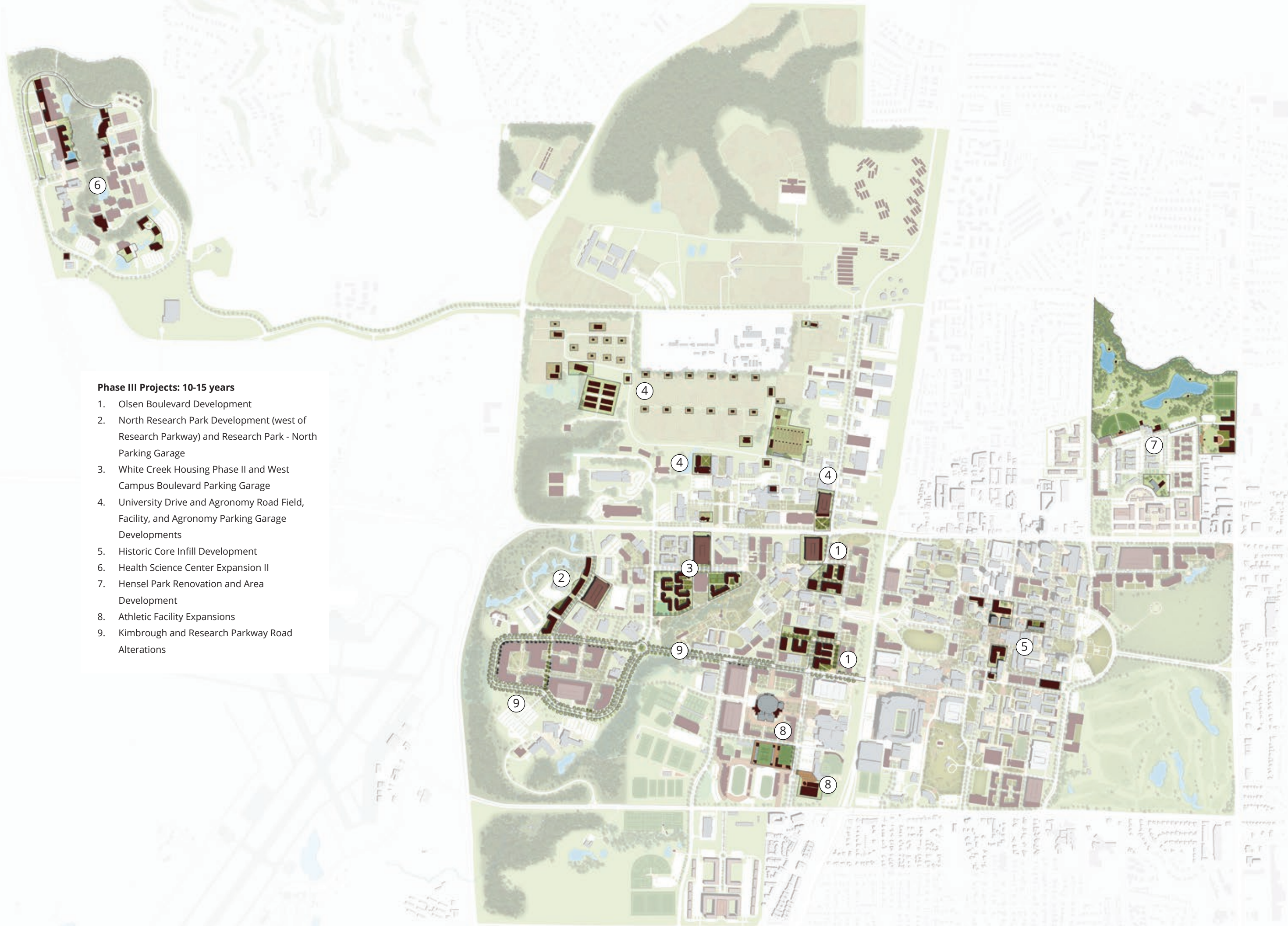

Future Development (15+ Years)

The final phase of work is long-term, occurring 15 years and beyond present. At this time, the campus should have substantial density on West Campus and Research Park. Areas such as the Campus Front, Reed Arena, South of Lewis Street and east of Research Parkway are potential areas of program growth in the long term. In order to prevent further decentralization, these areas should only be explored once the density in West Campus and Research Park is substantial.

- Reed Arena surface parking lots offer 30 acres of land for development and structured parking, both of which are more environmental responsible uses for the land. These buildings have potential uses as retail, entertainment, or administration functions. The two parking garages planned for the west side of the site replace all parking spaces currently on the surface lots and will further support events.
- In this final phase of Research Park, new development occurs on development sites created by the major road alterations during the previous phase. These sites, internal to the realigned Research Parkway, are pedestrian-centric and are linked to previous development in Research Park along a pedestrian mall.
- If demand calls for additional housing, the Southside Character Zone and Hensel Park area offer significant areas for growth near current housing. Both areas would require additional parking.
- The Engineering Activities Buildings were recently renovated, but in 15+ years will need to be assessed for their long-term viability in the area. These buildings are low density and do not contribute to the character of the zone.
- The Campus Front Character Zone (east of Bizzell Street) offers opportunity for growth as the Northside academic programs grow overtime. The use of the Campus Front should be an assortment of mixed-use programs, academics, administration, public programs, and partnerships.



Campus Front Development



Road Alterations in Research Park Create New Infill Development Sites that Better Align into the Campus Framework



Reed Arena Development

Future Development: 15+ years

1. Research Park Phase III Buildings/
Quadrangle
2. Reed Arena Development and Parking
Structures
3. Demolish and Replace Support
Buildings east of Adriance Lab Rd. and
West of Ag Complex
4. New Southside Housing Development
and Parking Structure
5. New Housing located at Hensel Park
6. Develop Campus Front mixed-use
buildings
7. Continued Historic Core Assessment
and Potential Redevelopment
8. Health Science Center Expansion III





04

MOBILITY AND SAFETY

- Introduction
- Proposed Mobility Strategy
- Pedestrian-Priority Zone
- Bicycle Network
- Transit Network
- Service and Emergency
- Roadway Alterations
- Parking Alterations
- Game Day
- Related Transportation Initiatives



WELCOME TO IRELAND AT&M

A&M

Ireland
Ross St

STOP

DO NOT ENTER

201



INTRODUCTION

Mobility is a critical part of experiencing Texas A&M University's large campus.

Moving the University's population across the large campus for daily activities creates an enormous amount of movement both on, and off campus. From an on-campus residents walking to class, to off-campus residents relying on the transit system, and service vehicles accessing buildings for deliveries and repairs, each of these systems must align harmoniously to create seamless, convenient, and safe experiences for all campus users.

The 2017 Campus Master Plan relies on a hierarchical mobility structure focused primarily on pedestrian safety. The diagram to the right displays the mobility hierarchy and includes the primary means of mobility. The preferred travel modes for campus users are walking, biking, and on-campus transit. These modes have the lowest environmental impact and also support campus wellness initiatives.

The vision to create a pedestrian-focused campus entails a mobility system that relocates vehicles away from the center and uses the recovered areas for the highest and best use of University land. This mobility approach improves the quality-of-life for campus users by creating more opportunities for the exchange of ideas, chance meetings, and places to collaborate and socialize.

Vehicle parking is encouraged along the campus perimeter by the future construction of structured parking which will serve as transition points to switch travel modes from vehicle to walking, cycling, or transit. A perimeter parking strategy poses little inconvenience to travelers because once on campus, little time is typically lost by walking or cycling compared to driving short distances and parking a vehicle.

The plan also encourages separation or restriction of mixed travel modes in order to emphasize both pedestrian and cycling safety. Examples include bicycle dismount zones in congested malls between building clusters where there are high concentrations of pedestrians, particularly during class change times, and the construction of bicycle facilities separate from vehicle traffic. The plan also promotes pedestrian and cyclist safety by proposing additional grade separations at major roadway junctions, in addition to grade separations already planned.

The goal of the following Mobility Hierarchy is to realize a campus that emphasizes a more urban experience, prioritizing pedestrians, cycling, and transit.

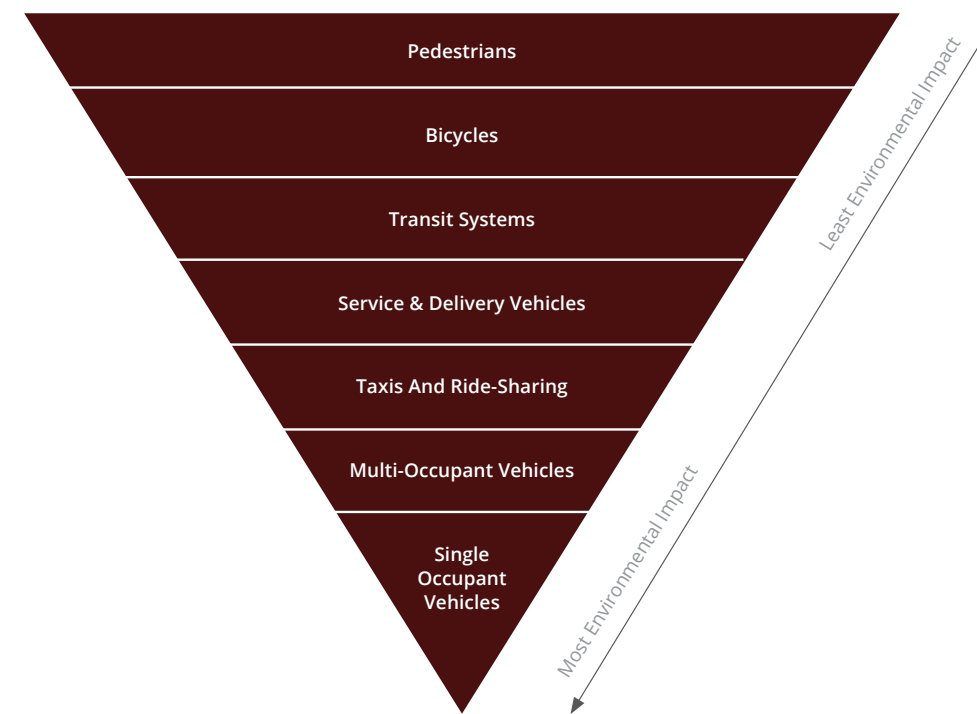

Mobility Plan Hierarchy



Placing pedestrians at the top of Texas A&M's mobility hierarchy decreases the environmental and economic impact mobility has on campus greenhouse gas emissions. Strategies identified in this chapter support a high-performance transit network to access campus amenities.

PROPOSED CIRCULATION STRATEGY

Pedestrian-Priority Zone

The physical outcome of the Mobility Hierarchy is the Pedestrian-Priority Zone, which is an area of campus that gives priority to pedestrians and limits most vehicle traffic. The zone ties the campus core together in an attractive, seamless, and intuitive way by closing select interior roadways and relocating parking to the campus perimeter and creating an internal network of improved multi-use pathways. The Pedestrian-Priority Zone is not a physical barrier to vehicles, but instead a planning tool for future development to prioritize pedestrian connections over vehicular access within this area.

The expansion of, and support for the Pedestrian-Priority Zone on campus has been a driving theme for the 2017 Campus Master Plan and builds upon the 2004 Campus Master Plan's stated goal to "establish an accessible, pedestrian campus." The 2004 Campus Master Plan indicated a 'Pedestrian Activity Zone' that covered most of the Historic Core and stretched across Wellborn Road using a system of planned grade separations while keeping private cars to the periphery.

Concurrent with the implementation of the 2004 Campus Master Plan, a cultural shift began to occur as many internal campus roads (such as Ross Street) became multi-use, limited access roadways that give priority to pedestrians and cyclists during week-day, daytime hours. The grade separations along Wellborn Road also allowed students to seamlessly traverse between the East and West Campus. Many large surface lots were replaced with buildings, pushing parking to the perimeter of campus and into structured parking garages.

The 2017 Campus Master Plan builds on this momentum by strategically removing internal campus roadways and parking lots to renew the commitment to prioritizing pedestrians. In addition, a bicycle dismount zone in congested areas of the campus will further increase safety for pedestrians. Expanding the bicycle dismount zone gradually through phases, mall by

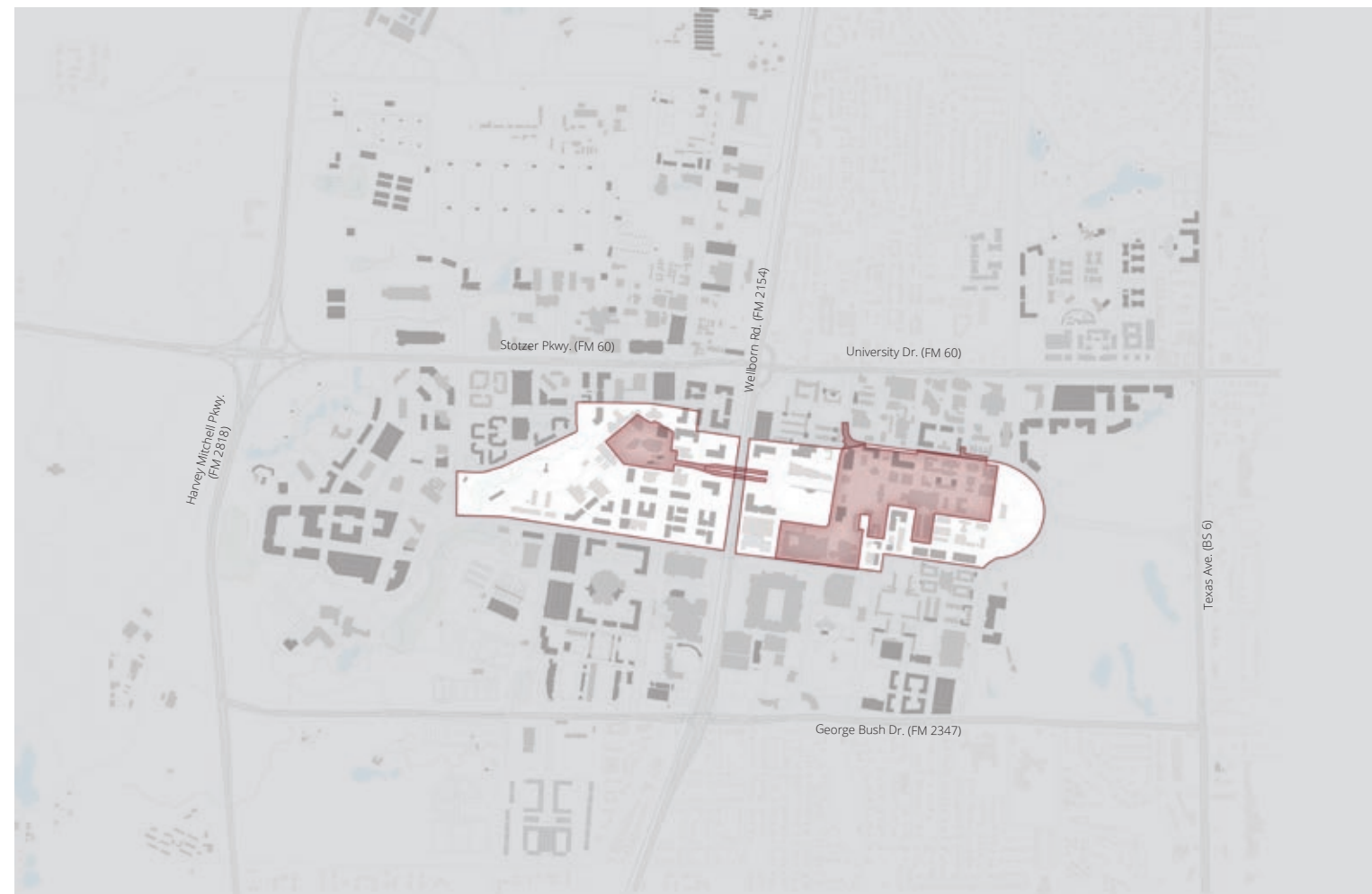



2004 Campus Master Plan Pedestrian Activity Zone vs. Actual, Existing Pedestrian Zone

Current Conditions

- Existing Pedestrian Zone
- 2004 Campus Master Plan Pedestrian Activity Zone

mall and quad by quad, rather than all at once, will allow students to adapt their movement patterns incrementally as this new policy is established. These strategies advance the shared goal of the 2004 and 2017 Master Plans and fosters a pedestrian environment that supports the additional guiding principles of promoting sustainability, and establishing connectivity by creating a richer social environment.

Proposed Pedestrian-Priority Zone

-  Proposed Pedestrian-Priority Zone
-  Proposed Buildings
-  Existing Buildings
-  Proposed Parking Structures
-  Proposed Parking Structures - Alternate Location
-  Existing Parking Structures

Harvey Mitchell Pkwy.
(FM 2818)

Stotzer Pkwy. (FM 60)

University Dr. (FM 60)

Wellborn Rd. (FM 2154)

George Bush Dr. (FM 2347)

Texas Ave. (BS 6)



In addition to Limited Access Roadways and the Bicycle Dismount Zone, two general strategies for managing pedestrian safety are proposed: increasing the physical separation of pedestrians from vehicles along travel routes and implementing an array of traffic calming techniques at crossings.

Physical separation can be increased by widening walkways and multi-use paths to accommodate more foot and bicycle traffic as well as by the use of raised buffers to separate pedestrian walkways and sidewalks from vehicle travel lanes. Other treatments, such as fencing, shrubbery, and planters, may be employed to direct the flow of pedestrian traffic away from vehicles and toward grade separations and safe crossing areas. These treatments would be especially useful in high foot-traffic zones such as along John Kimbrough Boulevard, the Kimbrough and Wellborn Road intersection, Kyle Field Plaza, and along University Drive. The 2017 Campus Master Plan's Campus Guidelines, covered in Chapter Six, should be consulted to ensure that pedestrian control treatments are attractive and consistent with the character zone within which they are applied.

A variety of design treatments can be used to emphasize pedestrian priority at street crossings. These "traffic calming measures" slow vehicles at intersections, encourage travelers to use other paths, or improve driver awareness of pedestrians. These devices will be most necessary at important pedestrian crossings along the periphery of the Pedestrian-Priority Zone, such as areas of high pedestrian and vehicular concentration (Bizzell Street between Ross Street and University Drive) and areas of higher vehicular speeds (Kimbrough Boulevard and Penberthy Road). Examples of traffic calming measures range from simple devices to more assertive means:

- **Crosswalks** (Fig. 1): Marked part of a road where pedestrians have right of way to cross; may be necessary to provide flashing signals
- **Rumble Strips**: Grooves or rows of indents in the pavement designed to alert inattentive drivers through noise and vibration and reduce the number of accidents
- **Speed Tables** (Fig. 2): Mid-block traffic calming devices that raise the entire wheelbase of a vehicle to reduce its traffic speed
- **Curb Extensions/Neckdowns** (Fig. 3): Visually and physically narrow the roadway, creating safer and shorter crossings for pedestrians while increasing the available space for street furniture, benches, plantings, and street trees.

The City of College Station is implementing physical improvements and signal timing changes along University Drive between College Main Street and Bizzell Street, as well as developing an off-campus network of pedestrian malls and enhanced walkways to facilitate pedestrian and bicycle movement and improve safe pedestrian crossings in that area. Initiatives of this type are important at the campus periphery to create a unified, coordinated system of pedestrian and multi-modal support between town and campus. The University should coordinate their own efforts at the campus periphery to ensure University paths and City of College Station paths are well connected.

Shaded walkways are important for pedestrian comfort in the hot, humid Texas climate. Particularly on such a large campus where pedestrians trips are lengthy, it is important that the network of pedestrian paths provide a consistent degree of shelter from the direct sun. Pedestrian shading also can encourage less reliance on air-conditioned vehicles to move around campus, and can foster a greater degree of social interaction to build community connectivity. The Campus Guidelines, located in Chapter Six, discuss the location and details of shade trees and architectural devices for shading.

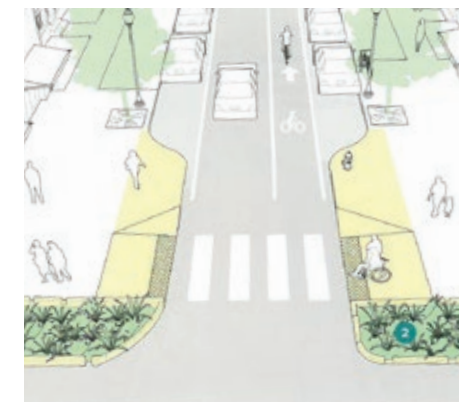
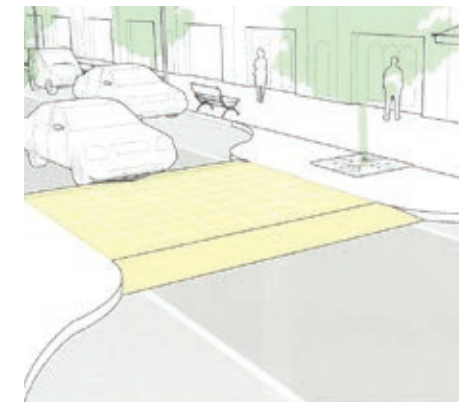

From top to bottom: Fig. 1, Crosswalk; Fig. 2, Speed Table; Fig. 3, Curb Extension.

Images from *Urban Street Design Guide* (2013). New York, NY.: National Association of City Transportation Officials.

Proposed Pedestrian-Priority Network

- Proposed Pedestrian-Priority Zone
- Proposed Buildings
- Existing Buildings
- Proposed Parking Structures
- Proposed Parking Structures - Alternate Location
- Existing Parking Structures
- Road Tables at Pedestrian Crossings
- Pedestrian Malls
- Existing Grade Separations
- Suggested Grade Separations
- Planned Grade Separations

Harvey Mitchell Pkwy.
(FM 2818)

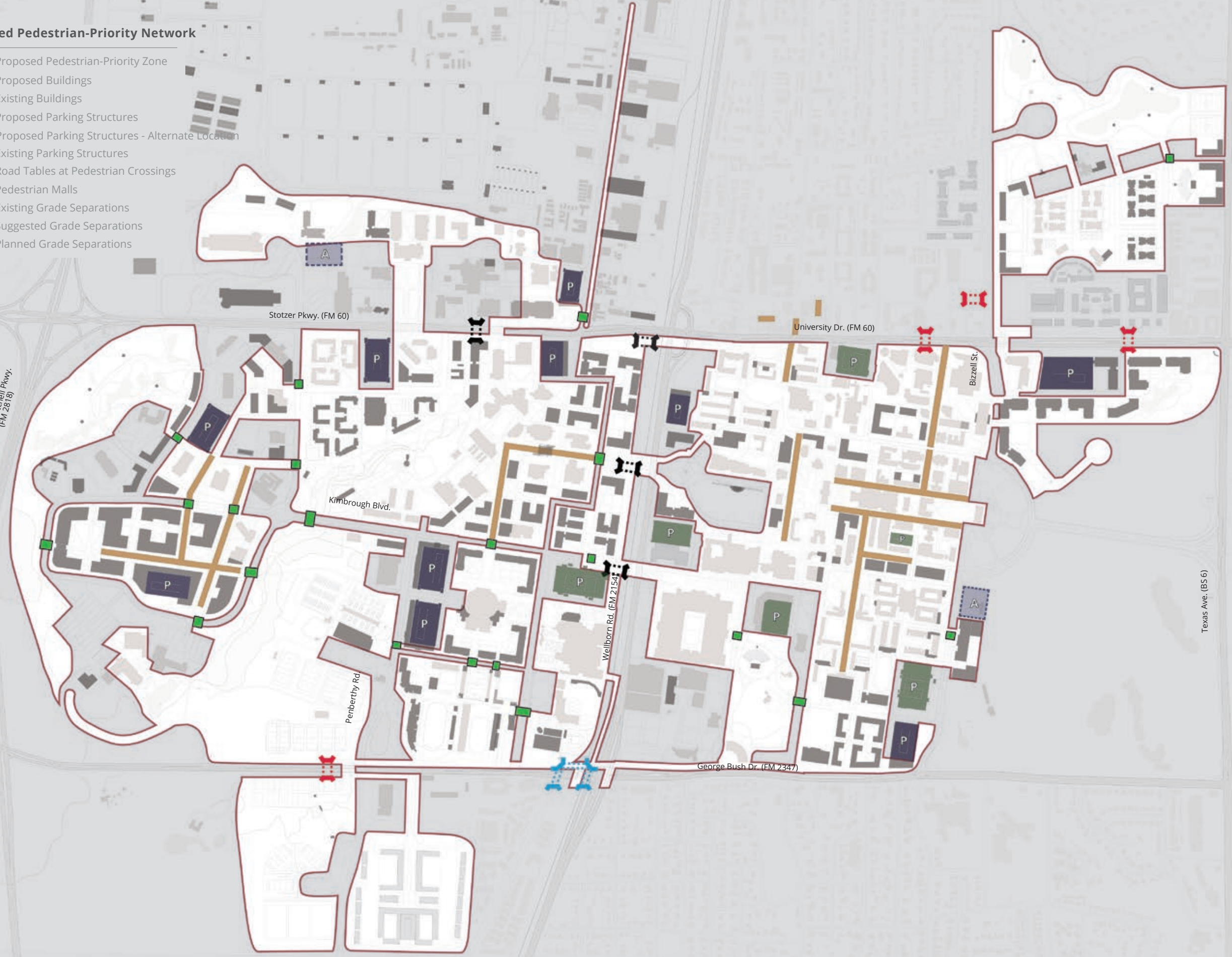

Texas Ave. (BS 6)

Grade Separations

A grade separation is the alignment of two or more surface transport axes at different heights to eliminate disrupting traffic flow at their intersection. Three grade separations exist along Wellborn Road: at Old Main Drive, at University Drive-Stotzer Parkway, and at Kimbrough-Joe Routt Boulevards.

- The grade separation at Old Main is highly utilized by pedestrians traveling between east and west areas of campus. However, due to the lack of development in its immediate vicinity, it is not as successfully tied into the campus pedestrian system. Development around the Old Main and Wellborn intersection will drive more foot traffic into this area and increase use of the underpass.
- Future development along University Drive will boost foot traffic through the University-Stotzer separation. To better support development, the underpass needs improvements including lighting that clearly marks pedestrian and bicycle paths, and aesthetic upgrades to create a safer, more positive experience. The pedestrian crossings at the on and off ramps from Wellborn and University also need improvement for pedestrians to cross safely. Treatments to discourage street-level crossings and direct pedestrians toward the underpasses, as described in the preceding pages, are desirable at all existing grade separations.

A new grade separation is included in current plans by the Texas Department of Transportation at the intersection of Wellborn Road and George Bush Drive. This separation will accommodate pedestrians and cyclists on a complex of bridges through the George Bush and Wellborn Road interchange, and will provide an important linkage between campus and town pedestrian paths.

Additional grade separations at the campus perimeter are needed to increase the seamlessness and safety of the Pedestrian-Priority Zone on campus. They should be strongly considered as a means to support crossings between the University and adjacent businesses, offices, off-campus housing and other amenities. These proposed separations also would facilitate better traffic flow during peak travel hours and on event days. By incorporating

attractive landscaping, public art, and park features, the character of future grade separations can be elevated from merely utilitarian to a social node and community asset. A marked bicycle lane, or physical separation between travel modes would be beneficial at all grade separations, as would a stairway or other means of convenient access between grades. Potential locations for new grade separations are as follows:

- **George Bush Drive and Penberthy Road:** Significant development is occurring with the relocation of recreation fields and new off-campus student housing. Because of the large number of students that will be crossing heavily trafficked George Bush Drive, a grade separation across George Bush is recommended at Penberthy Road. The separation may be sited to the west of Penberthy, as shown, to support the recreation and athletic facilities, or to the east, to support off-campus housing.
- **University Drive from Spence Street to Texas Avenue:** Due to the immense amount of development in this area will soon increase the number of pedestrians entering campus from the north. The intersection of Bizzell and University is already a mobility conflict area and additional foot traffic will only add to these conflicts. To maintain efficient vehicle flow without compromising pedestrian and cyclist safety, the Campus Master Plan proposes a cluster of three closely located grade separations. A separation at Spence Street will provide access to campus from housing communities to the north while distancing those modes of travel from the vehicular intersection at University and Bizzell to reduce congestion. Additional separations farther east along University and to the north across College Avenue are also proposed to support the communities northeast of campus who must cross both University Drive and College Avenue-Bizzell Street to reach campus.

A comprehensive study should be conducted to determine the form, exact location, and phasing for all proposed grade separations. The Bryan-College Station Metropolitan Planning Organization will soon complete a study comprehensively addressing University Drive. One of the desired outcomes is an investigation of possible locations for grade separations.







Existing Grade Separation at Kimbrough-Joe Routt



Existing Grade Separation at Old Main Drive and Wellborn Road

Proposed Grade Separation Locations

-  Suggested Grade Separation
-  Enhanced Existing Grade Separation
-  Planned Grade Separation (In Design)
-  Existing Grade Separation

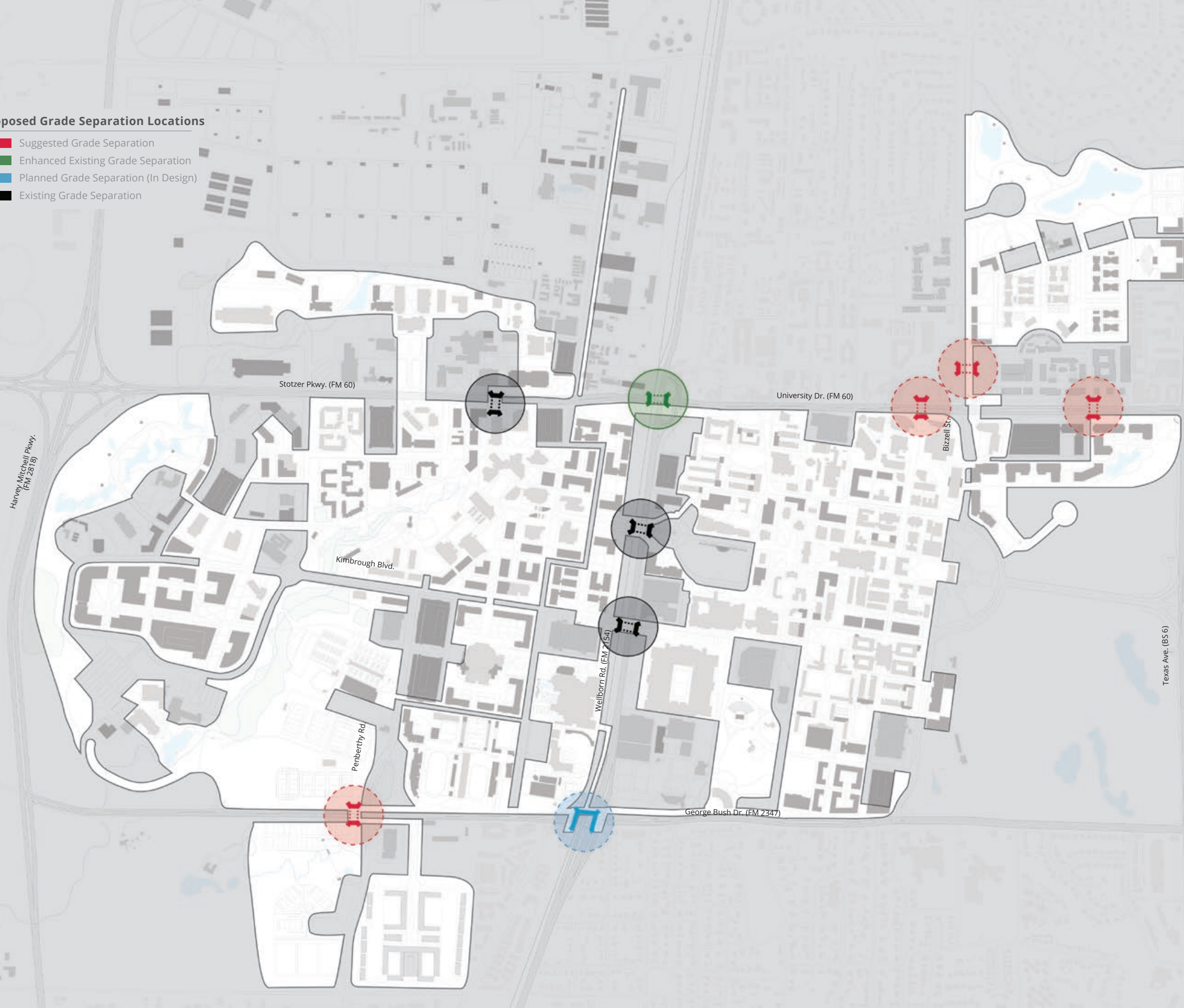

Proposed Bicycle Network

The temperate climate, and relatively flat terrain make Texas A&M conducive to biking. The Texas A&M 2015 Bicycle District Strategic Plan (BDSP) contains recommendations to expand and enhance the University's bicycle program. These recommendations still govern as an in-depth look at the entire system from physical aspects to policies. The 2017 Campus Master Plan outlines areas of the BDSP that need realignment with the current planning effort and offers recommendations beyond the scope of that document.

According to a national study (Dill and McNeil, 2012), skill and comfort levels of cyclists range from Strong and Fearless (1-3%) to those who are comfortable riding on low traffic streets or shared use paths (50-60%). The proposed bicycle network supports riders' safety and traffic concerns by linking all bicycle routes and paths through campus as well as providing connectivity to City of College Station routes. A study of cyclist skill and comfort levels in the Texas A&M and Bryan/College Station communities would assist in fine-tuning campus strategies for bicycle safety.

Discussions with campus cyclists identified inconsistency and lack of connectivity as challenges with the existing bicycle network. When clearly designated cycling areas are not present or well-marked, cyclists are uncertain on which part of the road they belong. Examples of this issue are:

- Cyclists create unsafe conditions for pedestrians by riding on undersized or heavily used sidewalks, such as the walkways adjacent to Evans Library.
- Cyclists face conflicts with vehicles along roads and at intersections that lack adequate lane markings or signage. This can be seen at the intersection of Kimbrough and Olsen Boulevards, where there are no bicycle lane markers. Some motorists also disregard bicycle lane markings and drive or park in bicycle lanes. More visible and clearly worded signage could reduce this problem and aid enforcement.
- Gaps in the network force cyclists into unsafe or inconvenient conditions. This is seen at the signalized crossing at the intersection of New Main and Texas Avenue. There are bicycle lanes on the City of College Station side of Texas Avenue, but no lanes on the campus side.

Separating bicycle paths and routes from roadways is a priority of the proposed bicycle network and implementation depends on whether the right-of-way is wide enough to accommodate separation. When the right-of-way is of sufficient width, bicycle paths and routes are separated by either a marked buffer or a raised vegetated buffer. Where multi-use paths are proposed at the location of present walkways, the general intent is to widen the walkways to a 14' section supportive of shared pedestrian and cyclist use. When the right-of-way does not allow for bicycle paths and routes to be separated, vehicle lanes are narrowed to ten or eleven feet, per National Association of City Transportation Official (NACTO) requirements. This traffic calming strategy reduces the speed of traffic so that cyclists will feel safer and more comfortable riding directly adjacent to vehicle lanes. Narrow roads with low traffic volume, such as Lubbock Street, lack sufficient right-of-way for separate bicycle lanes. In such cases, the vehicle lanes have been converted into sharrows: vehicles and cyclists share the travel lane.

Creating sufficient paths alone is not enough to improve the bicycle network; it is important for preferred bicycle routes to be identifiable. To communicate bicycle transit information, improvements should be made to on-street signage. Up-to-date information about on-campus bicycling should also be available on the University website.

In addition to serving some users' complete transit needs, the bicycle network is also intended to close the gap between on campus parking garages or surface lots and buildings. To encourage biking as a last-mile connectivity solution, there need to be bicycle parking facilities adjacent to vehicle parking locations. Cycling can be encouraged by providing end-of-trip facilities, such as showers and locker rooms, in key destination buildings. A bikeshare program would also support last-mile connectivity.

Progress is being made to link city and campus bicycle networks. Ongoing cooperation and coordination between the University, City, and state entities is vital to ensure that future projects and improvements at the campus periphery continue to enhance this interconnectedness. Opportunities should be sought to cooperatively resolve remaining areas of poor connectivity, such as along Texas Avenue and George Bush Drive east of Wellborn Road.

Types of Cyclists: Comfort and Skill Levels (Dill and McNeil, 2012)

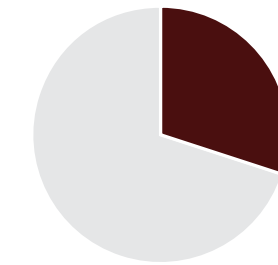

30% No Way, No How

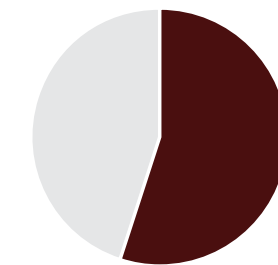

50-60% Interested but Concerned

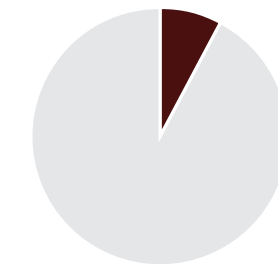

5-10% Enthusied and Confident



1-3% Strong and Fearless

Proposed Bicycle Network

- - - Multi-use Path (coordinate with City and stage agencies as necessary for off-campus paths)
- - - Bicycle Lane
- - - Sharrow (Bicycle Route)
- - - Buffered Bicycle Lane

Existing Bicycle Network

- Multi-use Path
- Bicycle Lane
- Buffered Bicycle Lane
- Municipal Bicycle Routes

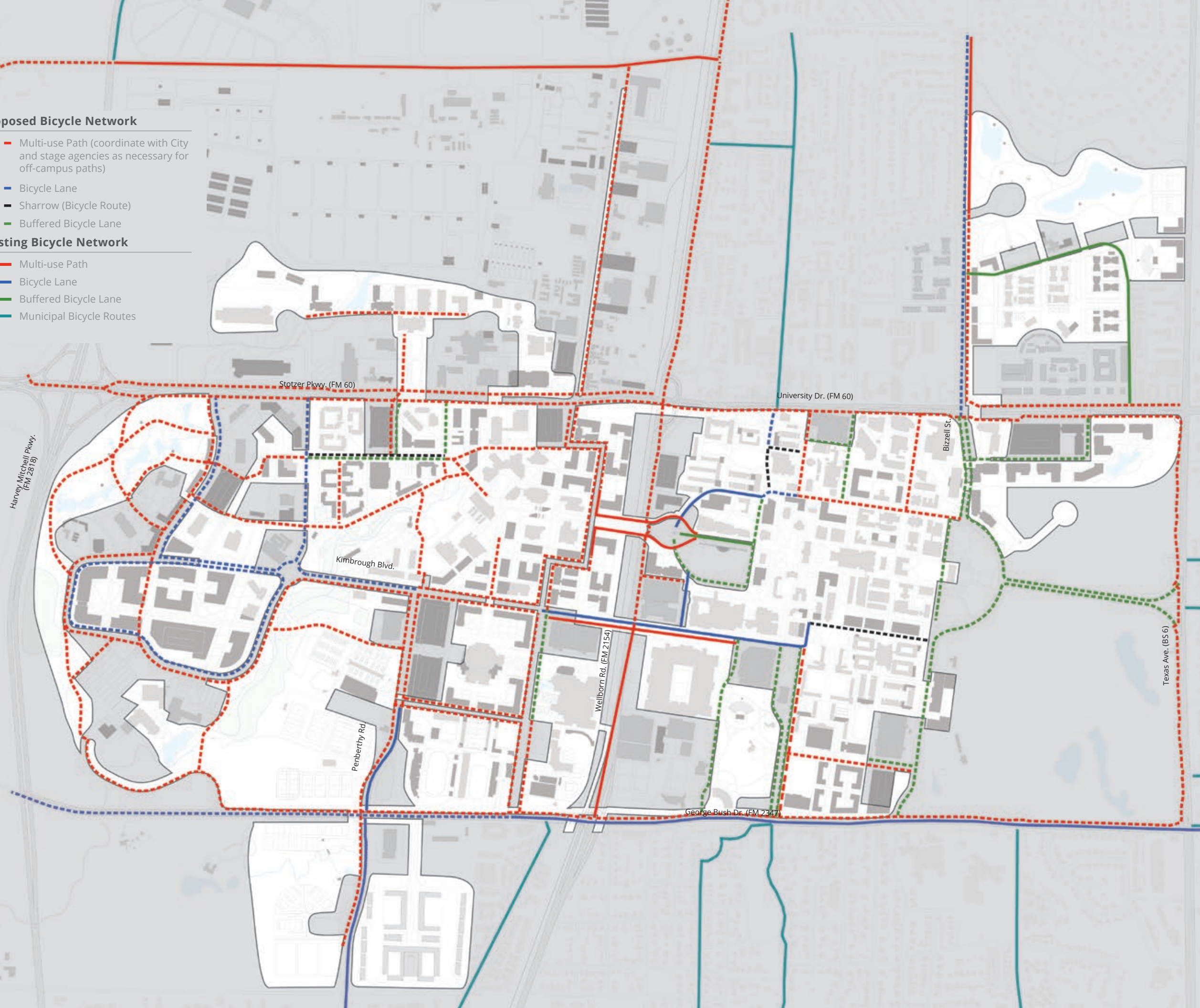

Proposed Bicycle Network Typology

Multi-Use/Shared Use Path

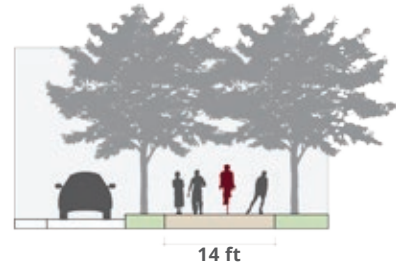

Sidewalks or pathways for pedestrians and cyclists that are separated from the vehicular lanes with an elevated surface.

Recommended Width
Minimum 14 feet wide; Dependent on Existing Right-of-way.

Vehicular Speed
Paths are placed along major roads with a high volume and speed of vehicular traffic where cyclist would feel discouraged and unsafe riding on the road.

Appropriate Signs (with MUTCD labels)



Location
These are generally located on major roads such that cyclists might be uncomfortable riding on the side of the road.

Additional Information
If the right-of-way of the road has a sufficient amount of room, a raised vegetated buffer is encouraged in between the path and vehicular travel lanes. The width of the raised vegetated median is dependent on the right-of-way.

Bicycle Lane

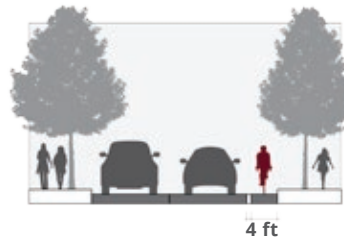

A portion of the roadway that is designated for bicycle users only.

Recommended Width
Minimum 4 feet wide; 7 foot lane width is preferable where the right-of-way allows, to permit cyclists to pass

Vehicular Speed
Traditionally, on roads where the speed limit is 25 mph or more, but are recommended on urban and local streets where the speed may be slower.

Appropriate Signs (with MUTCD labels)



Location
They are generally on roads that provide direct, convenient access to major land uses. They are intended to be on roads with high volumes of vehicular traffic.

Additional Information
This designated bicycle lane is separated by a marked solid white line on the road 4-6 inches wide (can be dotted where vehicles are allowed to enter, at intersections, at bus stops, and at bus pullouts). They are typically one-way travel lanes in the same direction of vehicular traffic. They should be provided on both sides on two-way streets to avoid any "wrong-way" use. If the road is one-way they should normally be placed on the right-hand side of the roadway.

Bicycle Route, or Sharrow

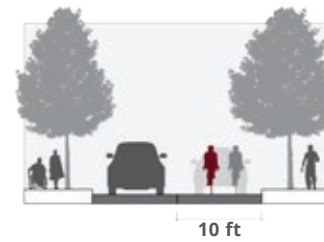

Shared lane for both vehicular users and cyclists due to right-of-way constraints.

Recommended Width
Minimum 10 feet

Vehicular Speed
The speed of these roads vary based on the settings and surrounding of the road, but it should be no higher than 35 mph.

Appropriate Signs (with MUTCD labels)



Location
Minor roads where cyclists share the road with no special provisions.

Additional Information
Traditionally, the traffic volume on these roads is expected to be no more than 1,000 vehicles per day.

Buffered Bicycle Lanes

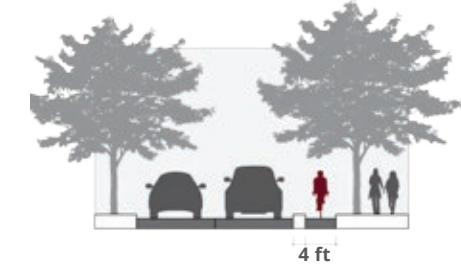

Traditional bicycle lanes on the shoulder of the road that are separated from the vehicular lane (or parking lane) by a designated buffer space.

Recommended Width
Minimum 4 feet wide; allow additional width where the right-of-way allows. Buffers should be minimum 18 inches wide on the side of vehicular traffic. 7 foot lane width is preferable where the right-of-way allows, to permit cyclists to pass

Vehicular Speed
Traditionally, on roads where the speed limit is 25 mph or more, but are recommended on urban and local streets where the speed may be slower and if the right-of-way allows.

Appropriate Signs (with MUTCD labels)



Location
They should be considered on roads with high vehicular speed, high levels of traffic, and if there are high levels of truck traffic.

Additional Information
Generally, these lanes should be placed when the right-of-way allows to maximize level of safety for cyclists. The lanes are recommended to be colored green in areas where vehicles and cyclists may conflict (i.e. right before an intersection). They are recommended to be in the direction of vehicular traffic. The buffer should be marked with 2 parallel solid white lines with diagonal hatching between that is at least 3 feet wide where crossing is prohibited, and dashed lines where crossing is permitted.

References

Guide for the Development of Bicycle Facilities (2012). (Fourth ed.). Washington, D.C.: American Association of State Highway and Transportation Officials.

Urban Street Design Guide (2013). New York, NY.: National Association of City Transportation Officials.

Urban Bikeway Design Guide (2013). (Second ed.). New York, NY.: National Association of City Transportation Officials.

Dismount Zone

The sheer volume of cyclists traveling within certain areas of campus during class change periods is a hazard to pedestrian safety. The high numbers of bicycles, skateboards, and scooters combined with extremely high pedestrian volume creates a commotion that can often lead to collisions. This is especially true in the Historic Core where existing pathways have insufficient width to carry the volume of movement during class change safely.

To increase the safety of pedestrians in the Historic Core and West Campus Quad, a dismount zone policy would require all riders dismount non-motorized wheeled vehicles such as bicycles, skateboards, and scooters to allow for pedestrian-only movement. Precedent for such a policy exists on campus at Rudder Fountain, where cyclists are currently expected to dismount and push their bicycles. The existing dismount zone allows the large concentration of pedestrians in this area to co-exist with cyclists while minimizing collisions.

The dismount zone should be expanded gradually to cover major pedestrian connections and large gathering spaces within Historic Core. This change should not happen immediately, but over time as its success will depend on campus users following and self-enforcing the policy. Institutions such as Arizona State University and UC Berkeley have implemented such zones and they are now adhered to and self-policed by campus users. The University may enforce the dismount zone by issuing warnings and citations to those who do not adhere. The zone will contract on a time-of-day basis, covering the greatest area during primary class hours and contracting as activity diminishes, with zone restrictions lifted entirely during nights and weekends.

Bidirectional bicycle routes are planned to loop around the dismount zone. These routes will channel cyclists away from the dismount zone by making it more convenient to bicycle around the zone than to dismount and walk through it. In addition to expanding the dismount zone, this plan recommends an accompanying program be established to educate cyclists on safe biking practices. This type of program will reinforce the dismount zone policy and help reduce bicycle-pedestrian conflict throughout campus.

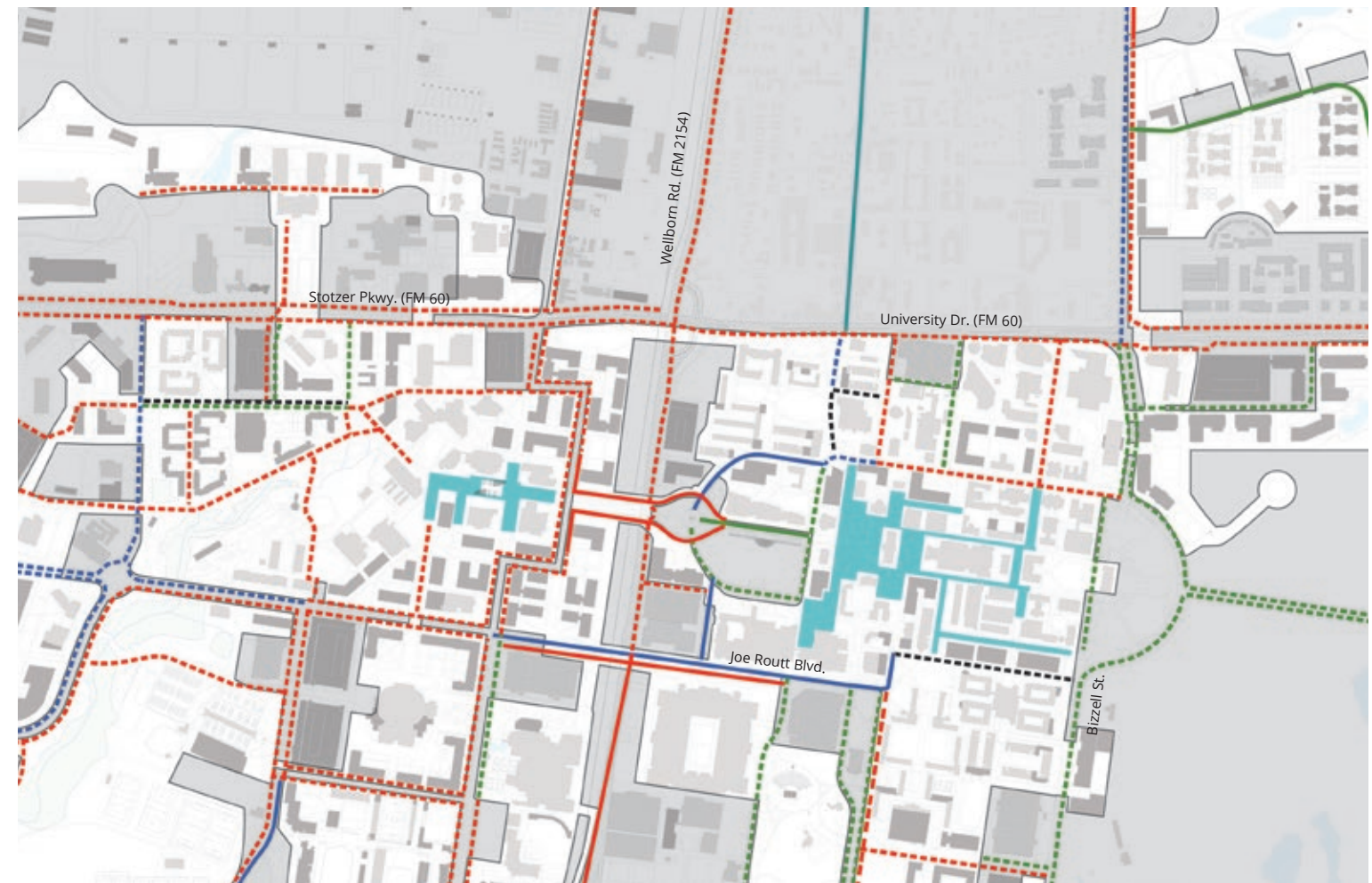

Proposed Dismount Zone



Arizona State University - Walk-Only Zones



University of California, Berkeley - Walk-Only Zones

Proposed Bicycle Network

- Multi-use Path (coordinate with city and stage agencies as necessary for off-campus paths)
- Bicycle Lane
- Sharrow (Bicycle Route)
- Buffered Bicycle Lane
- Dismount Zone

Existing Bicycle Network

- Multi-use Path
- Bicycle Lane
- Buffered Bicycle Lane
- Municipal Bicycle Routes

Bicycle Parking

To accommodate enrollment growth, build on campus wellness initiatives, support the dismount zone, and minimize transit's environmental impact, it is important to encourage cycling as an alternative mode of transportation and consider how to best accommodate bicycle parking. Even with over 15,000 bicycle parking spaces on campus, there is a high demand for additional bicycle parking in some areas. Additional capacity should be planned within the following character zones: Southside, Historic Core, University and Agronomy, and adjacent to the Student Recreation Center.

Buildings with higher transience, such as the Memorial Student Center, or those with large lecture halls have higher demand for bicycle storage. Storage should also be designed to meet the duration of need. Covered storage is preferable for long-term bicycle parking, such as at residence halls, while uncovered bicycle parking is acceptable at academic buildings. In lieu of providing one large bicycle storage area at each building, consider multiple smaller capacity storage areas which tend to result in fewer bicycle tangles. Consult the Bicycle Master Plan for additional guidance and size bicycle parking on a case-by-case basis in consultation with the University.

For short-term bicycle lots adjacent to academic buildings, provide appropriate screening (as per design guidelines) with landscaping or low-walls. Skateboard storage should also be provided at these locations. Long-term facilities should be sheltered with adequate weather protection or placed in secured areas such as freestanding enclosures or within a larger structure such as a parking garage. Consideration should also be given to providing overnight bicycle parking in new parking garages to support daily multi-modal transit strategies. Overnight garage bicycle parking would allow campus users to commute to campus by vehicle but then complete on-campus trips via bicycle from perimeter parking facilities.

A campus bikeshare program would reduce crowding at bicycle parking facilities by lessening the need for privately owned bicycles on campus, and would encourage non-riders to reduce dependence on motorized vehicles and adopt a more sustainable and healthy means of transport.

Collaboration between Texas A&M and the City of College Station to expand the bicycle network, including buffered or separated lanes, sheltered parking, and support facilities would help to further reduce vehicular traffic and emissions, and promote wellness in the broader community.

Design Criteria	Short-Term Parking	Long-Term Parking
Weather Protection	Unsheltered	Sheltered and Enclosed
Safety	Clearly Visible to the public	Secured; Bike lockers, bike room, or cage, surveillance cameras or security guards
Adjacent Land Uses	Library, Classroom Buildings, Lab Buildings, Recreation Centers	On-Campus Housing, Administrative Offices
Location	Approx. 50 feet from the main building access, high traffic area with passive surveillance, adjacent to pedestrian/vehicular corridors with ample space for maneuvering	Away from building entrances or high traffic areas in areas where larger bicycle racks can be installed
Quantity	As a percent of student population in clusters of 10-50 bicycle racks; (good decision is based on an engineering demand study)	As a percent of faculty and staff or a specific facility's long-term user (i.e. residents); (good decision is based on an engineering demand study)
Recommended Design	Inverted U (single or series), post and ring	Wall-mounted, two tier or double decker, covered or within existing buildings

General Bicycle Parking Guidelines - APBP Bicycle Parking Guidelines, 2nd Edition

For more information on Design Guidelines for Bicycle Parking, refer to the Campus Guidelines in Chapter Six.



Existing bicycle parking at the Memorial Student Center, adjacent to the existing Bicycle Dismount Zone



Bicycle drop-off/pick-up at Arizona State University



Secure bicycle storage at Arizona State University



Sheltered bicycle parking
Bike Dock Solutions

Proposed Transit Network

The existing transit network has good coverage and frequency on campus, but expected growth in student enrollment may require more frequent bus service along existing routes as well as additional routes on and off campus. In order to more comprehensively serve the Texas A&M community, the future transit system must adapt to the proposed changes in campus form, parking, and new housing that is being built off-campus. Continuous reassessment of routes will be critical to avoid congestion and meet the expected increase in demand.

Future on-campus transit, pedestrian, and bicycle routes must harmonize with the Pedestrian-Priority Zone and support multi-modal trips. The objective is to make it more convenient for a person on campus to use transit, biking, or walking than it is to move their car throughout the day. Locating transit stops near parking garages with integrated bicycle parking facilities is one way to support this type of connectivity. Retrofitting the campus bus fleet with bicycle racks or purchasing new buses with bicycle racks when existing buses are phased out of service would also support multi-modal trips. Transit stops, hubs, and amenities need regular review to maintain safety, keep pace with growing enrollment, and verify multi-modal connectivity.

On-campus routes will need to provide connectivity between the additional facilities proposed for Research Park and West Campus, and housing and student amenities on East Campus. A circulation route from the Memorial Student Center transit center to Research Park along Kimbrough Boulevard is one possibility to consider. On-campus service will also need to connect new housing clusters to campus centers such as the Memorial Student Center. The planned mixed-use housing/retail/restaurant clusters near campus will draw students and faculty even after class hours and on weekends. Transit with less frequent service should be evaluated to serve these off-peak needs.

On-campus improvements will require close coordination with the Brazos Transit District (BTD) to ensure connections exist beyond the campus boundary. The BTD currently operates two routes that stop on campus: one from the Bryan Transit HUB to Memorial Student Center and one from College Station to Lewis Street. The BTD also serves campus with routes along University Drive and Texas Avenue.

Coordination between campus transit and the BTD can be strengthened physically by providing an on-campus transit transfer stop between Texas A&M and BTD routes serving campus and/or operationally by providing more frequent BTD service to the Memorial Student Center. Routes served by the BTD and Texas A&M should be coordinated to minimize as much as possible the areas of overlapping service that serve the same function, primarily along College Main Street and University Drive north of campus and along George Bush Drive, Anderson Street, and Holleman Drive East south of campus. New off-campus routes should be considered to better serve existing off-campus housing as well as proposed non-University housing communities.

Providing a safer and more pedestrian friendly campus by encouraging vehicles to remain on the perimeter will require transit service at proposed parking garages. An additional circulator bus service within campus to serve major building clusters may be required. The Memorial Student Center is already a magnet for transit activity and might have capacity to serve as a transit hub for transfers between additional service routes, but other transfer points should be considered.





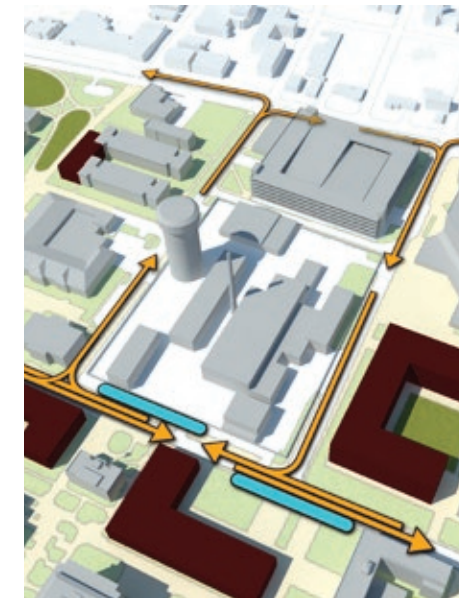





Transit Hub at Memorial Student Center



Proposed Transit Loop at Ireland, Ross, and Asbury Streets. Proposed transit stop locations shown in blue

Proposed Transit Network

-  On-Campus Transit Routes
-  Brazos Transit District Transit Route
-  Timed Stops
-  Demand Stops
-  Proposed Parking Structures
-  Proposed Parking Structures - Alternate Location
-  Existing Parking Structures
-  Transit Coverage (5-Minute Walk to Nearest Stop)
-  Existing or Future Development Underserved by Current Transit Routes

Harvey Mitchell Pkwy. (FM 2818)

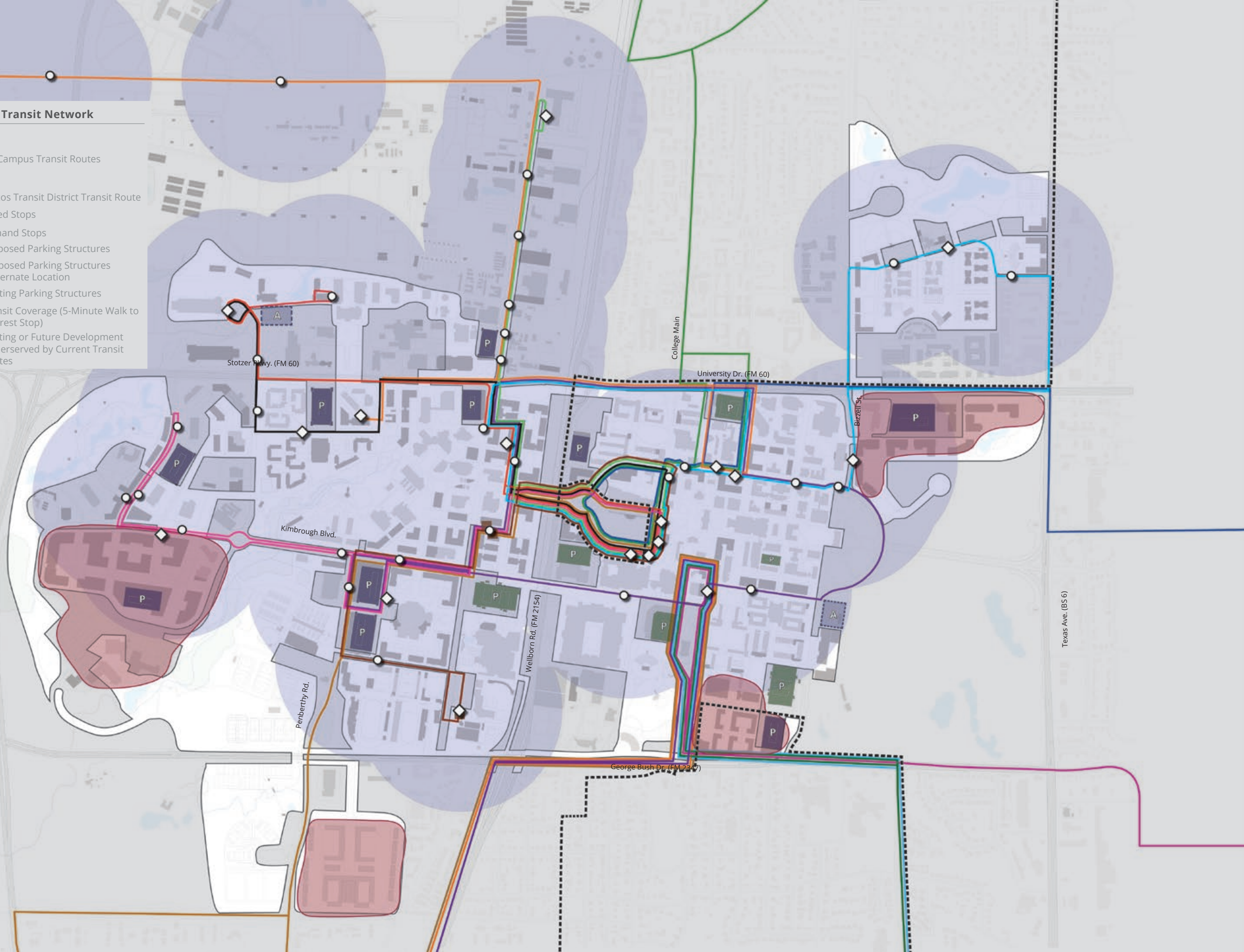

Texas Ave. (BS 6)

Proposed Service Vehicles and Emergency Access

Service Vehicles will be guaranteed access necessary to maintain campus buildings, landscapes, and amenities. The pathways within the Pedestrian-Priority Zone will be wide enough and have pavement strength sufficient to carry vehicle loads. Service areas for adjacent buildings should be consolidated to the extent possible to minimize the distribution of vehicles within the pedestrian zone. Standard protocol should be for service vehicles to travel around the perimeter of the Pedestrian-Priority Zone, then proceed to their destination by the most direct route, rather than traveling point to point through the zone. Only credentialed vehicles will be allowed into the Pedestrian-Priority Zone and time management techniques, including scheduling service outside peak class hours, should be deployed to limit vehicle and pedestrian conflicts when possible. The University plans to publish class change times in all service vehicles so that their movement can be timed to avoid periods of heavy pedestrian activity. Administration and campus service departments should work cooperatively on an ongoing basis to develop, test, and refine policies that will advance culture change while not unnecessarily impeding day-to-day operations

Transitioning the service vehicle fleet from pickup trucks to electric golf carts for most activities would promote safety and sustainability, as smaller service vehicles are less obstructive in the denser areas of campus. Larger vehicles may be retained for heavy duty or equipment-intensive tasks. If space allows, dedicated parking spaces for golf carts should be planned to keep these vehicles out of pedestrian pathways. Refer to Chapter Six, Campus Guidelines for specifics on golf cart shelters. If no parking space exists, service vehicles should be accommodated in pull-off areas from sidewalks and road to minimize infringement on pedestrian movements. Pull-off areas should be as close to buildings as possible.

The Pedestrian-Priority Zone will support emergency vehicle access in compliance with the International Fire Code (IFC). Road tables and other vertical deflections along emergency routes will need to be reviewed by the College Station Fire Department to ensure compliance with the IFC. Parking restrictions will be planned to assure fire hose lengths are not compromised.

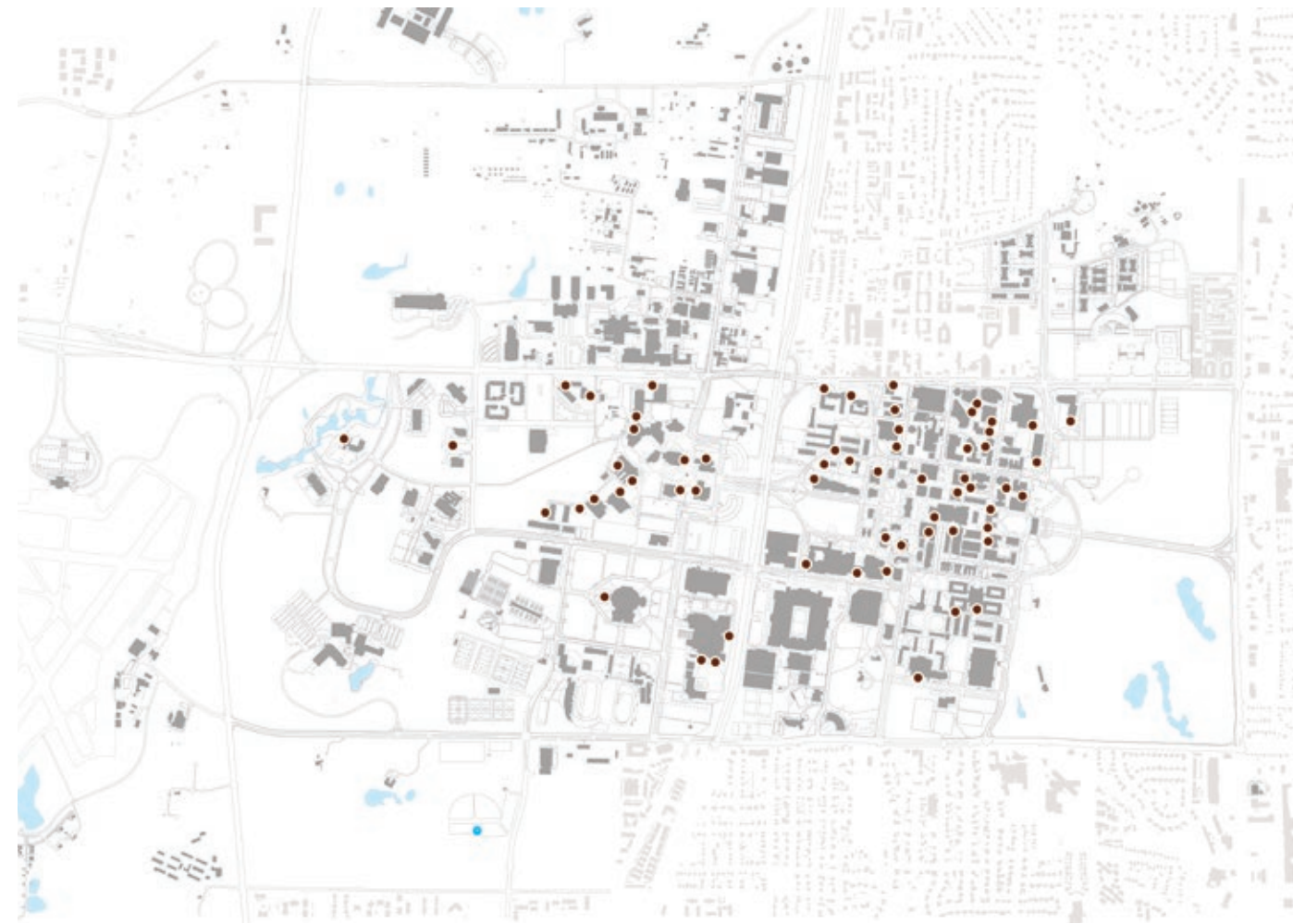

Existing Service Bay Locations

Current Conditions

Existing Service Bays



Small Service Vehicle Parking, Arizona State University







Service Pull Out Area, Texas A&M



Dedicated Service Parking, Texas A&M

Service and Emergency Access

-  Roadways
-  Service Routes
-  Relocated Service Bays
-  Existing Service Bays to remain

Harvey Mitchell Pkwy.
(FM 2818)

Stotzer Pkwy. (FM 60)

University Dr. (FM 60)

Bizzell St.

Kimbrough Blvd.

Penberthy Rd.

Wellborn Rd. (FM 2154)

George Bush Dr. (FM 2347)

Texas Ave. (BS 6)

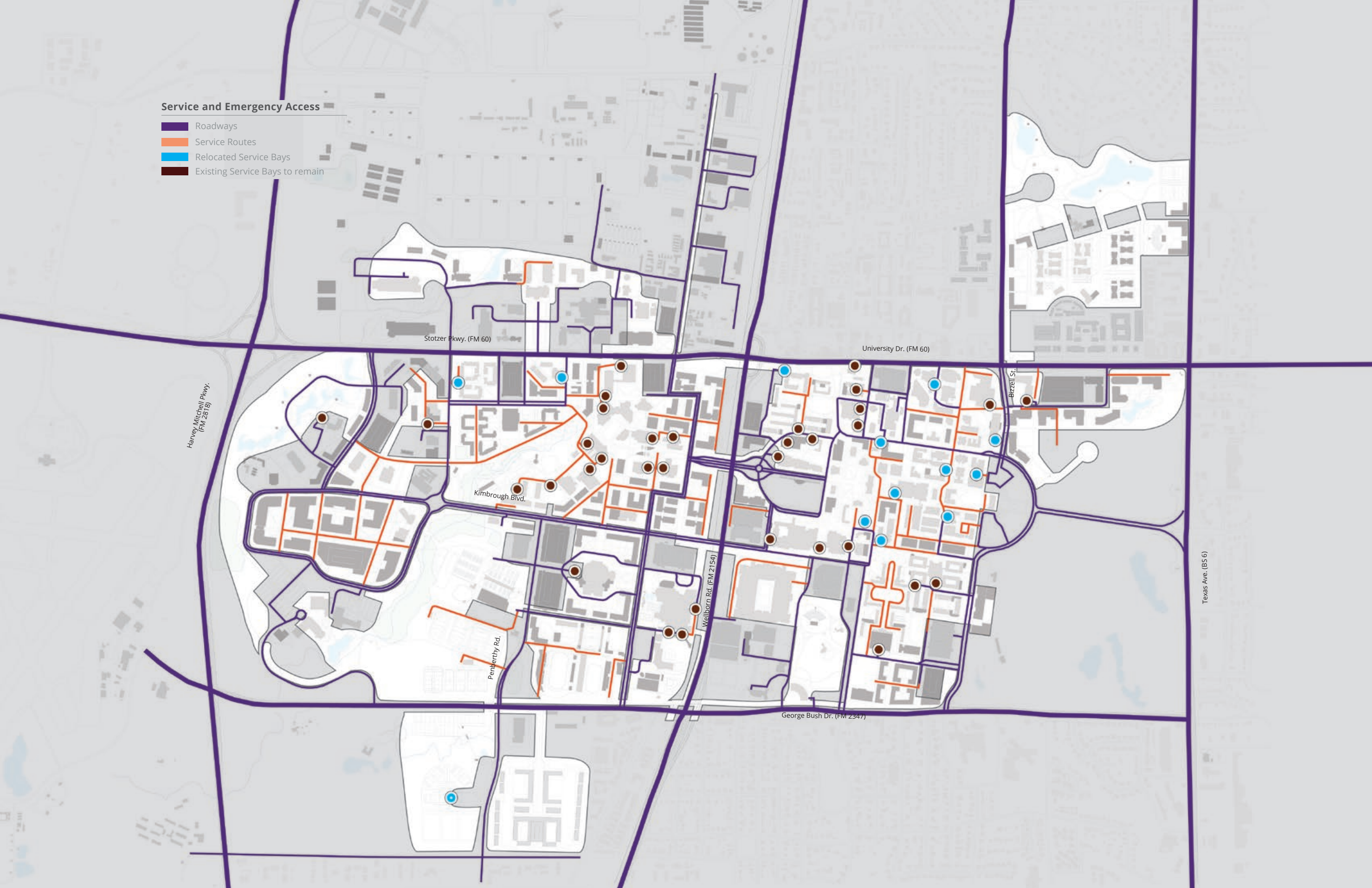

Proposed Road Alterations

Road alterations are coordinated with the siting of existing and proposed parking garages to ensure efficient access from the campus periphery and reduce the presence of vehicles within the Pedestrian-Priority Zone. This strategy aligns with the Campus Master Plan's goal of establishing an accessible, pedestrian campus. The Campus Master Plan's proposed road alterations prioritize:

- Efficient support of future development
- Improving pedestrian safety by reinforcing the Pedestrian-Priority Zone
- Supporting multimodal transportation
- Supporting the perimeter parking strategy
- Providing flexibility for game day traffic management
- Maintaining accessibility for service and emergency vehicles

The alterations fall into three general categories:

1. Limitations on private vehicle access on certain roads
2. Changes to the section of existing roads
3. Road relocations, including demolition and new construction

Limited Access Roadways:

Aligning with the objectives of the Pedestrian-Priority Zone, the Campus Master Plan proposes to limit private vehicle access to certain roads. These limitations may be by time of day, to reduce vehicle presence during peak class hours while allowing greater access at other times; by card access, to provide access to University Central Garage to credentialed staff; or by game day access, where transit-only routes and pedestrian malls are open to private vehicles as part of the University's game day exit strategy.

Unlimited access roads have been preserved or enhanced where they support existing or proposed parking garages, or where they lie outside the Pedestrian-Priority Zone.

Pedestrian Malls

Several roads have been converted from vehicular roads to pedestrian-only malls. These malls will serve as important pedestrian thoroughfares linking key open spaces on campus. They will provide new opportunities for social engagement and improve the quality of campus experience, while allowing service and emergency vehicle access, and locations for food trucks or similar amenities.



Enterprise Ave. Existing Conditions - Vehicular Road



Enterprise Ave. Proposed Conditions - Pedestrian Mall

Roadway	Crossroads	Transit	Bicycles	Service Access	Emergency Access	Cars	Game Day Cars
Lamar Street	Bizzell St., Spence St.	No	No	Yes	Yes	Card Access	Yes
Nagle Street	Lubbock St., Evans Library	No	No	Yes	Yes	No	Yes *
Lubbock Street	Bizzell St., Coke St.	Yes	Yes	Yes	Yes	Time of Day	Yes
Houston Street	Ross St., University Dr.	No	Yes	Yes	Yes	No	No
Houston Street	Old Main Dr., Ross St.	Yes	Yes	Yes	Yes	No	Yes
Ross Mall	Bizzell St., Houston St.	Yes	Yes	Yes	Yes	Time of Day	Yes
Trigon Loop	Joe Routt Blvd.	Yes	No	Yes	Yes	Time of Day	No
Joe Routt Blvd.	Stallings Blvd., Throckmorton St.	Yes	Yes	Yes	Yes	No	No
Spence Street	University Dr., Lamar St.	No	Yes	Yes	Yes	No	No
Ireland Street	New St., Ross St.	Yes	Yes	Yes	Yes	Time of Day	Yes
Asbury Street	New St., Ross St.	Yes	Yes	Yes	Yes	Time of Day	No
Enterprise Avenue	Research Pkwy, Discovery Dr.	No	Yes	Yes	Yes	No	No

Limited Access Roadways

* Nagle St. will be accessible to game day traffic only between Lubbock St. & Lamar St.

Proposed Roadway Alterations

- Unlimited Access, Roadway Improvement
- New Roadway Section
- Pedestrian Mall, Service/Emergency Allowed
- Limited Access, Card Access
- Limited Access, Transit, Service
- Game Day Access
- Existing Unaltered Road
- Widened Existing Road
- Proposed Parking Structures
- Proposed Parking Structures - Alternate Location
- Existing Parking Structures

Harvey Mitchell Pkwy.
(FM 2818)

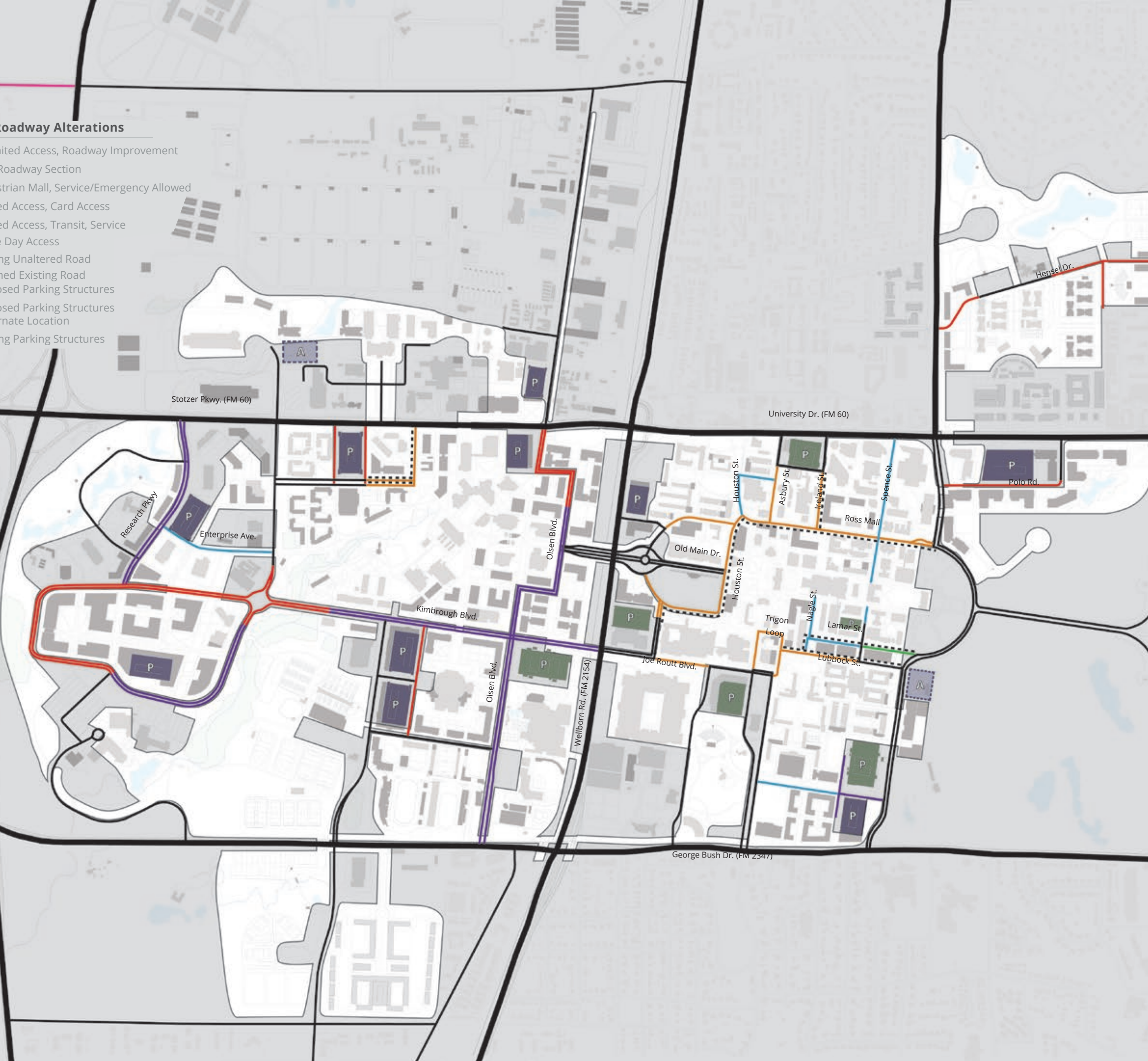

Stotzer Pkwy. (FM 60)

University Dr. (FM 60)

Research Pkwy

Enterprise Ave.

Kimbrough Blvd.

Olsen Blvd.

Olsen Blvd.

Wellborn Rd. (FM 2154)

George Bush Dr. (FM 2347)

Joe Routh Blvd.

Old Main Dr.

Houston St.

Houston St.

Trigon Loop

Trigon Loop

Nagle St.

Nagle St.

Lamar St.

Lamar St.

Lubbock St.

Lubbock St.

Houston St.

Asbury St.

Ireland St.

Ross Mall

Ross Mall

Spence St.

Spence St.

Hensel Dr.

Polo Rd.

Texas Ave. (BS 6)

Roadway Alterations:

As discussed in Chapter Three, the layout and road sections Research Park and West Campus areas have been extensively altered, to prepare for intensive future development. The large medians and parkway sections typical of suburban roads have been narrowed to increase developable space and encourage lower vehicle speeds for pedestrian safety. East Campus roads have largely been designated as limited access or converted to pedestrian-only malls. Throughout campus, roads have been resized to better accommodate multiple modes of transportation in a safe and efficient manner. Adding buffered bicycle lanes, reducing medians, and correctly sizing pedestrian paths and drive lanes increases safety for all campus users. The proposed street sections designate ample amounts of sidewalk space and bicycle lanes and physically separate them from vehicular lanes where possible within each existing street's right-of-way.

New Roadways:

New roads of particular note include the Research Parkway/Kimbrough Boulevard loop encircling a proposed development cluster in Research Park; a relocation of Polo Road, better situated to support long-term front of campus development; and revisions to Hensel Drive, including a connection to Texas Avenue that will be important as development of housing at The Gardens and Century Square proceeds. Olsen Boulevard between Stotzer Parkway and Old Main Drive has been reshaped to provide a more suitable layout for building development and, by sharpening the turns, to reduce vehicle speeds through the Pedestrian-Priority Zone.

F and B Road

The Bryan/College Station Metropolitan Planning Organization (BCSMPO) is exploring extension of the Health Science Center Parkway road section along University-owned F and B Road from Turkey Creek Road to Wellborn Road. This will improve access from Wellborn Road and Harvey Mitchell Parkway to the HSC campus and support the planned growth of that campus. Addition of a multi-use path along this route, as shown in the proposed bicycle network diagram, would improve pedestrian and cyclist connectivity between the Health Sciences Campus and Main Campus.

Kimbrough Boulevard

The Campus Master Plan proposes to extend Kimbrough Boulevard west from its intersection with Discovery Drive and Research Parkway. This extension creates a well-organized space for a building cluster in Research Park. However, the extension creates a large intersection that might create traffic control challenges. A solution to this difficulty might be the construction of a traffic roundabout in lieu of a conventional intersection. A two-lane roundabout with an inscribed circle diameter of 150 feet or greater will accommodate buses and single unit delivery vehicles, allow the intersection to match the existing roadway alignments, and avoid encroaching on existing buildings. A detailed study would need to be conducted in order to determine the most appropriate design for a roundabout at this intersection, including factors such as circle diameter, number of lanes, and design features that could be used to expedite the flow of high volume traffic on game days.

Special consideration will need to be given to how cyclists engage with this intersection. The preferred strategy would terminate proposed bicycle lanes onto shared-use paths to cross the roundabout around the perimeter. Crosswalks on the shared used path should be set back from the vehicle yield

line by one or more vehicle lengths. Separating cyclists and pedestrians from vehicles will create a longer path for them, but there are numerous safety benefits to having a shared path around the roundabout:

- By providing space to pause on splitter islands, pedestrians and cyclists can consider one direction of traffic at a time which simplifies crossing the street.
- Separating vehicle-vehicle and vehicle-pedestrian conflict points reduces the amount of incoming information drivers approaching or traveling through the intersection must process at the same time.
- Because crosswalks and the roundabout will be separated, the second entering driver can devote attention to crossing pedestrians while waiting for the driver ahead to enter the circulatory roadway.

The relatively slow vehicle speeds and a reduced number of conflicts are two primary reasons that roundabouts can be safer than a standard intersection. Lower speeds combined with well-defined crossings and splitter islands result in relatively high rates of motorists yielding to pedestrians at most roundabouts, making it easy for pedestrians to cross.

Providing a roundabout at the intersection of Kimbrough Boulevard, Discovery Drive, and Research Parkway will also break up the straight line created by the extension of Kimbrough Boulevard. Motorists have a tendency to increase their speeds on straight roadways with long forward vistas. By providing a landscaped roundabout central island, motorists' views will be broken up and their tendency to speed will be discouraged.



Proposed Changes to intersection at Kimbrough Boulevard and Discovery Drive

Traffic Roundabout

A type of circular intersection or junction characterized by continuous traffic flow in one direction around a central island. By entering the circle tangent to the traffic flow, vehicles require only a "yield" condition, rather than the "stop" condition required by a conventional traffic circle in which the approach is perpendicular to the flow of traffic. This design reduces the severity and likelihood of accidents while eliminating the need to stop before entering the intersection.

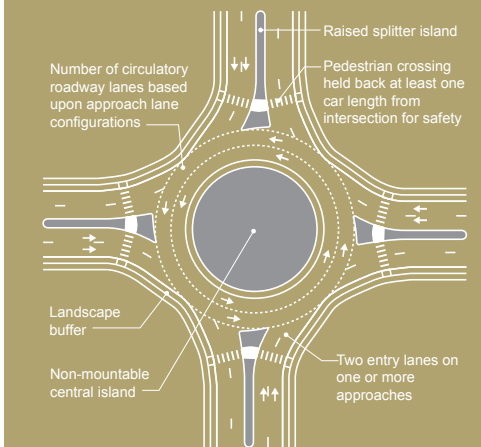

NCHRP 672 Roundabouts: An Informational Guide, Second Edition
 Transportation Research Board
 Washington, D.C.
 2010

Agronomy Road

(between Raymond Stotzer Pkwy. and F and B Road)

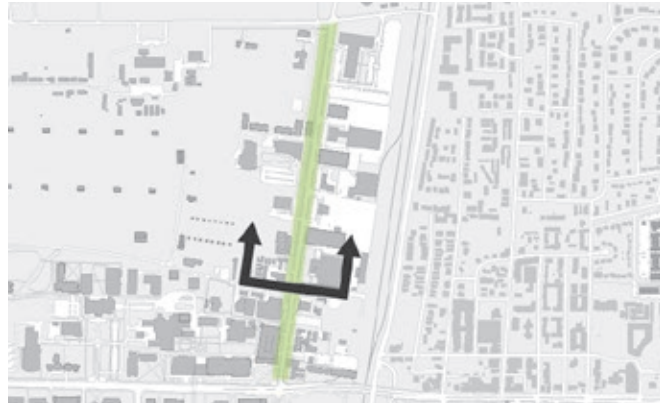

Section Location



Existing Condition

Proposed Changes

- Vehicle lanes narrowed
- Remove the sharrow in both directions
- Support pedestrians and cyclists by adding a shared use path on the east side of the road



Mobility Systems

- Roadway
- Multi-use Path (Cyclists and Peds)
- Bicycle Lane or Route
- ▨ Bicycle Lane Buffer
- Pedestrian Mall
- Vegetative Buffer
- Sidewalk (Ped Only)

Location of existing condition photograph relative to proposed section may differ slightly, due to site constraints

Asbury Street

(between Ross Street and University Drive)



Section Location



Existing Condition

Proposed Changes

- Remove angled parking
- Widen vehicle lanes and turn radii to accommodate campus transit and service vehicles
- Remove the bicycle lane and add a shared use/parallel path on the east side of the street

Mobility Systems

- Roadway
- Multi-use Path (Cyclists and Peds)
- Bicycle Lane or Route
- ▨ Bicycle Lane Buffer
- Pedestrian Mall
- Vegetative Buffer
- Sidewalk (Ped Only)



Location of existing condition photograph relative to proposed section may differ slightly, due to site constraints

Bizzell Street

(between University Drive and Ross Street)

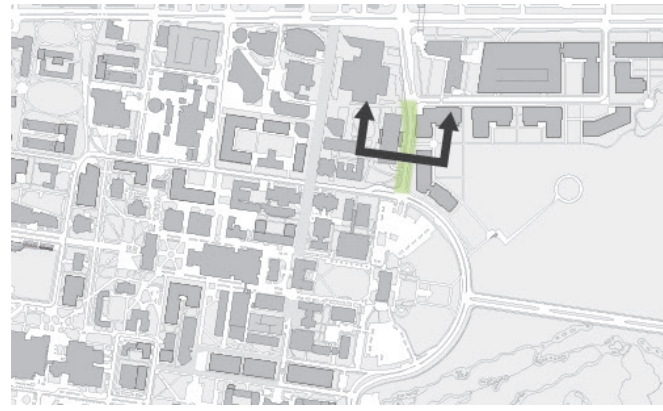

Section Location

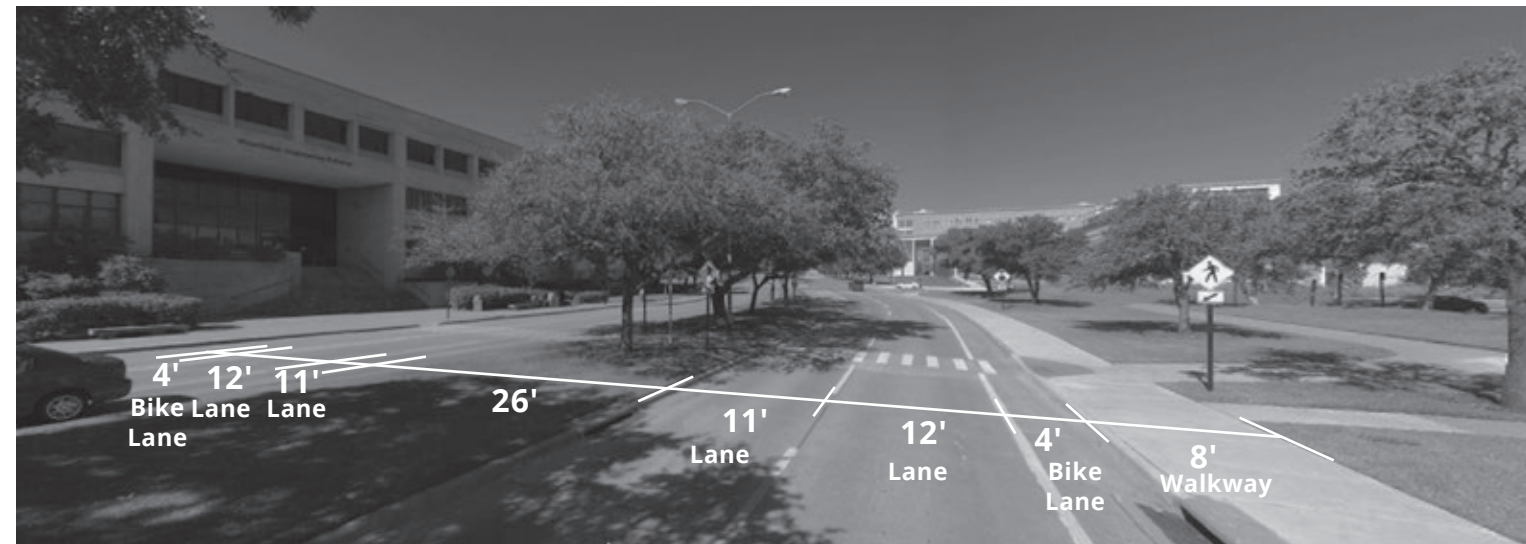

Existing Condition

Proposed Changes

- Remove median
- Reduce from four vehicle lanes to two (one in each direction)
- Add buffered bicycle lane on east side of street

Mobility Systems

- Roadway
- Multi-use Path (Cyclists and Peds)
- Bicycle Lane or Route
- ▨ Bicycle Lane Buffer
- Pedestrian Mall
- Vegetative Buffer
- Sidewalk (Ped Only)



Location of existing condition photograph relative to proposed section may differ slightly, due to site constraints

Houston Street

(between Jones Street and W. Lamar Street)



Section Location



Existing Condition

Proposed Changes

- Resize transit and vehicle lanes to support bus-only lane and passing lane
- Add bidirectional bicycle lanes
- Separate pedestrian paths
- New landscaping and transit shelters

Mobility Systems

- Roadway
- Multi-use Path (Cyclists and Peds)
- Bicycle Lane or Route
- ▨ Bicycle Lane Buffer
- Pedestrian Mall
- Vegetative Buffer
- Sidewalk (Ped Only)

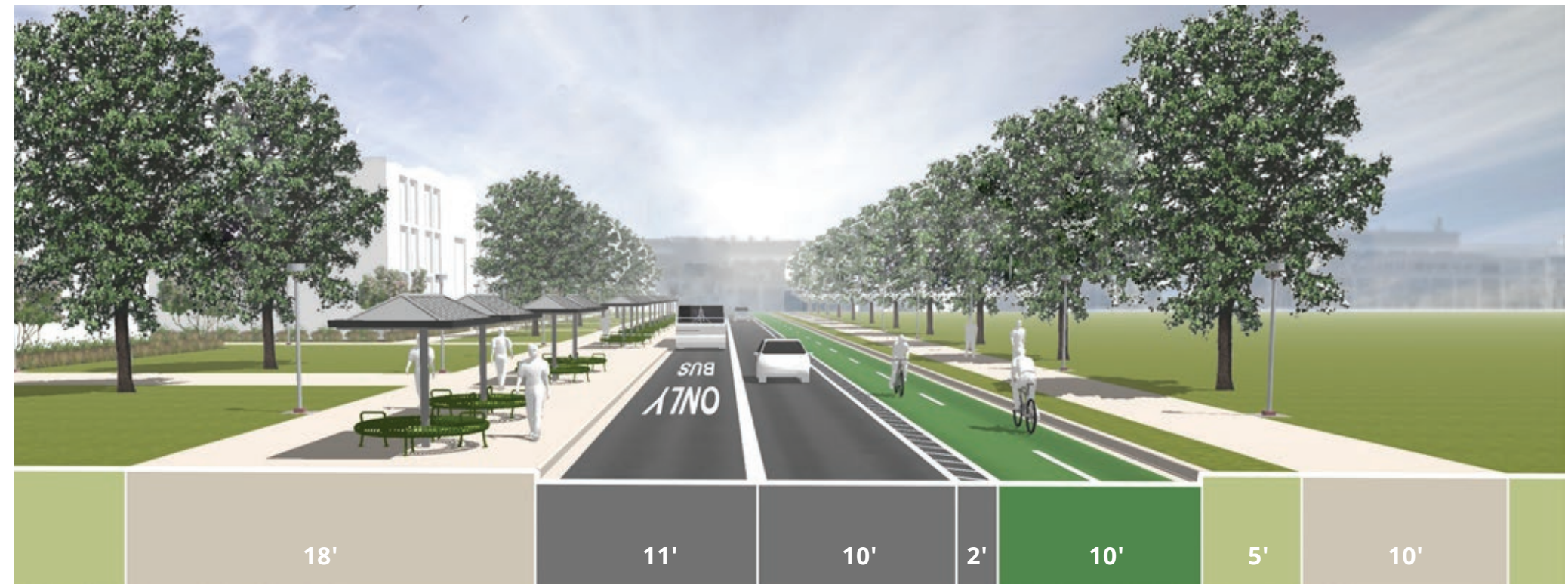

Location of existing condition photograph relative to proposed section may differ slightly, due to site constraints

Houston Street

(at Hogg Street, between Ross Street and University Drive)



Section Location

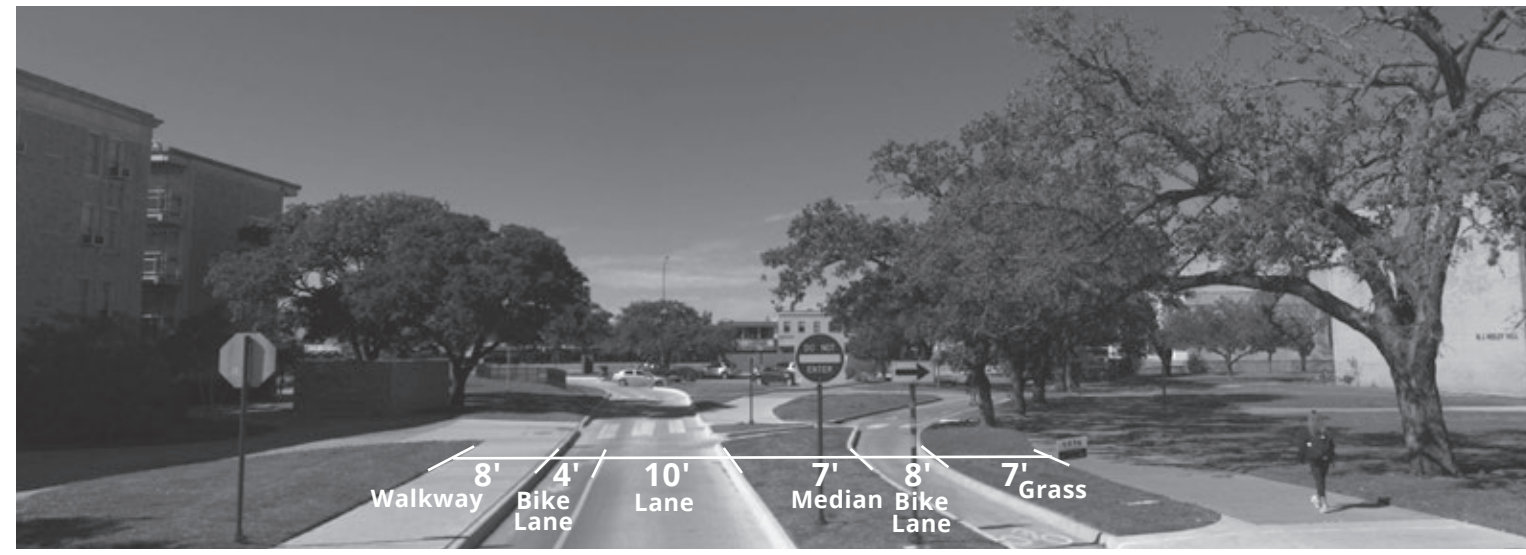

Existing Condition

Proposed Changes

- Convert vehicle lane to bicycle lane
- Widen bicycle lanes and remove raised vegetated median to be replaced with bicycle lanes in between sidewalks

Mobility Systems

- Roadway
- Multi-use Path (Cyclists and Peds)
- Bicycle Lane or Route
- ▨ Bicycle Lane Buffer
- Pedestrian Mall
- Vegetative Buffer
- Sidewalk (Ped Only)



Location of existing condition photograph relative to proposed section may differ slightly, due to site constraints

Houston Street

(at Post Office, between Ross Street and University Drive)



Section Location



Existing Condition

Proposed Changes

- Reorient post office parking lot farther west and parallel to University Drive to avoid obstructing bicycle path
- New sidewalk/green space
- Bicycle path remains as is
- Convert vehicle lane to bicycle lane

Mobility Systems

- Roadway
- Multi-use Path (Cyclists and Peds)
- Bicycle Lane or Route
- ▨ Bicycle Lane Buffer
- Pedestrian Mall
- Vegetative Buffer
- Sidewalk (Ped Only)

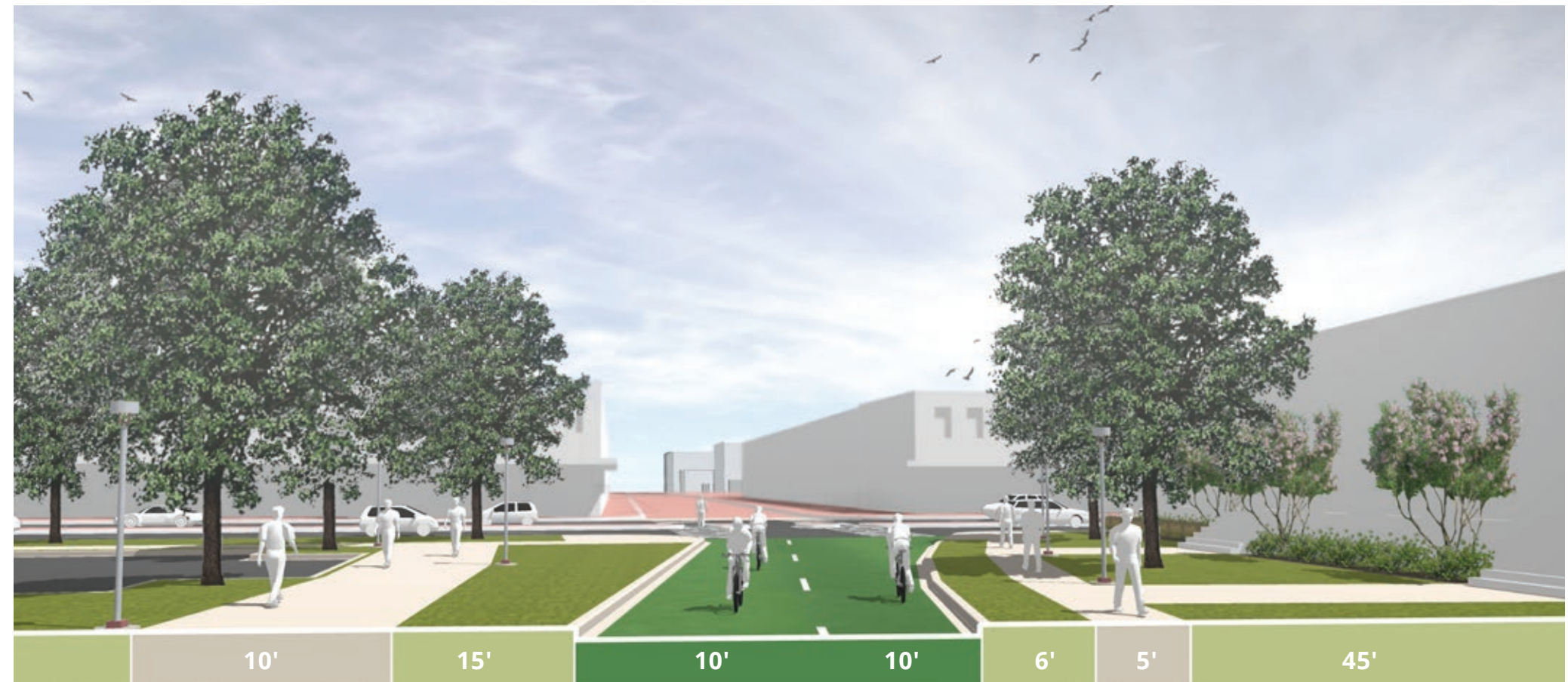

Location of existing condition photograph relative to proposed section may differ slightly, due to site constraints

Ireland Street

(between Ross Street and University Drive)



Section Location



Existing Condition

Proposed Changes

- Add a marked buffer between the vehicle and bicycle lanes
- Reduce the width of the vehicle lanes



Mobility Systems

- Roadway
- Multi-use Path (Cyclists and Peds)
- Bicycle Lane or Route
- Bicycle Lane Buffer
- Pedestrian Mall
- Vegetative Buffer
- Sidewalk (Ped Only)

Location of existing condition photograph relative to proposed section may differ slightly, due to site constraints

Kimbrough Boulevard

(between Wellborn Road and Discovery Drive)

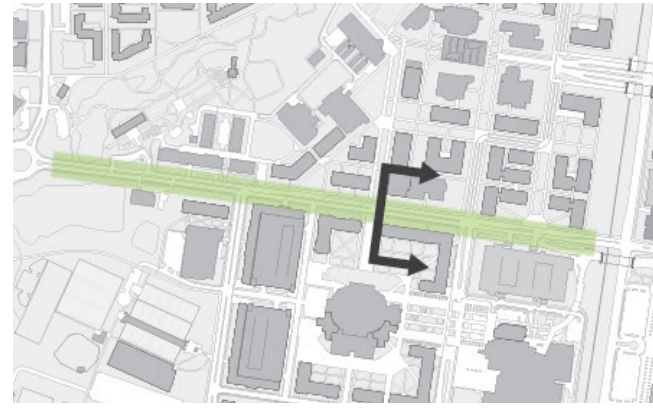

Section Location

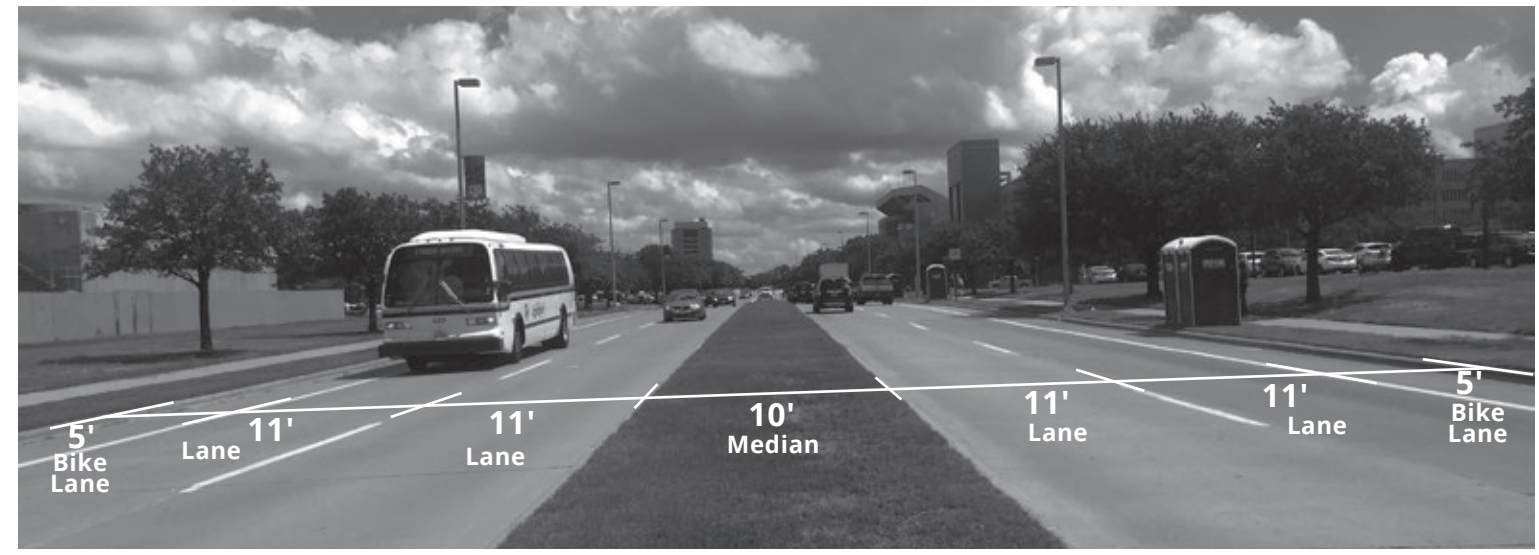

Existing Condition

Proposed Changes

- Add a shared use path on both sides of road
- Improve median landscaping
- Separate pedestrian paths
- Vehicle lanes narrowed

Mobility Systems

-  Roadway
-  Multi-use Path (Cyclists and Peds)
-  Bicycle Lane or Route
-  Bicycle Lane Buffer
-  Pedestrian Mall
-  Vegetative Buffer
-  Sidewalk (Ped Only)

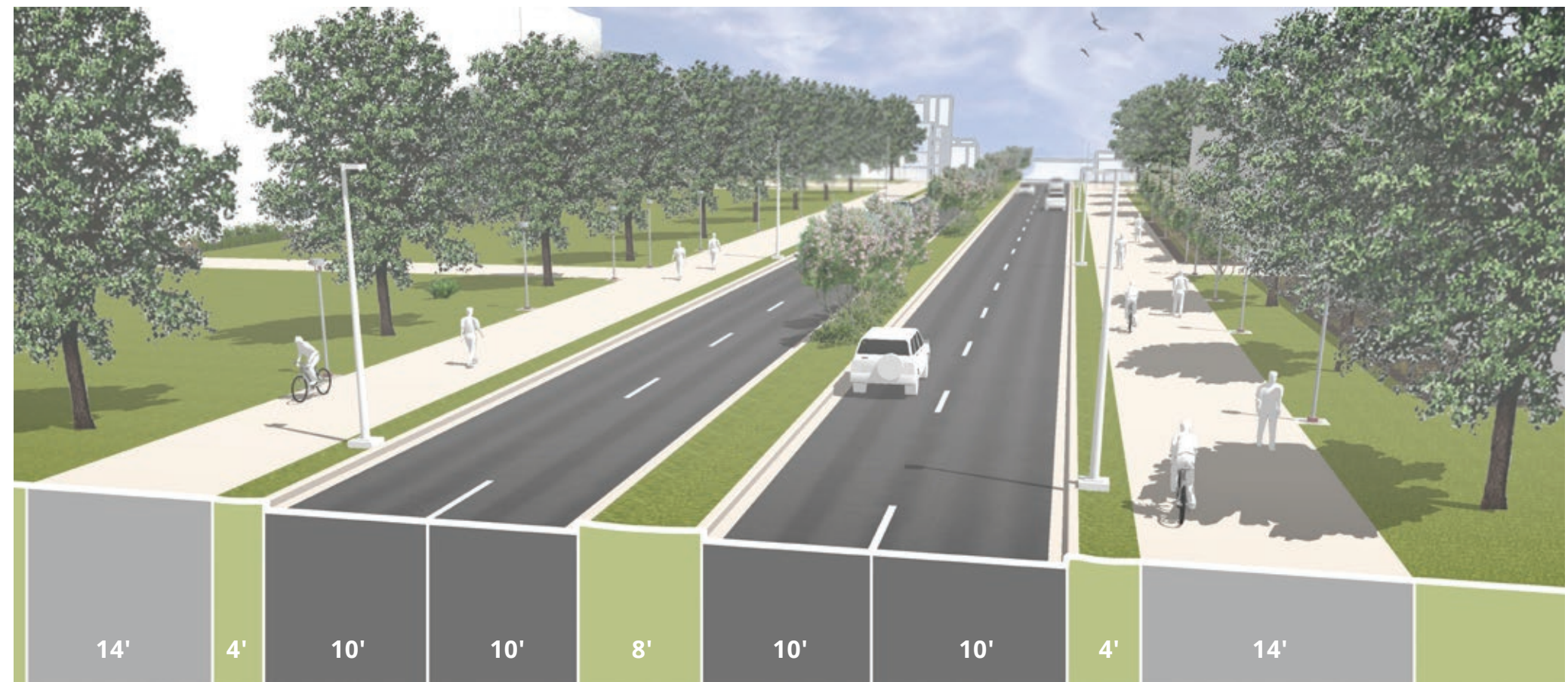

Location of existing condition photograph relative to proposed section may differ slightly, due to site constraints

Lamar Street (Nagle St. similar)
(between Spence Street and Nagle Street)



Section Location

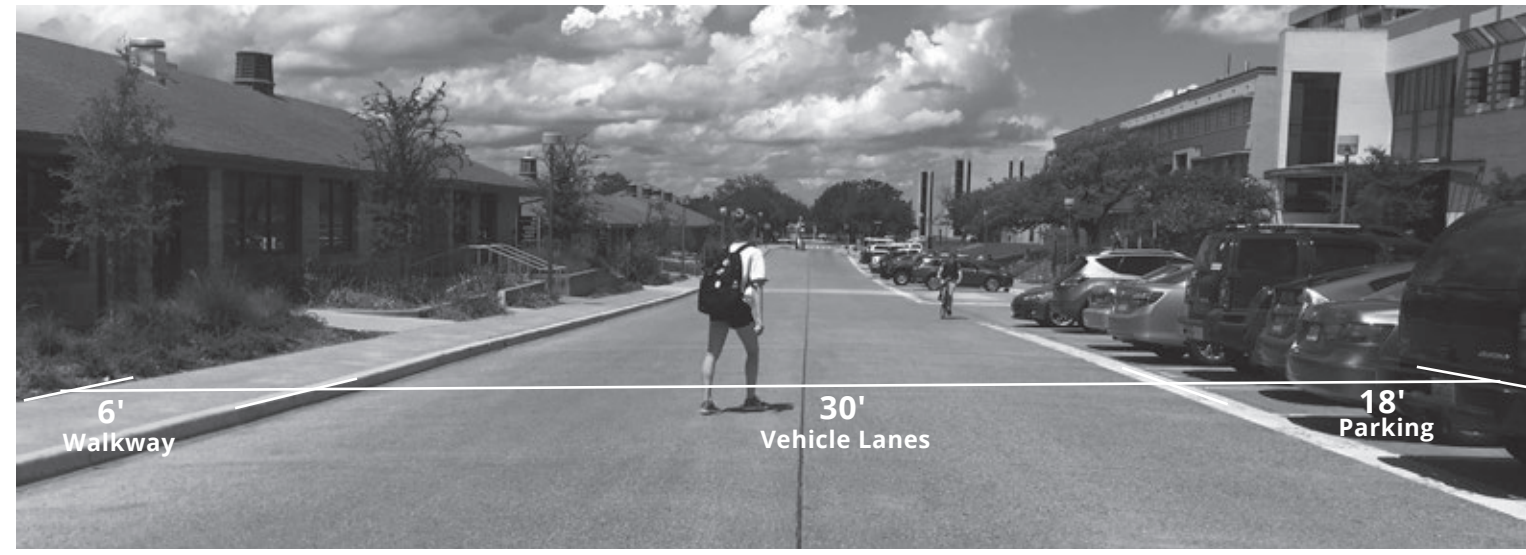

Existing Condition

Proposed Changes

- Remove vehicle lanes and parking
- Add pedestrian plaza
- Maintain access route for game day

Mobility Systems

- Roadway
- Multi-use Path (Cyclists and Peds)
- Bicycle Lane or Route
- Bicycle Lane Buffer
- Pedestrian Mall
- Vegetative Buffer
- Sidewalk (Ped Only)



Location of existing condition photograph relative to proposed section may differ slightly, due to site constraints

W. Lamar Street

(between Gene Stallings Boulevard and Houston Street)

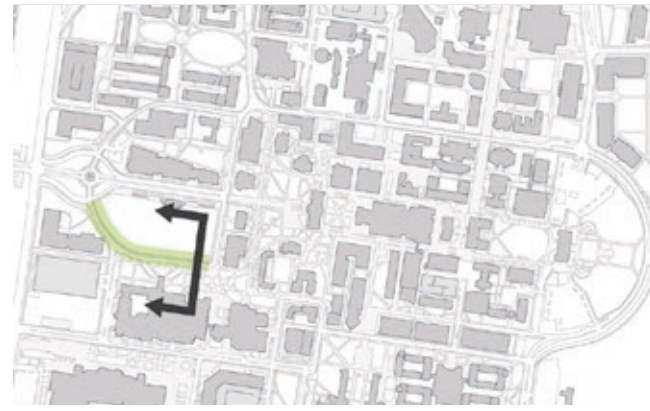

Section Location

Existing Condition

Note: Converting W. Lamar Street to limited access will require study to determine best strategy for providing continued access to disabled parking at MSC north entrance.

Proposed Changes

- Remove parking lane along Simpson Drill Field
- Convert to transit and service vehicles only
- Add buffered bidirectional bicycle lane along north side of street

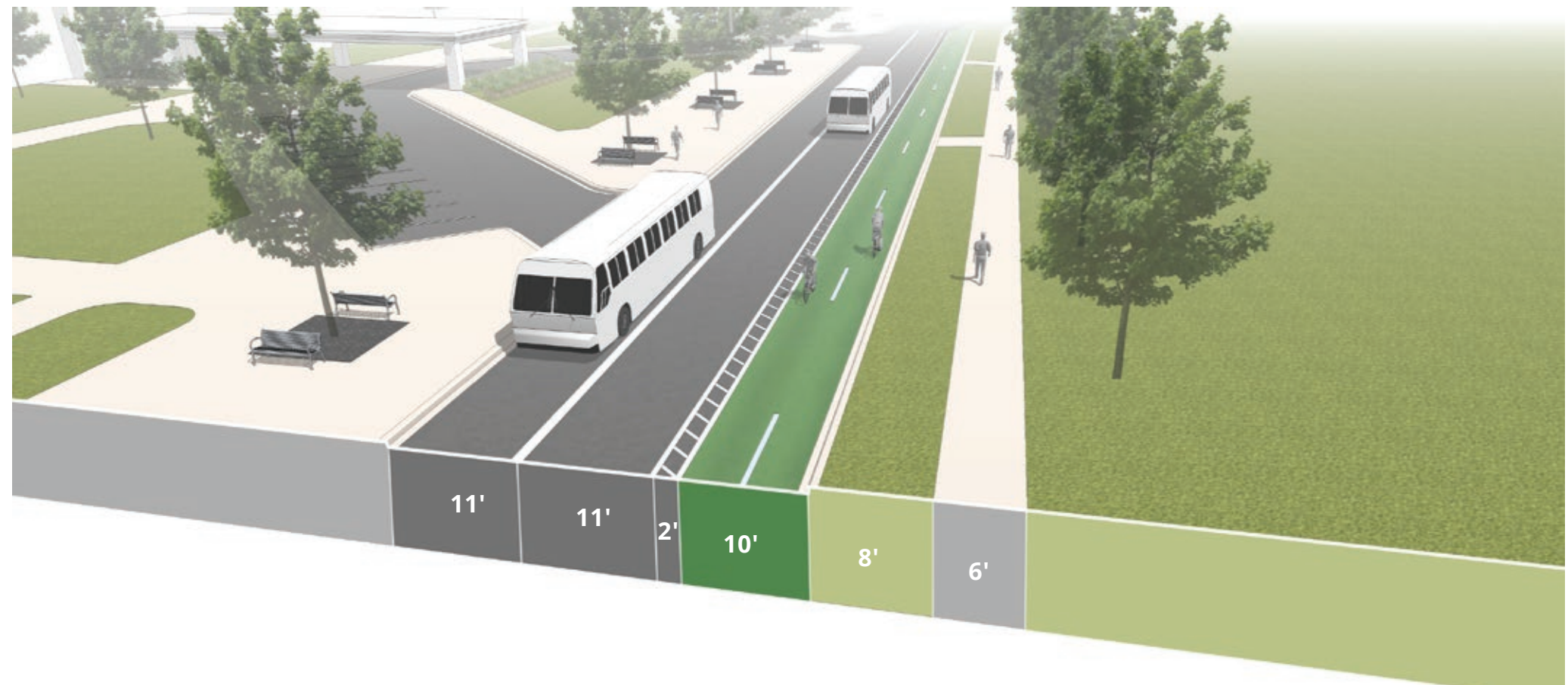

Mobility Systems

- Roadway
- Multi-use Path (Cyclists and Peds)
- Bicycle Lane or Route
- ▨ Bicycle Lane Buffer
- Pedestrian Mall
- Vegetative Buffer
- Sidewalk (Ped Only)

Location of existing condition photograph relative to proposed section may differ slightly, due to site constraints

Lewis Street

(between Bizzell Street and Coke Street)



Section Location



Existing Condition

Proposed Changes

- Convert roadway to pedestrian mall between Duncan and garage entrance drives
- Narrow Duncan and garage access roadways to 2 lanes with no median
- Shared use path on south side of street at remaining roadways
- Buffered bicycle lane and sidewalk on north side of street at remaining roadway
- Improved and screened loading areas for Duncan Dining Hall

Mobility Systems

- Roadway
- Multi-use Path (Cyclists and Peds)
- Bicycle Lane or Route
- ▨ Bicycle Lane Buffer
- Pedestrian Mall
- Vegetative Buffer
- Sidewalk (Ped Only)



45'

Location of existing condition photograph relative to proposed section may differ slightly, due to site constraints

Lubbock Street

(between Coke Street and Spence Street)



Section Location



Existing Condition

Proposed Changes

- Convert vehicle lanes to sharrows
- Maintain sidewalks on both sides
- Add raised vegetative buffer on the south side of the street between the travel lane and the sidewalk
- Vehicle lanes narrowed

Mobility Systems

- Roadway
- Multi-use Path (Cyclists and Peds)
- Bicycle Lane or Route
- ▨ Bicycle Lane Buffer
- Pedestrian Mall
- Vegetative Buffer
- Sidewalk (Ped Only)



Location of existing condition photograph relative to proposed section may differ slightly, due to site constraints

Spence Street

(between University Drive and East Quad)

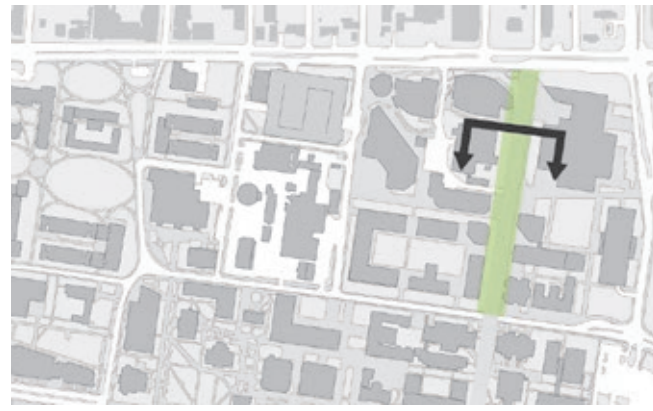

Section Location

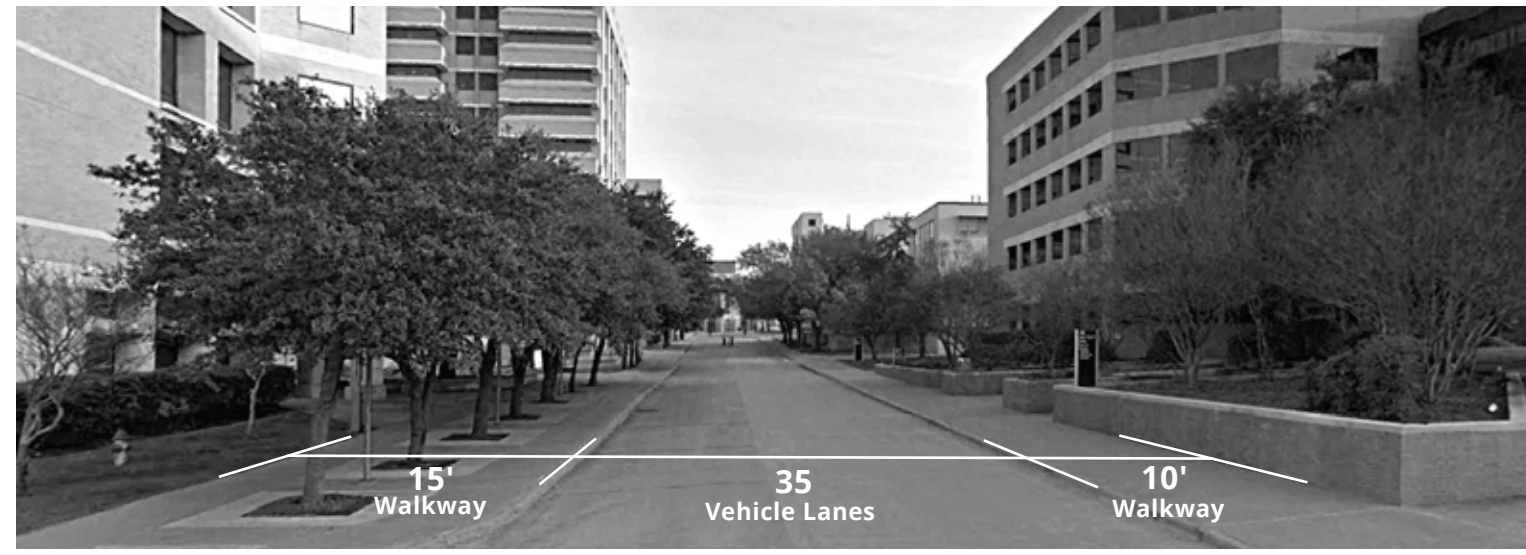

Existing Condition

Proposed Changes

- Remove vehicle lanes and parking
- Add pedestrian plaza
- Maintain access route for food trucks, service, and emergency vehicles
- Add tree plantings

Mobility Systems

- Roadway
- Multi-use Path (Cyclists and Peds)
- Bicycle Lane or Route
- ▨ Bicycle Lane Buffer
- Pedestrian Mall
- Vegetative Buffer
- Sidewalk (Ped Only)

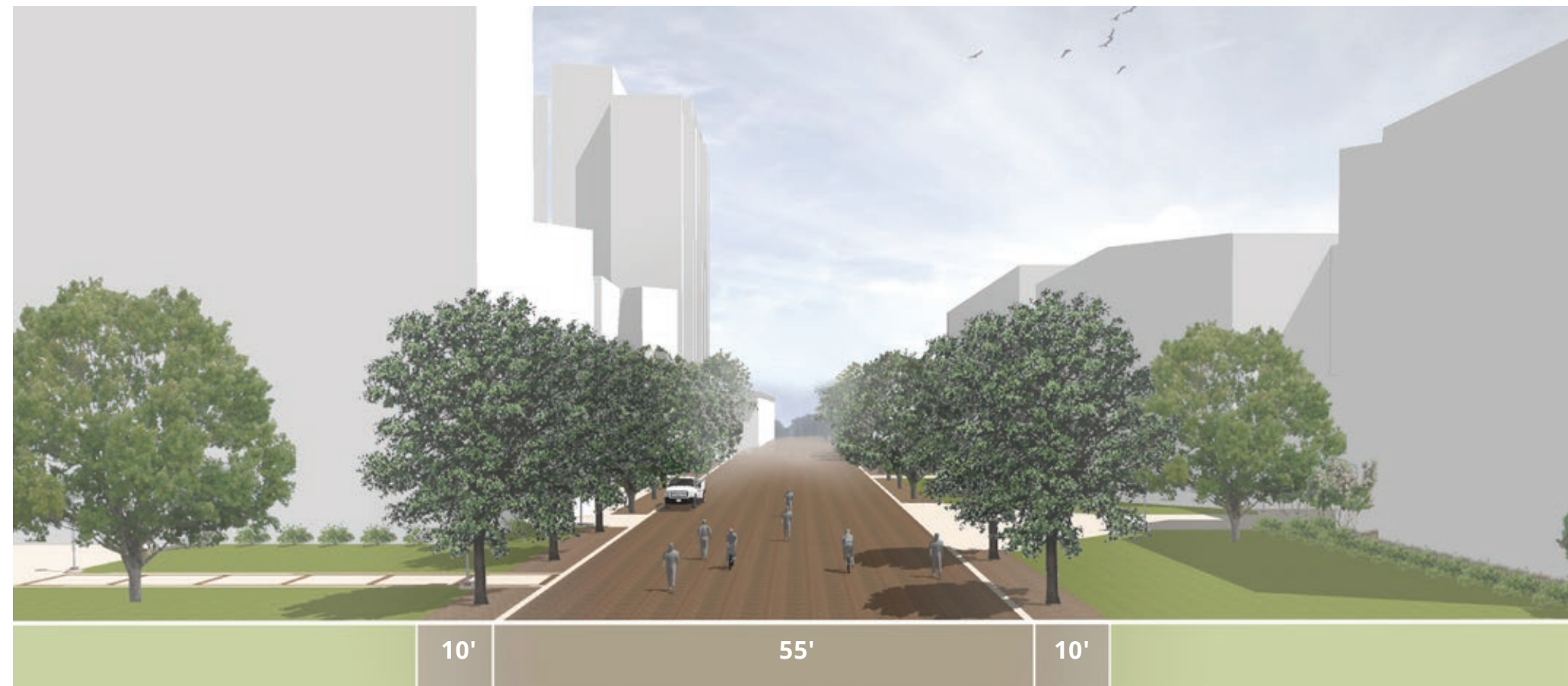

Location of existing condition photograph relative to proposed section may differ slightly, due to site constraints

Olsen Boulevard

(between Stotzer Pkwy. and Kimbrough Boulevard)



Section Location

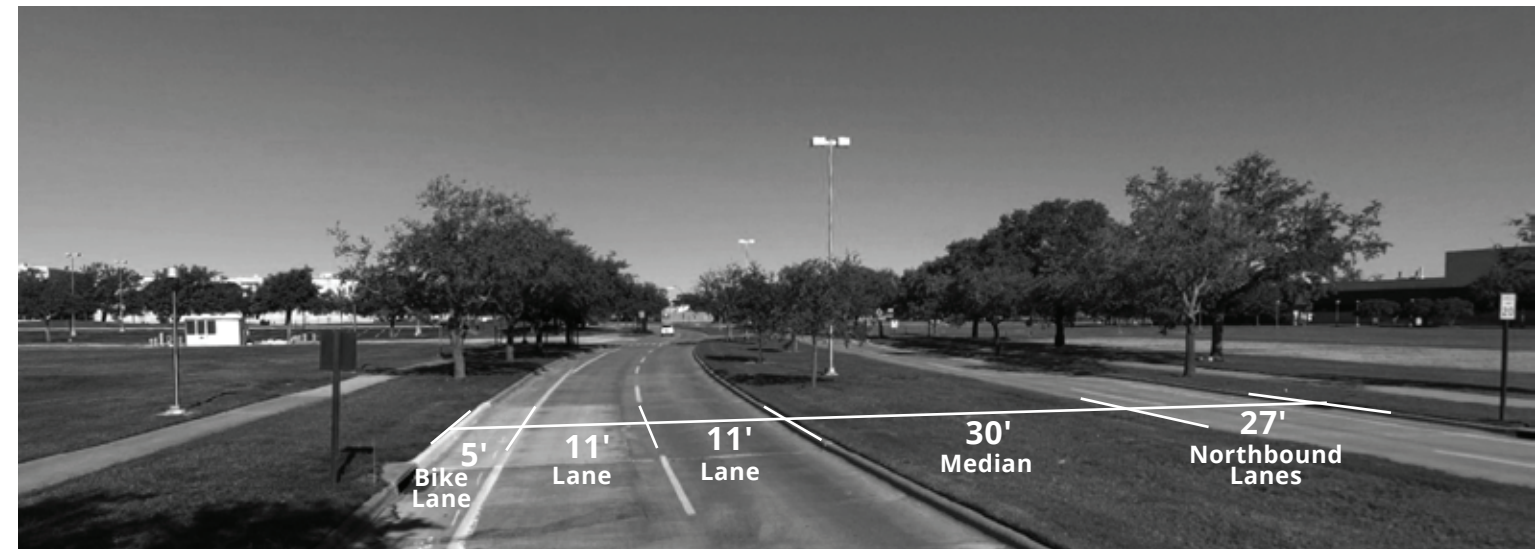

Existing Condition

Proposed Changes

- Shared use path on both sides of the road
- Reduce from four travel lanes to two travel lanes (one in each direction)
- Vehicle lanes narrowed

Mobility Systems

-  Roadway
-  Multi-use Path (Cyclists and Peds)
-  Bicycle Lane or Route
-  Bicycle Lane Buffer
-  Pedestrian Mall
-  Vegetative Buffer
-  Sidewalk (Ped Only)



Location of existing condition photograph relative to proposed section may differ slightly, due to site constraints

Olsen Boulevard

(between George Bush Drive and Kimbrough Boulevard)



Section Location



Existing Condition

Proposed Changes

- Reduce width of raised vegetated buffer on both sides of the road
- Add buffered bicycle lane on the east side of the road
- Add shared use path on the west side of the road
- Left turn lane narrowed

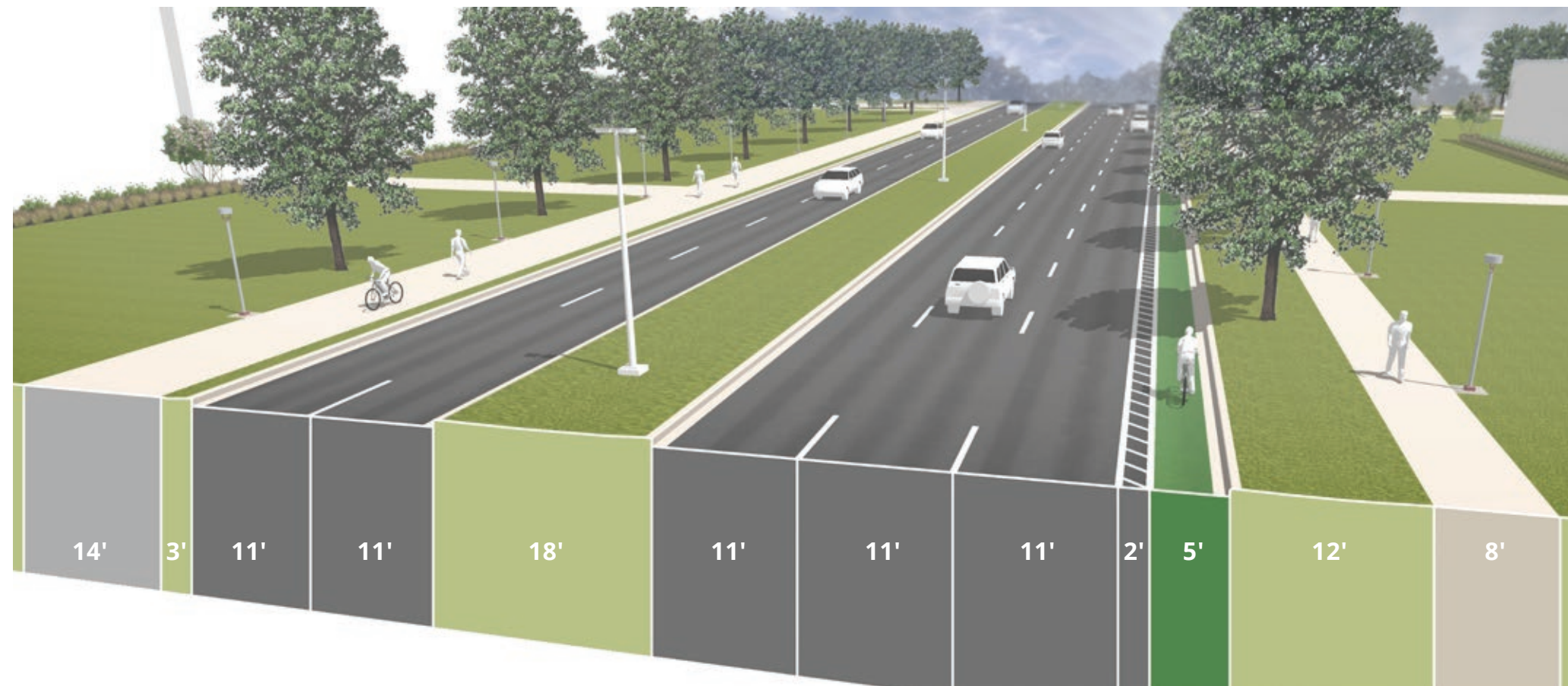

Mobility Systems

- Roadway
- Multi-use Path (Cyclists and Peds)
- Bicycle Lane or Route
- Bicycle Lane Buffer
- Pedestrian Mall
- Vegetative Buffer
- Sidewalk (Ped Only)

Location of existing condition photograph relative to proposed section may differ slightly, due to site constraints

Wellborn Road

(between George Bush Drive and University Drive)



Section Location



Existing Condition

Proposed Changes

- Add shared use path on east side of Wellborn by reducing width of grass area on west side of the road
- Vehicle lanes narrowed
- Changes to Wellborn Rd. will require coordination with Texas Department of Transportation

Mobility Systems

-  Roadway
-  Multi-use Path (Cyclists and Peds)
-  Bicycle Lane or Route
-  Bicycle Lane Buffer
-  Pedestrian Mall
-  Vegetative Buffer
-  Sidewalk (Ped Only)

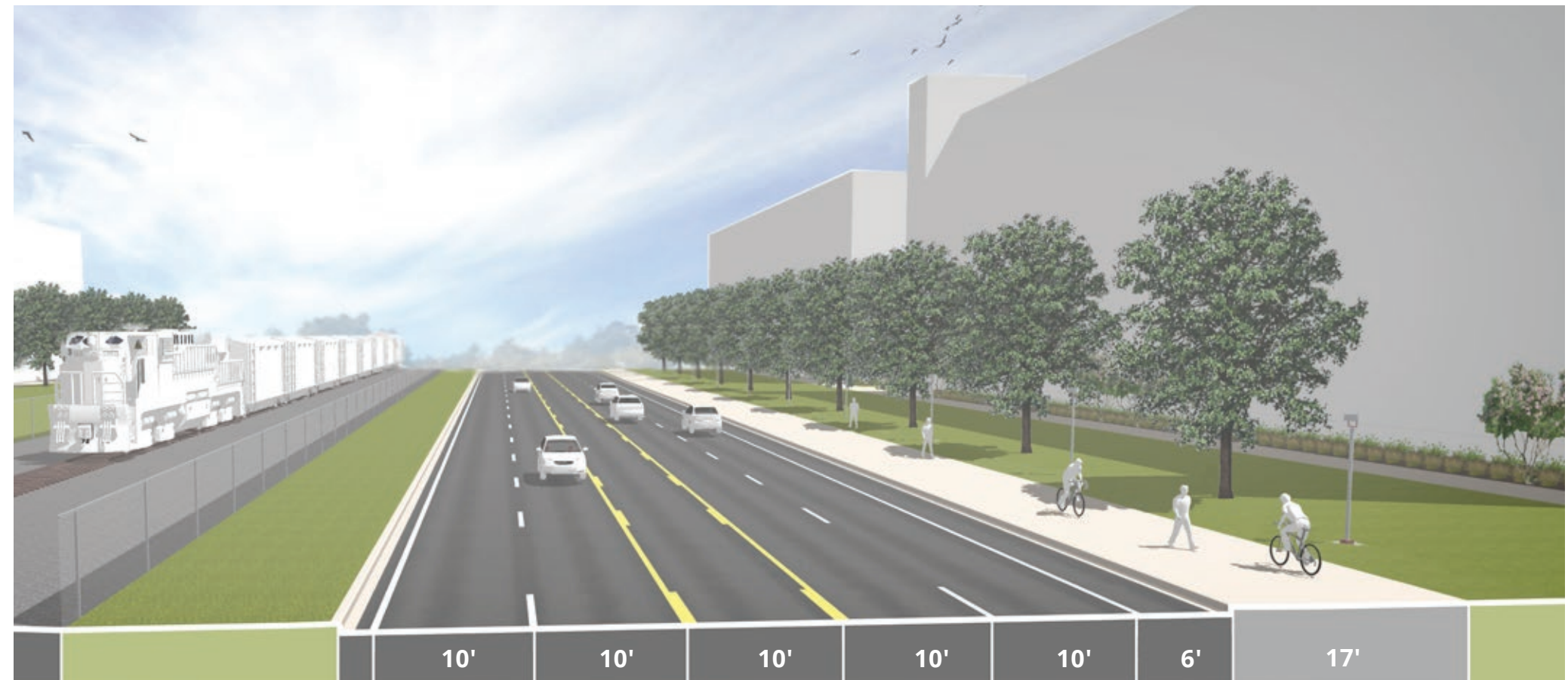

Location of existing condition photograph relative to proposed section may differ slightly, due to site constraints

Proposed Parking Alterations

Perimeter parking affords numerous safety, land use, and environmental benefits to campus. Surface lot removal will reduce vehicle, pedestrian, and bicycle conflicts by encouraging vehicles to park before entering the dense, heavily populated campus core. Parking removed from the core of campus will be replaced in parking structures near the campus periphery. The new Parking structures should provide transition points for transportation mode changes via adjacent transit stops and bicycle parking. Perimeter parking allows Texas A&M to make the highest, best use of its land area, replacing former parking areas with greenspace or building sites, and promotes social engagement across the campus. Parking Structures also provide more spaces while creating less stormwater runoff compared to surface lots. New Parking Structures are sited to relieve current parking demands (including east of Bizzell Street and Reed Arena), and to support new development in the West Campus and Research Park.

Two alternate sites are presented, west of the Veterinary Medicine Building, and east of Bizzell Street by the golf course. The site by Veterinary Medicine may better serve the population of that complex, but does not as effectively serve the area along Agronomy Road. The alternate along Bizzell Street would serve the proposed development adjacent to the golf course, and may be needed if site constraints limit the size of the proposed garage south of Lewis Street.

Depending on the pattern of future development, multiple smaller garages may be more suitable, rather than fewer large ones as shown. Smaller, more numerous garages would allow the University to more easily build parking as needed and would disperse vehicles over a wider area, avoiding the congestion sometimes experienced in large garages. Regardless of size, however, garage locations should maintain a five-minute walking radius to all campus destinations. Because garage size and location have long-term impacts on future development and circulation patterns, the siting, design, and phasing of each need to be carefully considered, placing value on the need to maintain flexibility in future planning.





Character Zone	Existing Spaces	Removed (Surface Lot)	Added (Parking Structure)	Total New Parking	% Difference
Northside	3,532	690	1,040	3,882	9%
Historic Core	3,265	614	-	2,651	-23%
Southside	3,398	1,345	1,517	3,570	5%
Campus Front	2,262	2,262	2,854	2,854	21%
Athletics and Rec.	7,351	2,651	3,726	8,426	13%
West Campus	4,913	4,913	3,045	3,045	-61%
Research Park	3,276	649	3,420	6,047	46%
Hensel	835	94	-	835	0%
Univ./Agron.	4,005	991	1,200	4,214	5%
F&B Rd.	414	-	200	614	33%
Health Sciences	1,125	1,125	4,246	4,246	74%
Golf Course	142	-	-	142	0%
Bush	554	-	-	554	0%
Total	35,072	15,334	21,248	41,080	15% increase

Parking Counts as per Campus Master Plan Recommendations



Proposed Parking Structures at Reed Arena

Proposed Parking Alterations

-  Parking to Remain
-  Parking to be Removed
-  Existing Parking Structure
-  Proposed Parking Structure
-  Proposed Parking Structures - Alternate Location



The locations and access specified in the Campus Master Plan are suggestions only and should be studied in detail as development occurs. As each garage is more closely studied prior to its construction, the access points and driveway designs must be considered. The number of access points for parking structures are determined by analysis including peak hours volume (quantity) of vehicles entering and exiting, identifying primary users, and what facilities and activities the garage most directly supports. The driveway design must determine such factors as the number of lanes, ease of entry, capacity of connecting streets, and type of controlled gate access.

The ideal number of parking spaces to plan for campus is difficult to determine due to the variety of campus activities, from daily academic uses to large sporting and assembly events, and due to changes in technology and driving habits. The Institute of Transportation Engineers (ITE) suggests using a ratio of 0.38 vehicles/student population on a college campus, but Kyle Field and other large assembly spaces require a larger number of spaces on campus than this ratio would suggest. ITE does not publish parking standards specifically for large sports venues because requirements fluctuate based on location, surrounding uses, and public transportation opportunities.

Given the 0.38 ITE ratio, and knowing campus's large venues require more parking be intermittently available to support events, the Campus Master Plan concludes that the current ratio of 0.64 vehicles/student is adequate. To accommodate increased enrollment planned within the next 20 years and maintain the existing parking ratio, a net parking space gain of approximately 15% will be needed as interior small surface lots are relocated into perimeter garages.

Accessible parking should still be accommodated in lots within or close to the core of campus. These spaces should be accessible only by permit holders. Accessible parking replacement may require more detailed study.





The University may wish to consider a joint study with the cities of Bryan and College Station to explore the potential of off-campus satellite parking facilities located on existing transit routes, or served by dedicated shuttles.



Existing and Suggested Parking Structure Locations

- Suggested Parking Garage
- Existing Parking Garage
- 5-Minute Walk Radius
- Suggested Parking Garage - Alternate Location

Proposed Parking Alterations

-  Parking to Remain
-  Existing Parking Structure
-  Proposed Parking Structure
-  Proposed Parking Structures - Alternate Location

Harvey Mitchell Pkwy.
(FM 2818)

Stotzer Pkwy. (FM 60)

University Dr. (FM 60)

Bizzell St.

Wellborn Rd. (FM 2154)

George Bush Dr. (FM 2347)

Texas Ave. (BS 6)



Multi-Modal Systems

It is critical to harmonize the modes of transportation to, within, and across campus. The best mobility system is one that aligns with people's inclinations while providing clear and authoritative guidance and incentives. The various components of the campus mobility network – pedestrian paths, bicycle paths, transit routes, road and parking alterations, and proposed garage locations – integrate into a coordinated, comprehensive strategy that supports the Pedestrian-Priority Zone and improves the quality of campus life while maximizing efficient movement.

The mobility network strategy of this Campus Master Plan relies on travelers to campus leaving their cars at perimeter garages and moving into the heart of campus via the network of bicycle and pedestrian paths or transit options connected directly to the garages. Strategies to limit the number of vehicles brought to campus are also included, among them: support for bicycle use via self-maintenance facilities and secured, covered parking at the garages, transit stops coordinated with new parking garages to support travelers' quick and easy transition between cars and buses, and bicycle rack installation on campus buses, particularly those serving off-campus routes.

These strategies will enable campus users to bicycle to off-campus transit stops (extending the effective coverage radius of existing routes), ride to campus, then continue biking within campus all without driving a vehicle. Additional on-campus circulators, such as shuttle vans or jitneys, could provide quick-turnaround service to specific garages, providing further convenience while keeping on-campus traffic to a minimum. Planned and proposed grade separations along George Bush Drive and University Drive will supplement the popular existing separations at Wellborn Road, increasing opportunities for safe access to campus by pedestrians and cyclists.

Outside the Pedestrian-Priority Zone, many facility-specific surface parking lots will be retained to reduce the need for garages until development requires them. These lots will continue to provide convenient access to areas of low pedestrian-vehicle interaction.



Pedestrian, Bicycle and Bus Systems Working Simultaneously



Daily Transportation Interactions at Texas A&M

Proposed Mobility Network

- Roadways (Unlimited Access)
- ⋯ Roadways (Limited)
- Transit Routes
- Dismount Zone
- Bicycle Routes
- ⌘ Grade Separation
- Surface Parking Lot
- Existing Parking Structure
- Proposed Parking Structure
- ⌘ Proposed Parking Structures - Alternate Location
- ◆ Scheduled Transit Stop
- Demand Transit Stop

Harvey Mitchell Pkwy.
(FM 2818)

Stotzer Pkwy. (FM 60)

University Dr. (FM 60)

Wellborn Rd. (FM 2154)

George Bush Dr. (FM 2347)

Texas Ave. (BS 6)

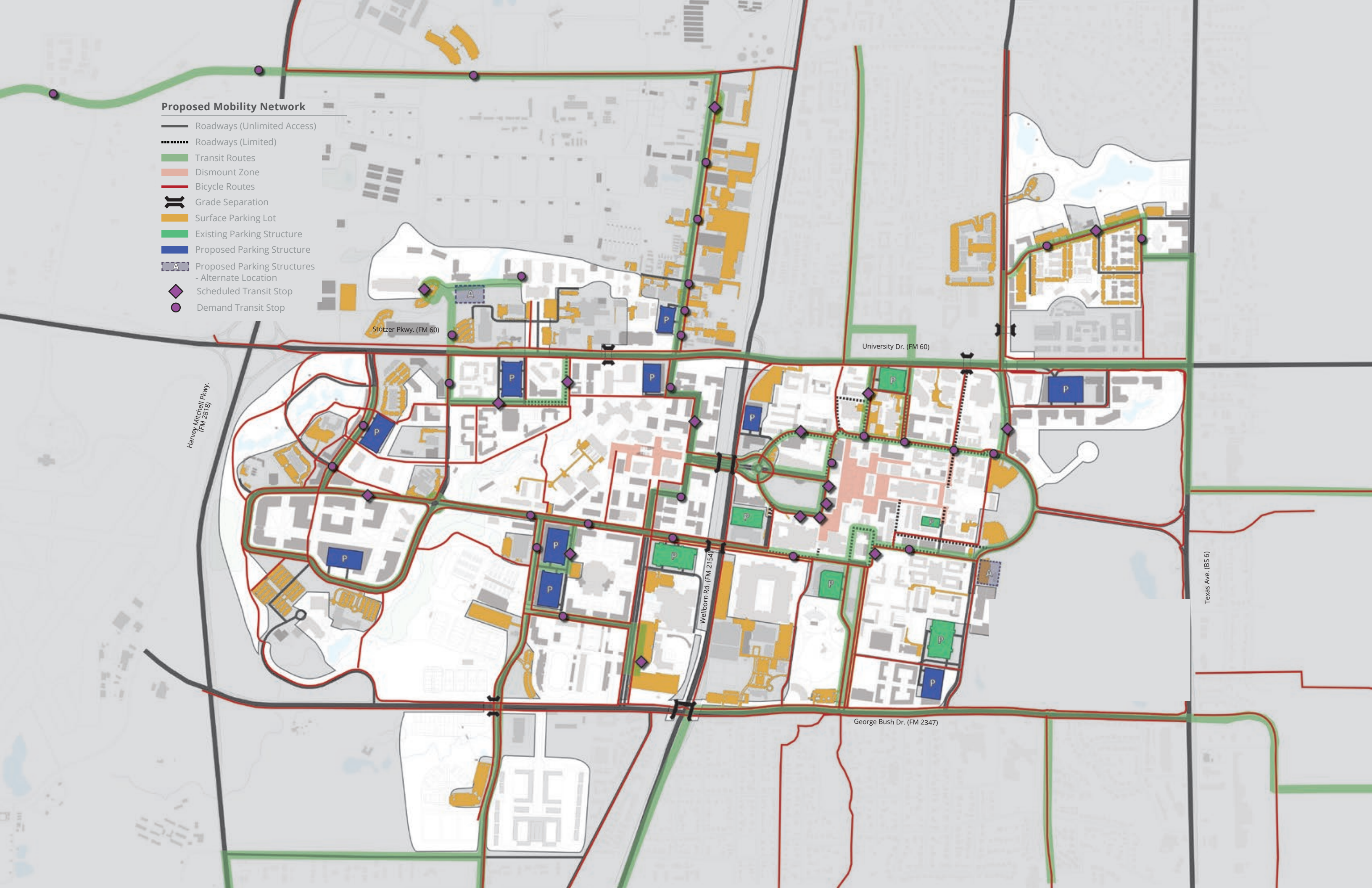

GAME DAY CIRCULATION

Major event and athletic game days are the most extreme mobility challenges faced by Texas A&M. Attendance at these events commonly numbers in the tens of thousands, and attendance at sell-out football games exceeds 100,000. The University, in cooperation with the Texas A&M Transportation Institute and City of College Station staff, has intensely studied the management of event day traffic and parking, placing particular focus on strategies for the smooth, timely entering and exiting of many thousands of cars after these events.

The Campus Master Plan has been developed with an awareness of the critical routes employed as part of the game day exit strategy. While most of the Plan's proposed road alterations occur in areas away from these routes, alterations along critical routes have been shaped to work cooperatively with the game day exit strategy.

It is anticipated that planned Texas Department of Transportation improvements along Harvey Mitchell Parkway and at the George Bush Drive-Wellborn Road intersection will significantly enhance the University's ability to rapidly move game day traffic away from campus. Grade separation of routes and modes of travel, decreased traffic signal wait times, and reduction of turn lane conflicts should expedite the flow of vehicular traffic. Multi-use paths incorporated into these projects will provide a safe means of pedestrian egress from campus, reducing pedestrian-vehicle conflicts.



Traffic Congestion during Game Day at Texas A&M University



Pedestrian Congestion during Game Day at Texas A&M University

Game Day Routes

-  Road Closures
-  Exit Routes
-  Venues
-  Existing Parking Structure
-  Proposed Parking Structure
-  Proposed Parking Structures - Alternate Location
-  Limited Access: Game Day Only



RELATED TRANSPORTATION INITIATIVES

Campus and City Integration

A recurring theme in this chapter is the need for Texas A&M and its host communities to work cooperatively to address mobility issues. The University is a major source of transportation activity in Brazos County and the region. The State of Texas, Brazos County, and the cities of Bryan and College Station recognize this and work cooperatively together, and with the Texas A&M Transportation Institute, Bryan/College Station Metropolitan Planning Organization, and other entities to adapt to the evolving traffic management complexities generated by the growing campus. The non-campus road projects highlighted here demonstrate an understanding of how traffic management challenges impact the University and surrounding communities, and a commitment to resolving those challenges. An example of this coordination is the integration of the pedestrian network into the interchanges at Stotzer and Harvey Mitchell Parkways, and at George Bush Drive and Wellborn Road.

The anticipated growth on and around campus over the next several years lends urgency to the addressing of circulation and safety issues, but also presents opportunities for solutions that can enhance community character. An important aspect of cooperative efforts is the search for ways that University-centered projects can benefit the host community. A project can more easily recruit support and reach completion if it is perceived as being an asset for all parties.

Issues that would particularly benefit from cooperative efforts include:

- Satellite parking and shuttle service to campus and other destinations
- Bicycle path network connectivity
- Safe pedestrian travel between campus and nearby housing and businesses
- Integration of public amenities like small parks, landscaping, or public art into transportation-oriented projects
- Selective widening of secondary roads around campus, for example, Luther Street between Marion Pugh Drive and Harvey Mitchell Parkway, and extending Luther Street southwest to connect to Dowling Road.

Non-Campus Road Improvements

These projects are currently in various phases of planning or execution, and are intended to resolve traffic flow challenges related to peak hour volume and exiting game day traffic, and to improve pedestrian safety and multi-use path connectivity.

1. University Drive:

Alterations are scheduled from College Main through Bizzell Street to improve pedestrian safety, including wider sidewalks and pedestrian crossings, pedestrian-only crossing phases at traffic signals, and landscape buffer plantings. The Master Plan's proposed grade separations would complement these alterations to greatly improve the pedestrian experience along University Drive. Decreased vehicle lane widths will lower vehicle speeds, and reconfigured left turn lanes will improve traffic flow.

2. George Bush Drive:

The Wellborn Road intersection will undergo major changes. New bridges will allow two through lanes in each direction on Wellborn Road to cross over a depressed George Bush Drive. Union Pacific Railroad will remain at its current level and eventually be double tracked to eliminate traffic disruptions from passing trains. The new George Bush Drive underpass will be below a pedestrian and cyclist path. This grade separation will allow travelers to cross more safely at this intersection.

3. Raymond Stotzer Parkway and Harvey Mitchell Parkway:

A planned project will reconfigure the bridge over Harvey Mitchell Parkway into a diverging diamond intersection. This concept works by eliminating opposing traffic for vehicles turning left. This alteration will reduce congestion by shortening the traffic signal cycle lengths and should especially help move game day and special event traffic. A shared-use path will connect from the southeast corner of the interchange near Research Park, across the bridge to the northwest corner at the Aggie Field of Honor.

Non-Campus Road Improvements

- Pedestrian or Multi-use Paths
- Bicycle Lane
- Pedestrian/Bicycle Bridge
- Existing Parking Structure

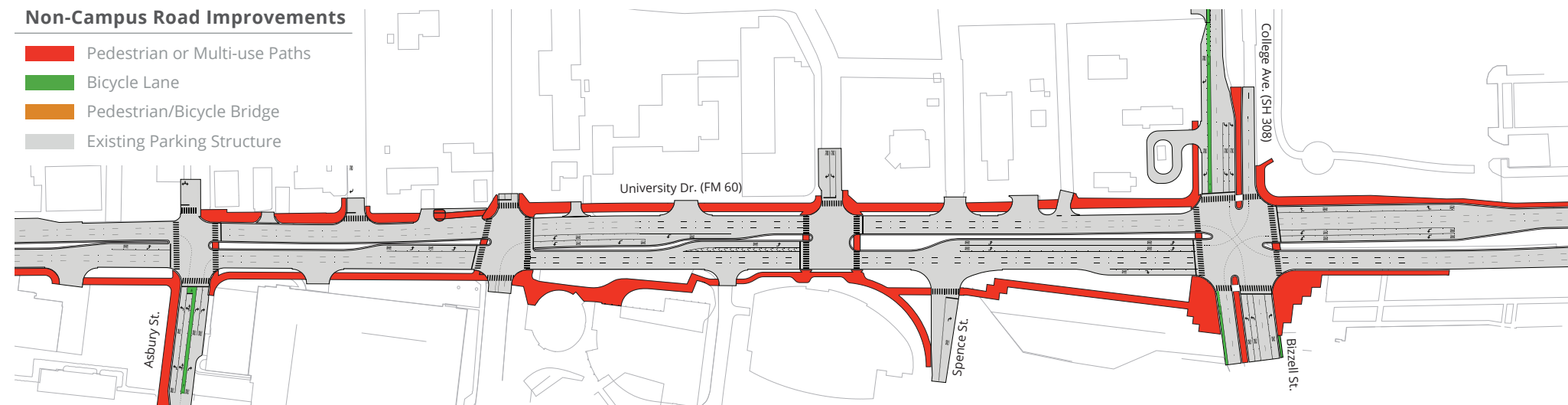

1. City of College Station Improvements along University Drive

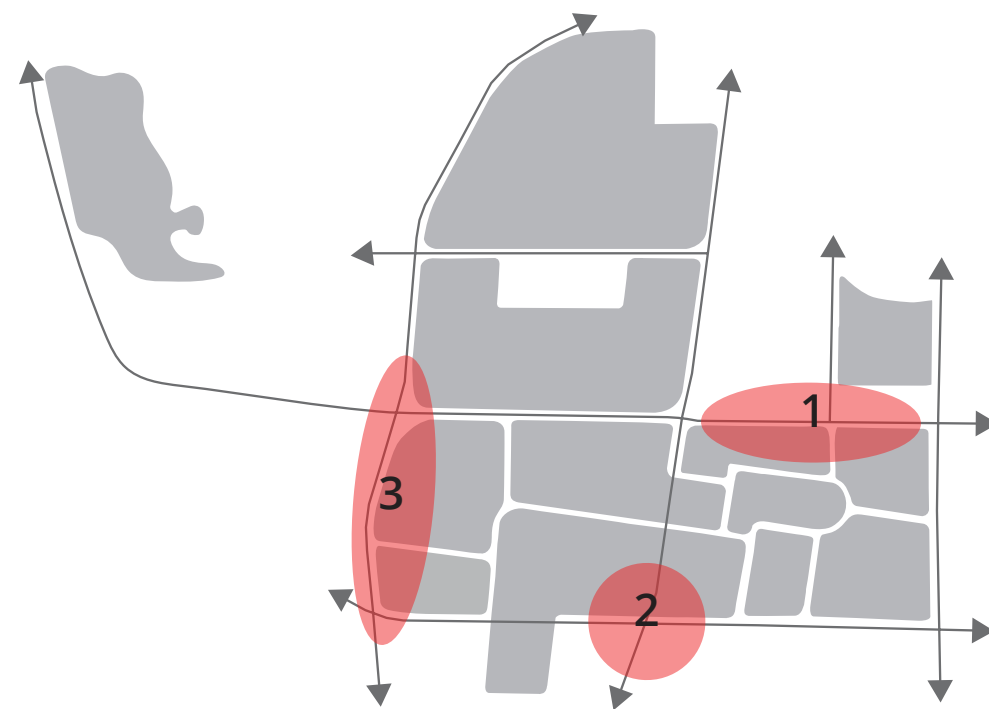

Non-Campus Road Improvement Projects Keyplan

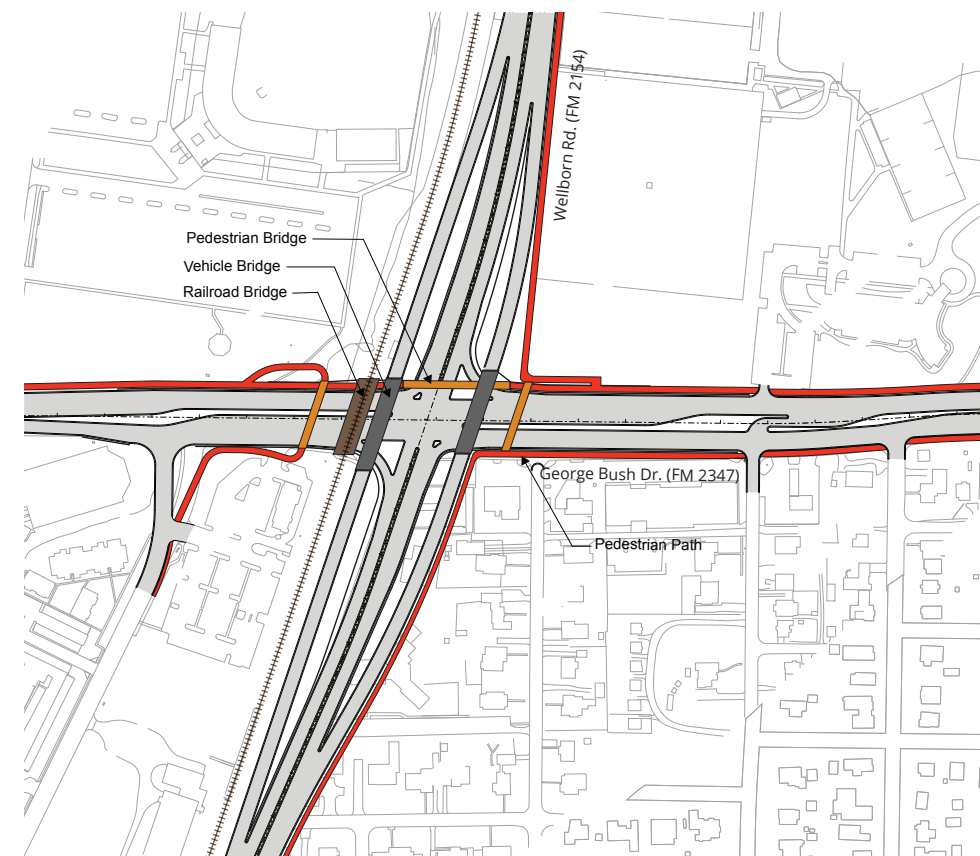

2. Texas Department of Transportation Grade Separation at George Bush Drive and Wellborn Road

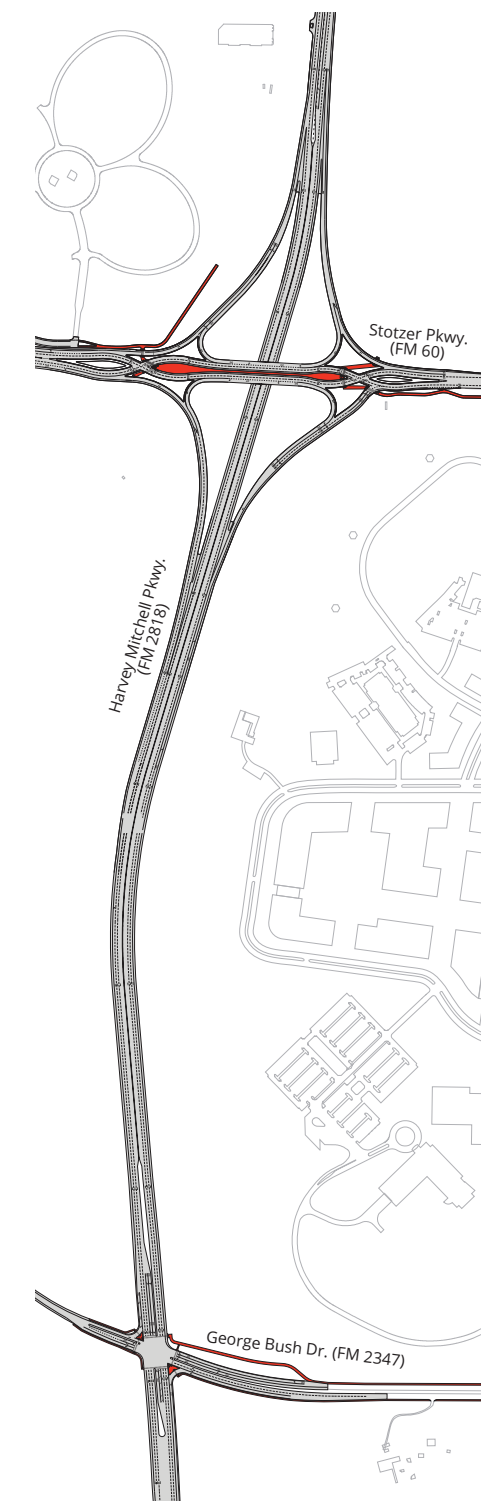

3. Texas Department of Transportation Diverging Diamond Intersection and Widening of Harvey Mitchell Parkway

Future Transportation Planning Initiatives

Technological advances in transportation will have a significant impact on campus mobility, and planning should keep pace as the technology of vehicles and travel changes. The strong business interest in automated and connected vehicle technology promises to create changes in mobility both on and off-campus. Autonomous parking has the potential of reducing the space requirements for stored vehicles. Automotive vehicle ownership may eventually shift from a private ownership model to a subscription service model, reducing the number of vehicles on campus. Electric assist bicycles promise to extend travel distances well beyond the campus core and immediate surrounding housing.

In anticipation of these changes, Texas A&M is conducting a two-year Transformational Mobility Study, focused on identifying emerging technologies and trends that may be leveraged to continue improving campus mobility strategies and safety while promoting social and environmental wellness. Pricing, cost-to-benefit ratios, and ease of implementation are expected to play some part in this evaluative process. As technology evolves, future planning efforts should still first and foremost emphasize pedestrian safety.

In the meantime, Texas A&M continues to serve as a testbed for innovative mobility technologies and safety improvements. One example is the recently completed Dutch junction intersection at Ross and Bizzell Streets. This unsignalized intersection separates motorist, cyclist, and pedestrian zones to improve traffic flow and safety. The bicycle lanes at the intersection have been marked with photoluminescent paint to make cyclists more visible to motorists at night.



Texas A&M Bus Piloting Collision Avoidance System



Texas Transportation Institute Initiative - Solar bicycle lanes at Dutch Junction, intersection of Ross Street and Bizzell Street





05

SUSTAINABILITY

- Introduction
- Energy and Greenhouse Gas Reduction
- Campus Mobility
- Stormwater Management
- Built Environment and Site Design
- Waste Management
- Social Sustainability
- Education, Outreach and Engagement
- Pedagogy, Research and Innovation
- Administrative Support



INTRODUCTION

Sustainability at Texas A&M is the efficient, deliberate, and responsible preservation of environmental, social, and economic resources to protect our earth for future generations of Texas Aggies, the Texas A&M University community, and beyond.

This Campus Master Plan addresses sustainability in concert with the June 2010 Sustainability Master Plan, biennial updates, and STARS reports. This plan works to evolve the content of those documents to keep pace with broader master planning efforts across campus, and a Sustainability Master Plan Update is planned after the completion of this planning effort.

While much of the content related to sustainability is discussed in this chapter, sustainability appears in the content of other chapters as well. This structure reflects Texas A&M's interconnected understanding of sustainability and allows content to be presented thematically. The June 2010 Sustainability Master Plan identified 12 themes that allowed the University to quantify its sustainability efforts, but did not align well with external reporting efforts nor robustly support flexible engagement with the broad range of stakeholders that contribute to sustainability initiatives across the institution. To support greater longevity, flexibility, and to more closely align with the Association for the Advancement of Higher Education's (AASHE) Sustainability Tracking, Assessment, and Rating System (STARS), this Master Plan identified 9 major themes broken down into operational and non-operational matters:

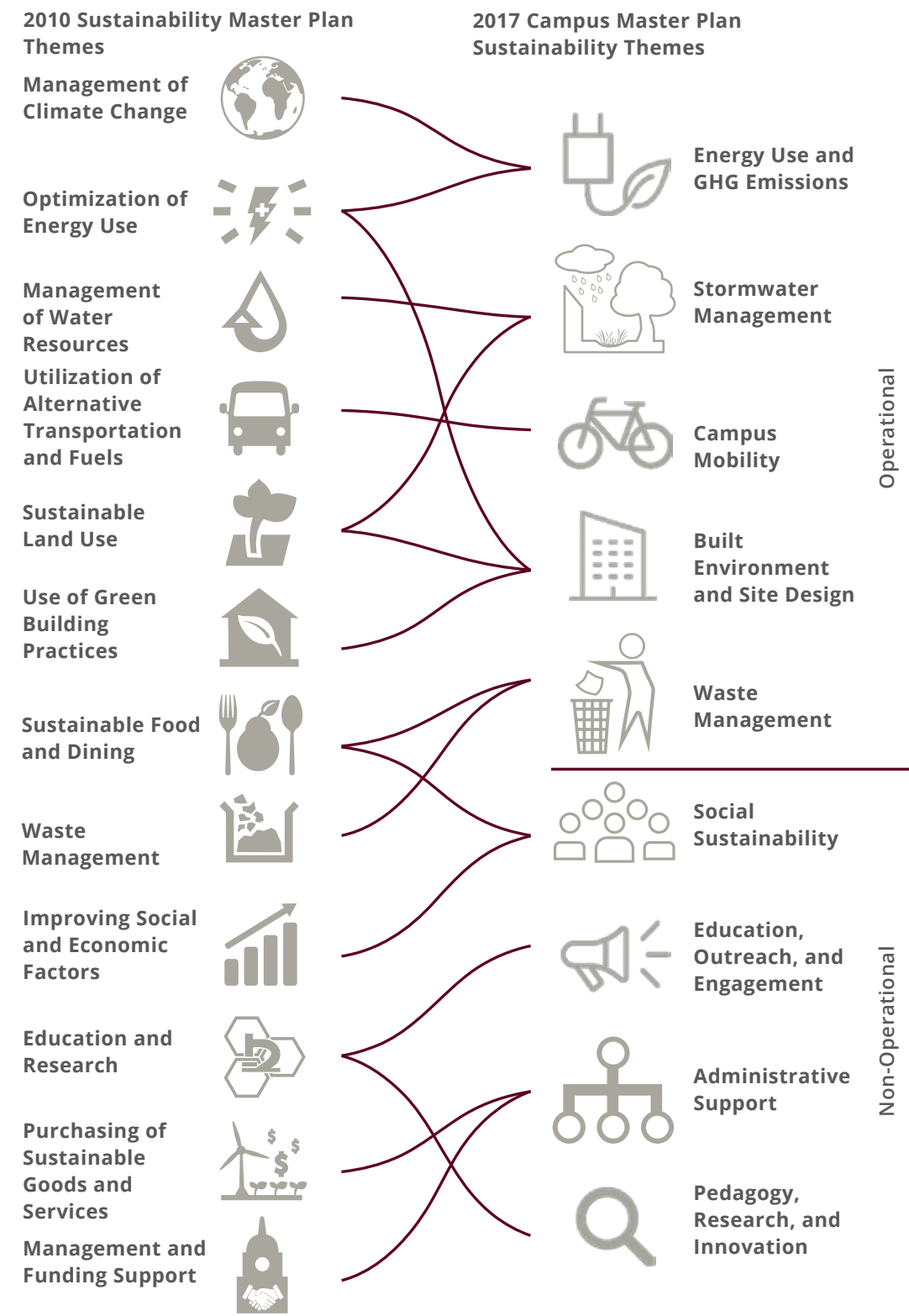

The nine themes of this Campus Master Plan include operational and non-operational items that are a natural evolution from the 2010 Sustainability Master Plan's twelve themes.



Content that addresses sustainability can be found across other focus areas of this Master Plan. Green tags such as this one appear on pages throughout the document to highlight sustainability information within other focus areas.

In reorganizing the themes, this Master Plan presents the same scope of content as the 2010 Sustainability Master Plan. Not all recommendations will have a physical manifestation, but all recommendations will support Texas A&M in achieving a more sustainable future and more cogently presenting that work to internal and external audiences.

Operational matters such as energy use and greenhouse gas reduction, campus mobility, stormwater management, and built environment and site design are addressed by multiple focus areas. For example, the Campus Development Plan, articulated in Chapter Three, illustrates a build-out scenario that responds to climatic factors such as orientation and rainfall. Chapter Four addresses mobility and safety by prioritizing the pedestrian experience which will inherently decrease the environmental impacts of transportation. While stormwater management is covered within this sustainability chapter, much of the campus guidelines on landscape plantings favor native species of the College Station area over high-maintenance specimen plants. Campus guidelines for building design and construction align with the performance criteria identified within this chapter. Content that addresses sustainability objectives is called out within other sections of this Master Plan where appropriate.

Waste management is supported by the Campus Master Plan but will require additional follow-up with campus operations staff to ensure progress continues. Non-operational matters including social sustainability; education, outreach, and engagement; administrative support; and pedagogy, research, and innovation are reinforced by the Campus Master Plan but will require internal coordination within the Texas A&M University community. Signage and wayfinding strategies identified in Chapter Eight discuss directional signage, but also describe the need for interpretive signage that will support the University in using campus as a learning laboratory.

Higher education institutions quantify their sustainable achievements using a variety of third-party rating systems. These tools provide benchmarks by which Texas A&M can measure its impact in the areas of people, planet, and economy and how that progress compares with peer institutions. Among rating systems relevant to the University, the three most prominent are:

- the Association for the Advancement of Sustainability in Higher Education’s (AASHE) Sustainability Tracking, Assessment & Rating System (STARS),
- the United States Green Building Council’s (USGBC) Leadership in Energy and Environmental Design (LEED), and
- the American Society of Landscape Architects, the Ladybird Johnson Wildflower Center at the University of Texas at Austin, and the United States Botanic Garden’s Sustainable Sites Initiative (SITES).

As this plan was developed, LEED 2009 was sunsetting and being replaced with LEEDv4. The University has a standing statement that building projects are designed to achieve LEED Silver equivalent, but with the changes in LEED, the definition of a LEED Silver equivalent building has changed substantially. While the University community encourages projects that are willing and able to pursue third party certification, perhaps the largest shift between the previous Master Plan and this plan is a move away from designing to achieve LEED Silver to instead be replaced by a more Texas A&M-specific sustainability strategy that draws upon the best practices outlined in STARS, LEED, and SITES. The landscape of green rating systems continues to evolve, however, and while the aforementioned rating systems are the foundation for a Texas A&M-specific strategy, the University should evaluate if other rating systems have substantive content that will support the University in achieving its sustainability vision.

Every member of the Aggie family works together to champion environmental stewardship, encourage healthy living, and improve social and economic opportunities and outcomes locally, nationally, and globally.

- TEXAS A&M UNIVERSITY SUSTAINABILITY VISION STATEMENT

Relation of Themes to Campus Master Plan

Included in the Master Plan:



Energy Use and GHG Emissions



Stormwater Management



Campus Mobility



Built Environment and Site Design

Supported by the Master Plan:



Waste Management

Advised by the Master Plan:



Social Sustainability



Education, Outreach, and Engagement



Administrative Support



Pedagogy, Research, and Innovation

ENERGY USE AND GREENHOUSE GAS REDUCTION

Texas A&M University has inventoried its greenhouse gas (GHG) emissions annually since fiscal year 2004 and has achieved notable successes to date – while the gross square footage of campus buildings has increased 35%, GHG emissions have decreased 45% leading to a smaller amount of GHG emissions per square foot of development. This condition has made Texas A&M a leader amongst its peers in terms of GHG emissions reductions. Campus continues to grow, however, and to continue decreasing GHG emissions per square foot of development and stay competitive with peer institution's GHG reduction targets, Texas A&M will need to further reduce energy use by upgrading equipment to more efficient models at the end of existing equipment's service life, renovating existing buildings to meet more stringent energy performance standards, and constructing new buildings prepared to achieve net-zero energy in future.

The existing Utilities and Energy Master Plan Update was completed in March 2012 and includes recommendations for both a five and thirty year timeframe. The five year timeframe nearly aligns with this Campus Master Plan. In the interim period between 2012 and today, Energy Action Plan (EAP) 2020 was developed which more specifically identifies energy efficiency strategies, parties responsible for those strategies' execution, and overall energy use intensity (EUI) target reductions for campus. In EAP 2020, Texas A&M University articulated a goal of reaching a Source EUI of 180 and Site EUI of 140 across campus. It should be noted that the 2003 Commercial Buildings Energy Consumption Survey (CBECS) average for campus / university buildings' Site EUI is 120. Using Labs 21, the average Site EUI for a laboratory building is 370. Texas A&M University operates a larger number of laboratory buildings than some collegiate environments so a Site EUI of 140, which is slightly higher than the 2003 CBECS campus / university building average is perhaps justified but should be tested through future UES planning efforts.

The recommendations below reflect what projects identified in the March 2012 Utilities and Energy Master Plan Update have been completed and what direction energy and utility infrastructure projects should take in the next phase of campus development. A more thorough analysis, including a life-cycle cost analysis, should be conducted to vet the recommendations provided. Utilities & Energy Services (UES) intends to update the UES Utilities and Energy Master Plan after the completion of this Master Plan.

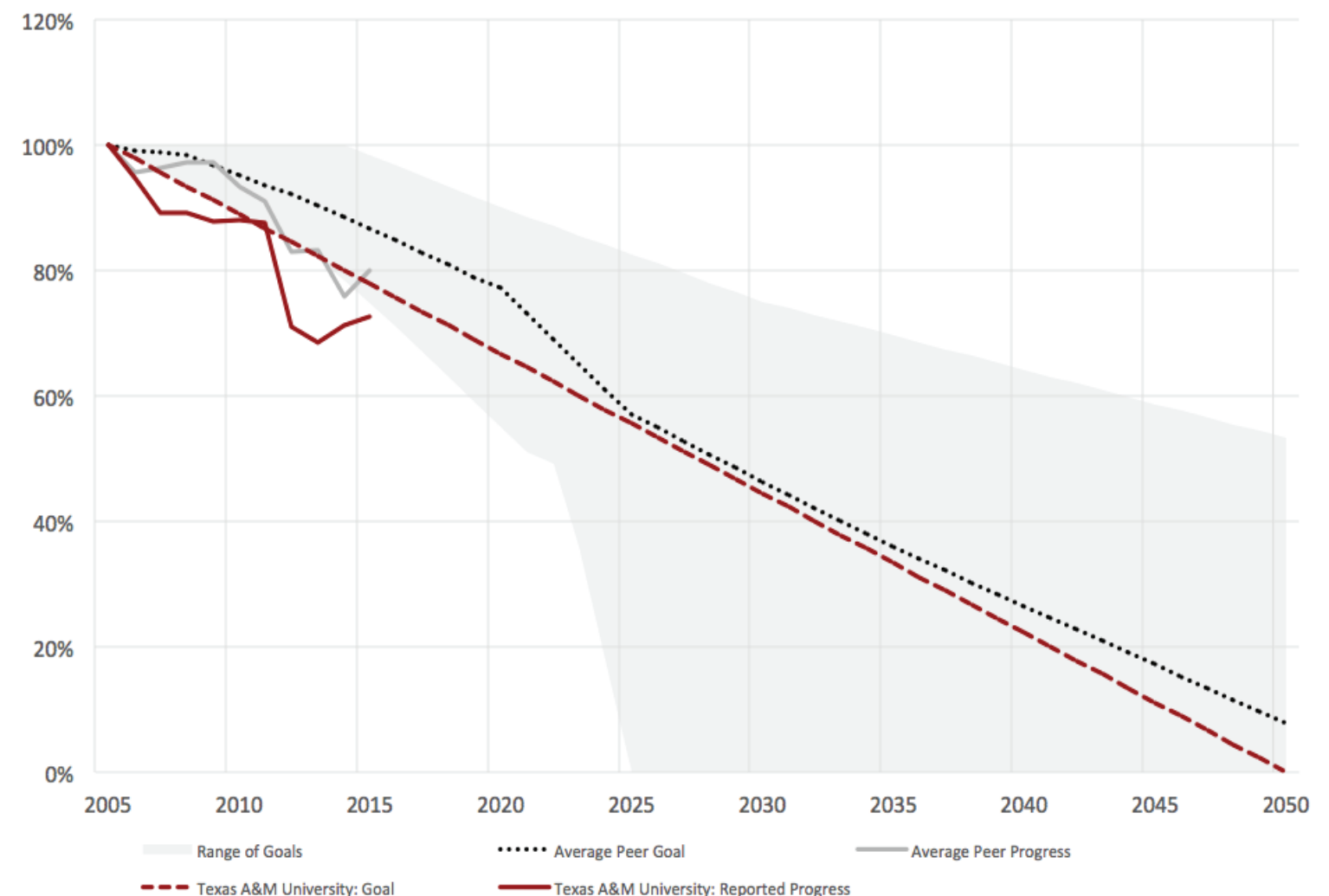

When compared to its peers, Texas A&M has already made great strides in reducing its GHG emissions because of significant investments at the CHP, but many smaller impact projects will need to be completed to continue advancing.

Optimize campus production and distribution

At a campus scale, efficient production and distribution networks, operational flexibility, and reliability to prevent outages are of critical importance.

Achieving the highest level of efficiency in campus-scale production and distribution benefits all downstream energy users and has the highest return on investment in terms of dollars spent versus energy use and GHG emissions reduced. To support efficient production, the broadest recommendation of this Campus Master Plan is to consider replacement for existing equipment that has passed its ASHRAE recommended service life.

Recommendations are provided by service type below, but the timing of individual actions is contingent upon the speed of campus development. Legacy improvements to the infrastructure systems at Texas A&M University have supported both the historically consistent pace of development on campus as well as more recent growth spurts. The pace of future infrastructure improvements should keep pace with development's speed so UES can continue to provide consistent, efficient service to campus buildings.

Electricity

Texas A&M University currently operates a highly efficient Combined Heat and Power (CHP) system that is capable of meeting most of campus's annual electricity needs. The CHP is comprised of a large gas turbine (34.5MW) and two steam turbines (11MW and 5MW). The smaller steam turbine (STG4 at 5MW) was completely overhauled per the recommendations in the 2012 Utility Infrastructure Master Plan. The 2012 plan also recommended replacement of Transformer 1, which has not happened as continued testing indicates this 30 year old asset continues to perform well. However, for reliability purposes, an additional transformer has been added to the primary distribution system. The next round of utility infrastructure planning should continue to assess the useful life of primary distribution assets and monitor on-site production opportunities and utility inter-connection needs.

Steam

Campus steam production is largely related to the combined heat and power system for the purposes of electricity and chilled water production. A relatively small campus steam distribution system exists for a select number of buildings. Boilers primarily use natural gas for fuel, although boilers 2 and 12 are also capable of burning fuel oil. N-1 capacity is currently in place. Major investments to the steam system were made with the CHP plant upgrade in 2011 and as such no immediate needs are evident.

Chilled Water

Campus currently operates 27 chillers using three refrigerants, HFC-134a, CFC-11, and HCFC-123. Refrigerants are evaluated based on their Ozone Depletion Potential (ODP) and Global Warming Potential (GWP) and in both metrics, the higher the value the more environmentally damaging the refrigerant. Texas A&M has a small inventory of CFC-11 chiller equipment that provides system redundancy. This equipment is planned for phaseout by 2020 and is infrequently used, but its refrigerant is among the most environmentally damaging. The University should avoid deferring the replacement of this equipment and/or seek out opportunities to use HCFC-123 in the existing equipment as HCFC-123 is understood to be a less environmentally impactful CFC-11 replacement. To support campus buildings in achieving LEED certification under LEEDv4, new chiller equipment should include no CFC-based refrigerants. The LEEDv4 rating system includes a prerequisite that requires projects use no CFC-based refrigerants. All buildings tied to central plant facilities that use CFC-based refrigerants will be unable to meet this prerequisite and as a result unable to pursue LEED certification.



The Central Utility Plant at Texas A&M University provides power across campus.

Refrigerant Usage at Texas A&M University			
Refrigerant	ODP	GWP	# of TAMU Chillers Using this Refrigerant
HFC-134a	~ 0	1,320	18
CFC-11	1.0	4,680	2
HCFC-123	0.02	76	7



As development in the southeast region of campus expands, UES anticipates SUP 3 will require expansion.

Heating Hot Water

Campus operates a large heating hot water system. Since the 2012 Utilities and Energy Master Plan, condensing boilers have been added to the system to provide efficient capacity additions to Satellite Utility Plant 1. To support campus development, Satellite Utility Plant 4 has been identified, with planning largely complete, so that it can add capacity for western campus operations by 2020. The next round of utility infrastructure master planning will necessarily update the 5-yr and 30-yr projections for replacements to the heating hot water system. To support Texas A&M's energy efficiency objectives, heat recovery chillers should be evaluated as load profiles evolve at each utility plant and the campus as a whole.

Water Supply and Wastewater Treatment

Texas A&M University operates both its own water supply system via seven deep wells in addition to its own wastewater treatment facility which eventually discharges treated wastewater into the Brazos River watershed. The existing wastewater facility has capacity to clean 4 million gallons of wastewater and, to date, the peak load is just half that, about 2 million gallons. Even as campus continues to develop, it is anticipated that this facility will sufficiently meet demand, although peak demand should be monitored as new buildings come on line. Two opportunities exist at the wastewater treatment facility: the prospect of treated water reuse in either irrigation or cooling tower makeup water and the use of constructed wetlands for wastewater treatment.

Water reuse would require pumping treated water back to service areas on campus which is currently not economically viable, but as water scarcity concerns evolve, the possibility exists that this type of undertaking could

both decrease Texas A&M's demand on the existing supply wells and provide opportunities for research and innovation. While the water treatment process currently used at the wastewater facility is a biological process, constructed wetlands could offer additional opportunities for engagement between UES, on-campus research, and curriculum. Developing these opportunities would be a significant way to use campus infrastructure to support the objectives of campus as a living laboratory.

Support building-scale energy efficiency

Texas A&M operates 24 million GSF of building space and intends to develop more. To support energy use and greenhouse gas reductions on campus, renovations and new construction must do their part to include appropriate energy efficiency strategies. Campus design standards have been established to create efficient buildings when considered in isolation and an efficient campus when buildings are considered as a complete system. New construction and renovation projects must approach building systems and energy use decisions with a "system" level perspective so that when inevitable budget constraints emerge a campus perspective can be applied to any value engineering effort required. If value engineering results in a less energy efficient building, that cost is paid every year in operational costs for the service life of that building asset.

Much that can be done on a building scale is identified in the Built Environment and Site Design section of this chapter, but there are a few specific measures that can ensure Texas A&M's buildings are prepared to engage with campus-wide energy use and GHG reduction strategies. Deviations from the guidelines provided below may be granted by the University on a case-by-case basis and shall be requested from design consultants in writing.

Server rooms support our digital world, but when distributed as small IT closets across many buildings, these spaces limit night setback opportunities because they require constant cooling. To continue reductions in energy use and greenhouse gas emissions, these HVAC-intensive spaces should be consolidated into a set of centralized hubs. Server and IT closets that require cooling outside of normal operation hours (approximately 8 am – 6pm) in renovations and new construction are incompatible with the institution's energy savings goals. If absolutely required in a renovation or new construction, server and IT closets must be provided with local HVAC control that does not require the whole floor or whole building to meet the HVAC requirements of the server or IT room.

To date, Texas A&M University has installed 15,000 occupancy sensors across existing facilities that are tied to both lighting and HVAC systems. The intent of the occupancy sensors is simple: if people aren't using a space, turn off the lights and power down the HVAC system to save energy and reduce energy expenses and greenhouse gas emissions. New construction and renovation projects will include occupancy sensors tied to both HVAC and lighting systems in the spaces required by ASHRAE90.1-2013. Design teams shall see specifically 6.4.3.3.1 Automatic Shutdown, 8.4.2 Automatic Receptacle Control, and 9.4.1.1 Interior Lighting Controls, i. Scheduled Shutoff.

Texas A&M has invested significant time and money in building-scale energy metering that allows UES to track building performance. UES has also inventoried the largest energy using buildings on campus to aid the institution in prioritizing retrofits. The 50 largest energy using buildings on campus account for \$37 million for annual energy expenses. Building-scale new construction and major renovations will, at minimum, include building-scale energy and water metering. To increase the scope of campus's utility information database and support individual projects in achieving LEED certification under LEEDv4, consider sub-metering for energy and water systems. Energy sub-metering should be able to track any individual energy end uses that represent at least 10% or more of the building's annual energy

consumption. Water sub-metering should be able to separate the water usage of irrigation systems, indoor plumbing fixtures, domestic hot water systems, boilers of at least 100,000 gallons or 500,000 BtuH, and any system using reclaimed water.

Education, outreach, and engagement

While a section of this chapter discusses the need for education, outreach, and engagement to raise the level of campus discourse on sustainability in general, there is a specific need to educate, outreach, and engage the University community on matters of energy use. Buildings do not use energy; people use energy to maintain our human comfort and operate our equipment. There is much that can be done to improve campus-scale energy production and distribution and support building-scale energy efficiency, but changes in the campus community's behavior will also significantly impact energy use and greenhouse gas emissions.

Education

Texas A&M University has engaged in a broad building-scale metering program that allows UES to report monthly energy usage for each building on campus. When tracked over time, this information illustrates energy use trends and can identify spikes in energy usage which may suggest equipment requires servicing. Making this data publicly available via an online dashboard would provide a feedback loop to campus users about the impact their activities have on the institution's energy use and expenditures. This data could also then be available for academic work, allowing UES to partner more easily with courses in energy management, statistics, and many other subject areas. Over time, other data logged by building management systems could be shared through a similar portal that would support the campus-wide objective of using campus as a living laboratory for innovation.

Outreach

UES has hosted tours of both the central utility plant and the wastewater treatment facility for members of the campus community and the general public. This type of outreach should continue and is a great way for end users to better understand their relationship to the very complicated networks that serve campus's basic energy and water needs. Increasing awareness through site tours and other means tends to influence behavior and can help better integrate infrastructure into Texas A&M's living laboratory campus.

Engagement

Projects that build and repair Texas A&M's utility capacity and distribution system occur both as infrastructure-only projects and as part of individual building projects. Moving forward, infrastructure-only projects should continue to support the service network, but individual project teams should increase their engagement with UES as part of the review of schematic design, design development, and construction document deliverables to verify the relationship between project-scale work and infrastructure-only work is aligned. If a building project requires the redirection of or additions to the utility distribution network, the University can more cost-effectively spend its budget if a project locates that infrastructure to serve both the immediate project as well as future development instead of doing what's right for the project at hand only to have to come back before the service life of that infrastructure is reached to redirect or upsize it for the next project that comes on line.



Generating renewable energy on-campus could support education and research goals while providing low-impact energy resources for campus operations.



One of the tables at Campus Sustainability Day gave the campus community an opportunities to learn about the Office of Energy Management. This kind of engagement expands the campus community's understanding of how their actions play a role in Texas A&M's sustainability.

By the Numbers

Many investments and successes have already occurred to reduce Texas A&M's GHG emissions:

6

full-time UES energy stewards

15

building automation system technicians

15,000

occupancy sensors powering down lights and HVAC when spaces are unoccupied

2,500

energy meters reporting use in TAMU buildings over 5,000 GSF

45%

decrease in campus EUI since 2002

CAMPUS MOBILITY

Transiting Texas A&M University's students, faculty, staff, and visitors to the locations they need to access on the institution's approximately 5500 acre campus has significant environmental and economic impact. In addition to safety, this Campus Master Plan prioritizes improvements to the pedestrian experience above other forms of transit because walking has the lowest environmental impact of the transit modes used at Texas A&M. Walking also supports the University's goals for student, faculty, and staff health and wellness.

Because campus covers such a large area, there often isn't time to transition between classes, meetings, or other activities via walking. Bicycles and public transportation, including the campus bus network, have a lower environmental impact than single occupancy vehicles and allow transit to happen more quickly than walking. As bicycle and bus connections to the College Station and Bryan region strengthen, the possibility exists that more students, faculty, and staff could use those systems exclusively to meet their transit needs and thereby allow Texas A&M to invest more construction dollars into academic spaces than parking spaces as the campus population grows. To decrease GHG emissions from campus operations, the University should work with the surrounding community to increase public transportation access off-campus.

The 2015 Bicycle District Strategic Plan articulates goals and performance measures around engineering, education, encouragement, and enforcement. To decrease mobility's environmental impacts, the Bicycle District Strategic Plan should be implemented and coordinated with the measures outlined in Chapter Four to improve the safety of multi-modal transportation at Texas A&M including multiple bicycle lane typologies. This Master Plan also includes recommendations about priority areas for bus network expansion.

Parking needs for service and delivery as well as emergency access will support the building development and robust outdoor spaces encouraged

by the campus development plan. Access for service and delivery vehicles should create minimal disruption to the pedestrian environment but allow maintenance to sustain optimal operations.

Taxis and ride-share services will be accommodated while minimizing disruption to through traffic. The University will consider strategies to preference multi-occupant vehicles over single-occupant vehicles including preferential parking access and rates for carpools.

Building on existing transportation work at Texas A&M, much of this Master Plan focuses on strategies to minimize conflicts among pedestrians, bicycles, buses, and personal vehicles including additional locations where grade separations like the successful Pickard Pass could be valuable.

Events, such as football games, commencement, move-in, and move-out create unique mobility environments requiring special consideration. To learn more about how Texas A&M plans to address mobility, see Chapter Four.

Mobility Hierarchy

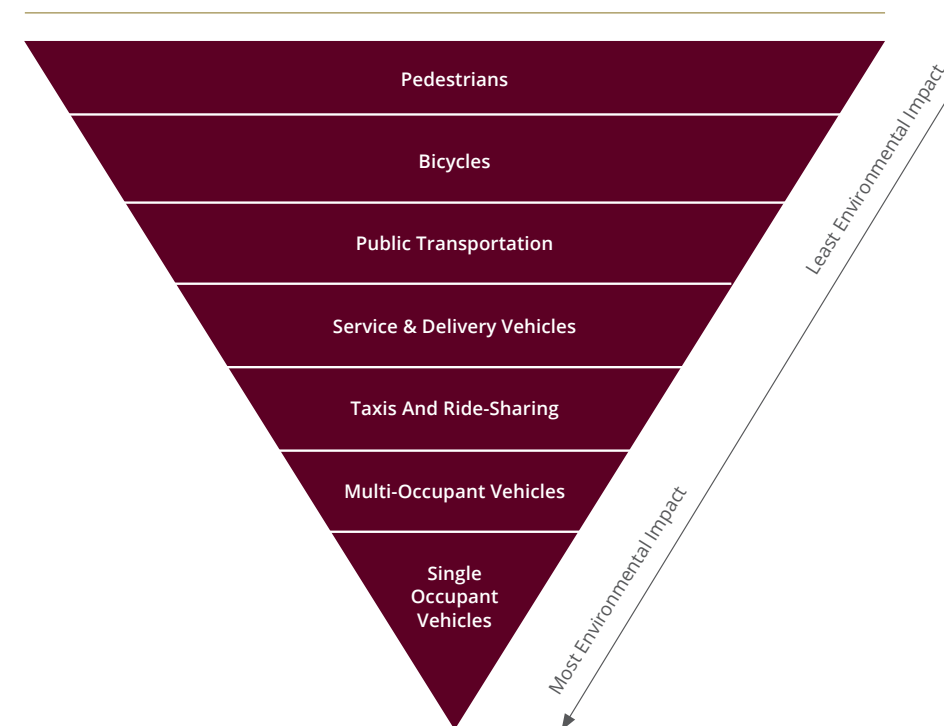

STORMWATER MANAGEMENT

Hardscape and buildings alter the hydrologic cycle by decreasing stormwater infiltration and increasing stormwater runoff. The existing stormwater network at Texas A&M was developed to serve a campus with considerably less hardscape than the University has developed to date and as a result campus has significant challenges managing stormwater runoff. The predominantly clay soils of the region also contribute to the University's challenges with stormwater management as it has little capacity to retain water and becomes inundated from relatively modest storm events. The 95th percentile storm at Texas A&M is a 1" storm and even this volume of water has difficulty infiltrating into College Station's soils. Implementation of low impact design (LID) strategies to manage stormwater will support the University's high-performance goals as well as its academic objectives.

Replacing the existing components of the stormwater management system in their entirety to handle the current volume of stormwater runoff is not an economically feasible solution, but future development must be created that does not exacerbate this existing campus-wide challenge. Achieving more successful stormwater management will require actions at the campus scale, character zone, and project scale that employ LID strategies. LID prioritizes the use of landscape infrastructure over piping infrastructure, to protect water quality and manage stormwater volume, although LID strategies are frequently used in tandem with piping. Campus and character zone scale considerations are discussed below while project scale recommendations are outlined in the campus guidelines. As a general rule, individual projects must preserve a post-development condition that, at minimum, matches pre-development conditions and preferably produces less runoff than pre-development conditions.

To further decrease Texas A&M's impact on local hydrology, minimize the volume and toxicity of fertilizer, chemical cleaning products, and other human-introduced, water-borne pollutants that could enter waterways or groundwater systems.

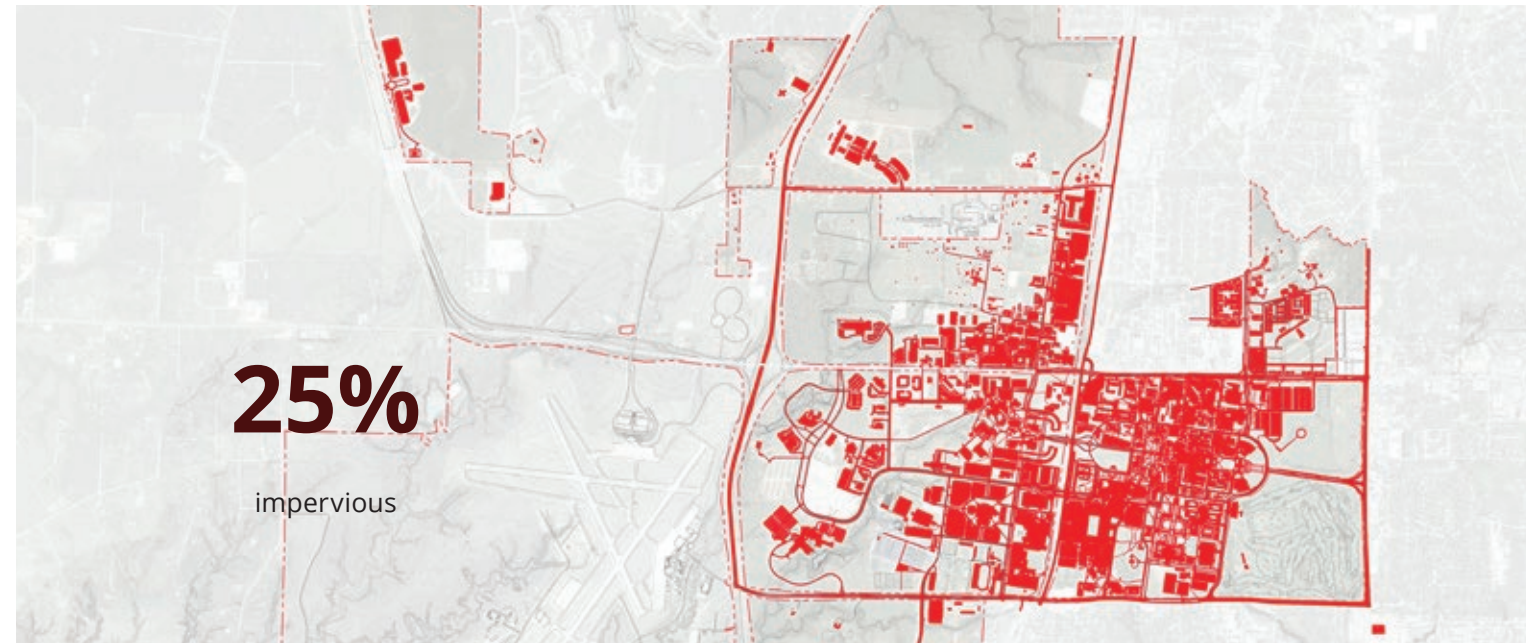

Existing impervious surfaces on campus including hardscape and building footprints cover 826.8 acres of the 3,307 acres of planning boundary addressed by this Master Plan. 25% of the planning boundary is impervious.

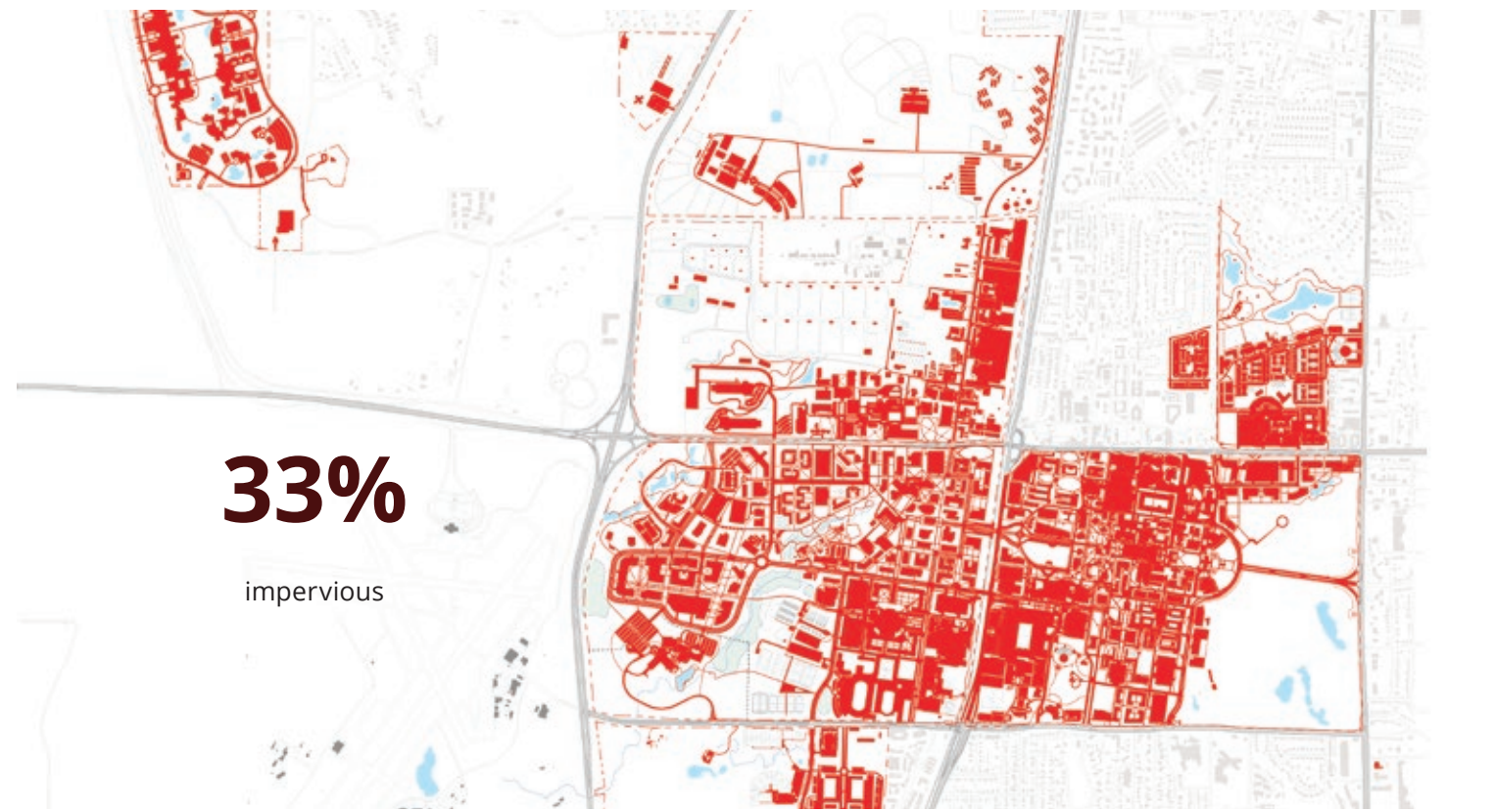

In the conditions proposed by this Master Plan, campus could include 1091 acres of hardscape and building footprints over the same square footage of campus area addressed by this Master Plan. 33 % of the proposed campus would be impervious.

Manage Stormwater at the Campus Scale

Align with College Station's Unified Stormwater Design Guidelines:

Campus scale stormwater management solutions at Texas A&M should support the University's good neighbor relationships with the City of College Station and Brazos County. College Station developed their Unified Stormwater Design Guidelines (<http://www.bcsunited.net/>) using empirical observations and analysis of College Station's geographical location, existing drainage patterns, and predominant soil types. As a public state institution, the University's property is state land and not subject to city or county regulations or approval; however, the City of College Station's stormwater regulations have proven to be effective at managing stormwater in the area and should be followed as closely as possible on campus. Texas A&M retains the option to fully adhere to local regulations or determine which regulations are too restrictive on a case-by-case basis.

Deviations from the City of College Station Stormwater Design Guidelines may be granted by the University on a case-by-case basis and shall be requested from design consultants in writing. Requirements that are not subject to waiver include:

- Minimum street slopes of 0.60% shall be maintained for all named streets
- Maximum gutter velocity shall be 10 fps
- 10 year storm events must be contained within curbs of streets
- 100 year storm events must be contained within the right-of-way
- Curb inlets are assumed to operate at a maximum 90% of capacity
- Grate inlets are assumed to operate at a maximum 75% of capacity
- Storm sewer systems, including open ditches, shall be designed to fully contain 100 year events for proposed projects or ultimate buildout, whichever is greater. Assumptions about future quantity reductions (i.e. underground detention, cisterns, etc.) shall be that they are not implemented

- Maximum pipe velocity shall be 15 fps
- Minimum pipe velocity shall be 2.5 fps
- Human access points shall be provided for changes in pipe size, grade, and alignment, with maximum spacing of 300' for pipes of diameter 54" and smaller and 500' for larger pipes
- Minimum acceptable pipe diameter in streets shall be 18". Smaller pipes may be used to collect from roof drains, area inlets, etc. on a site
- Pipes of 24" diameter and smaller are assumed to operate at 75% capacity
- For pipe size changes, pipe soffits shall match
- Minimum of 0.1' drop across all inlets and manholes
- In storm profiles, hydraulic grade line (HGL) for 10 year event shall be shown, and shall be at least 6" below the inlet opening, gutter elevation, or finished ground, whichever is lowest
- In storm profiles, HGL for 100 year event shall be shown, and shall follow rules set above



This rain garden at the Interdisciplinary Life Sciences Building manages stormwater while also providing a visual amenity and ecosystem services to campus.

Size Stormwater Mains Correctly:

Texas A&M's stormwater mains were sized to serve an earlier phase of campus development with fewer buildings and less hardscape. Over the years, a variety of design solutions have served stormwater management functions and many original or older stormwater mains are undersized for their current drainage areas. Moving forward, it will be the responsibility of individual building projects, as well as larger infrastructure-only projects, to correctly upsize existing systems to handle the anticipated 100 year storm event. Appropriate stormwater line sizes will be provided by the University for all mains. Failure to update these existing systems will exacerbate existing flooding issues on campus as building footprints expand.

Remove Unnecessary Cross-Connections in Stormwater Mains:

Attempts have been made to alleviate localized flooding issues by interconnecting stormwater mains that were intended to run parallel. These connections have introduced turbulence and decreased velocities in the pipes, decreasing capacity and increasing localized flooding problems. When working in an area, design teams and/or the University shall review the stormwater system and remove unneeded connections. Sizing stormwater mains correctly in tandem with removing cross-connections will address many campus flooding problems.

Conduct Public Outreach and Education:

Texas A&M uses small stamps and stickers on some inlets across campus to indicate what waterway the inlet leads to. This type of interpretive signage should be used on all applicable inlets to educate the campus community about its connection to the regional water system. New projects that implement physical best management practices (BMPs) should advertise their efforts and post permanent, tasteful signage on or near the BMP explaining, in layman's terms, what it is, what it does, and why it is used. Stormwater management practices are an opportunity for the campus to teach end users about environmental efforts.

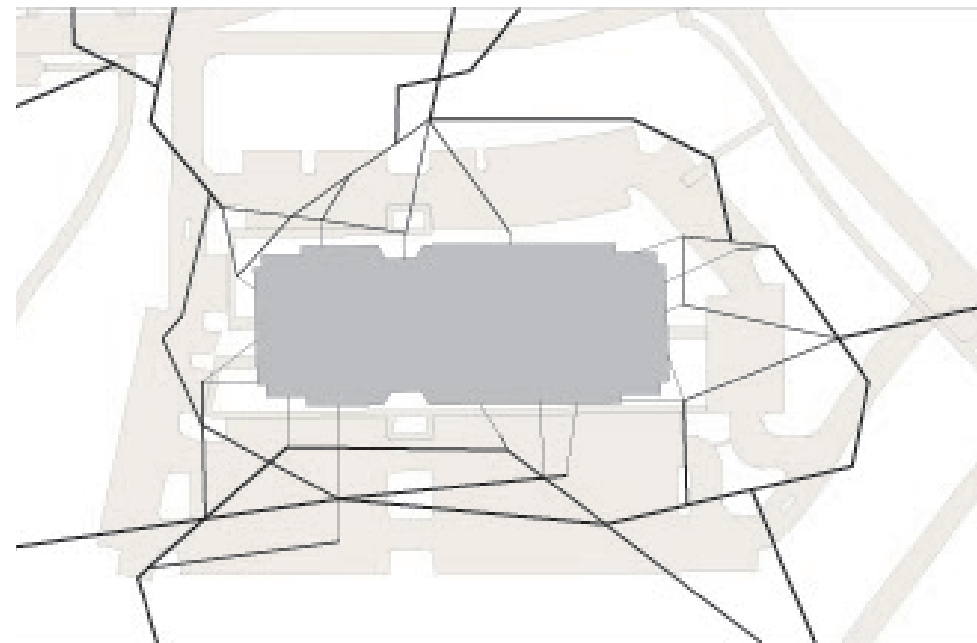

Existing cross-connections in stormwater mains create turbulence and decrease water velocity in piping, which in turn decreases capacity and causes localized flooding.

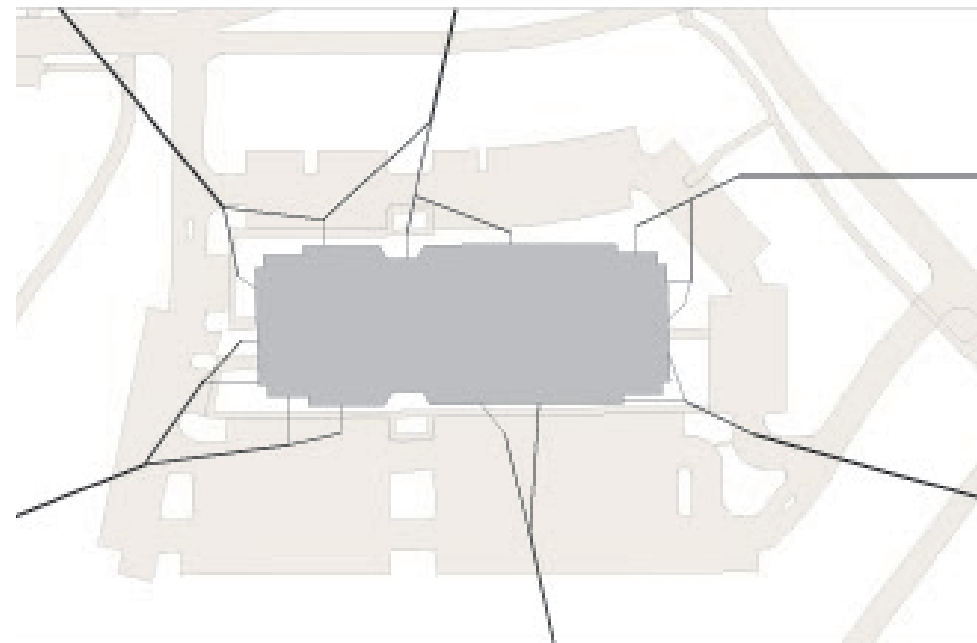

Removing cross-connections and clarifying where stormwater is directed in properly sized stormwater mains could address many localized flooding problems.



Labels should be installed across campus to help occupants understand their connection to the regional water system.



This project at the University of Delaware integrates stormwater management BMPs into aesthetic amenities that provide small gathering spaces to the university community.

Manage Stormwater at Character Zone Scale

At the character zone scale, designers should address stormwater issues in a consistent manner across adjacent sites to support the aesthetic objectives of each character zone. Each character zone preferences certain types of best management practices (BMPs) while disincentivizing others. As an example, dry detention basins are likely inappropriate in more urban areas of campus because the real estate is limited and building density is a primary goal. Alternatively, underground detention is likely undesirable in planned low-density areas of campus where that strategy may be cost prohibitive and unnecessary because land is readily available. The chart at the end of this section summarizes a number of low-impact development best management practices and which character zones they are most appropriately applied to, although design teams and the University should evaluate this guidance on a case-by-case basis.

While no stormwater management system can operate indefinitely without maintenance, the LID strategies identified below require less maintenance than stormwater management practices to support turf grass. In their design phases, engineered soil media will likely be required to make many of the strategies identified below successful because of Texas A&M's existing soil conditions. Employing a commissioning process as such systems come online is recommended to ensure systems perform as intended to meet Texas A&M's requirements. Consistent sources of funding must also be found to keep stormwater management systems operational over time; deferred maintenance will contribute to flooding issues on campus after storm events.

Consider Engineered Bioswales and Rain Gardens:

Stormwater runoff becomes polluted by transiting hardscape, introducing contaminants into ecologically productive streams and rivers, causing flooding, and creating erosion unless channeled and slowed by stormwater management features such as engineered bioswales and rain gardens. Engineered bioswales tend to direct and channel stormwater away while rain gardens tend to collect water and infiltrate it in place. In either case, these



Bioswales



Rain Gardens



Bioswales and Rain Gardens

landscape elements primarily filter silt and pollution from the first 1.5" of rainfall in any given storm event. The 95th percentile storm event in College Station is a 1" storm, so engineered bioswales and rain gardens could filter most College Station rain events and double as water quantity BMPs. These features can be engineered to include water storage substrates and native, deep-rooted vegetation. Strategically placing these stormwater management features could help the University remediate polluted water before it makes its way into underground infrastructure and add aesthetic value to the campus's overall landscape vision. The native planting these features use would also create habitat for birds, butterflies, and insects. Engineered bioswales and rain gardens could be successfully used in medians, parking lot edges, and buffers between sidewalks and vehicle traffic. When supported by signage, bioswales and rain gardens offer great public education opportunities.

Consider Dry Detention Ponds:

Dry detention ponds should be used sparingly, if at all, because they tend to be unsightly and occupy large amounts of land. Used primarily to prevent flooding, this BMP typically holds water for 24 hours or less and otherwise appears as a grassy field. The short duration of inundation keeps mosquito larvae from reaching maturity, but if a dry detention pond holds water for

longer than 24 hours, aerators, agitators, or other mechanisms should be employed to discourage mosquito populations. When used, designers should look for opportunities to allow future improvements in the bottom of the basin. Options include, but are not limited to, running tracks, fixed fitness equipment, and play fields. The bottom of the basin will be under water during and after storm events, so improvements must consider fully saturated soils and include signage for safety.

Consider Permeable Paving:

While traditional hardscape materials do not allow water to infiltrate the soil, permeable paving allows stormwater to percolate and infiltrate the ground surface. The goal of permeable paving is to control and mitigate stormwater at the source, reducing runoff and improving water quality in substrata layers. Campus soils at Texas A&M do not lend themselves to permeable paving in the classic sense, but this does not mean they cannot work. In College Station, this BMP relies on proximity to storm sewer systems which will require extra excavation backfilled with angular aggregates and a large percentage of void space. The key on Texas A&M's campus is that sub-drainage systems (a series of smaller-diameter pipes) will be required due to the predominantly clay soils of the region which do not drain quickly. The voids between the aggregates would then allow water storage for a small storm event or manage the water

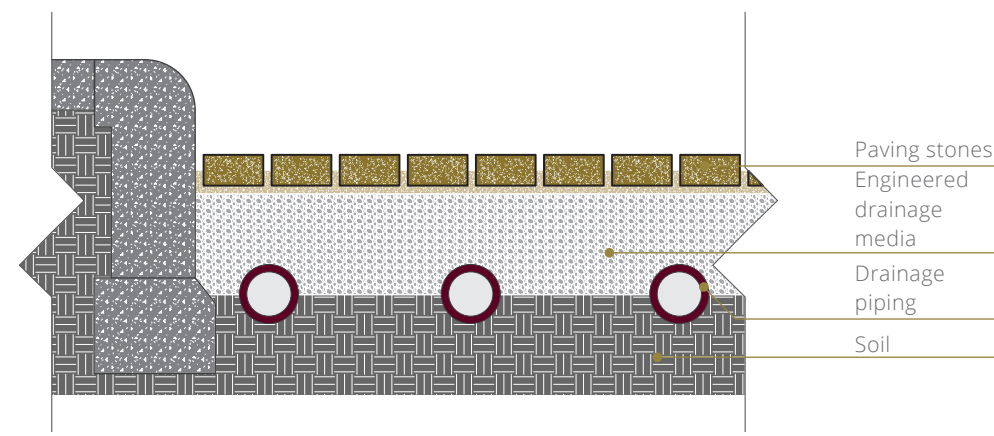

Permeable Paving



Wet Pond



Permeable Paving

quality of the first flush of a larger storm. The first flush tends to be the most polluted and catching these contaminants in the void space of the rocks could improve the longevity of downstream stormwater management fixtures. Permeable paving requires regular maintenance which needs to be detailed in the project specifications as suggested by the system manufacturer. There are many paved areas on campus that would be excellent locations to implement permeable paving including parking lots, service roads, corridors, edge conditions, and pedestrian and bicycle paths through campus.

Consider Wet Ponds:

When space allows, a wet pond can serve stormwater retention and detention functions as well as provide aesthetic value. Wet ponds can also provide a non-potable source for irrigation water, but because the pond will also be an amenity, a minimum level for the pond should be set. Care must be taken to keep the pond from going dry and its development should be accompanied by an engineering study of irrigation demands, rainfall amounts, and evaporation rates. The location of wet ponds should be set in part by the watershed of the site. Because water flows downhill, placing wet ponds in existing low-lying areas ensures significant volumes of water will flow to the basin during rain events and become available for secondary uses.

Consider Tree Wells or Trenches:

Tree wells and trenches are a stormwater management technique that uses trees planted in amended soils and rocks to capture runoff from surrounding hard surfaces and store it underground. These features can be single (tree wells) or interconnected (tree trenches) and may have grates over the top to allow pedestrians to walk up to the trees or be open earth when protected from foot traffic by seat walls or other barriers. Tree trenches may be very effective in areas of campus that have limited space to manage stormwater such as along streets, major pedestrian corridors, and parking lots. The presence of this type of landscaping also breaks up large, improved surfaces, and if trees are tall enough could provide shade to pedestrians and improve

the campus experience. Individually, a single tree well will not significantly impact the quantity of stormwater, however a series of tree wells, or an interconnected series of tree trenches can accept a large amount of runoff and pass that water through to the soil to also act as a strong water quality BMP. Water typically enters tree trenches through curb cuts or trench drains, but it may be piped directly underground into the gravel beds. Because water can be stored in the space between the stones, the trees have additional time to absorb the water. On campuses with clay soils very little water infiltrates through the bottom of the trenches so it is important that overflow is included in the design so that excess water can be drained from the trench if it reaches capacity. Tree trenching is a viable method for all tree plantings on campus, allowing for a more aesthetic tree planting method as well as a successful technique of stormwater management and tree watering. When trenches are used, it also provides an opportunity, much like the bioswales, to invite the public to learn about their use. Monument markers can be used to explain their purpose in detail while large letter text can be etched into seat walls or curbing to highlight the system's overall capacity.

Consider Rainwater Harvesting:

Rainwater harvesting is the collection and redistribution of rainwater for reuse on-site and can include wet ponds, but this recommendation is aimed at encouraging the use of cisterns. Cisterns can be above or below grade and have been used effectively on campus in multiple projects. By capturing rainwater from roofs before it crosses the ground, rainwater is kept cleaner and thus is appropriate for reuse in irrigation. This alternative water supply can be particularly important during times of drought when mandatory water restrictions may be in place. Reducing the demand for potable water on campus decreases expense and minimizes the strain communities experience when potable water supplies are overused. Above ground cisterns can be masked as faux structural components of a building or designed to be aesthetically pleasing while making maintenance less expensive and easier for the tank's design life. Rainwater harvesting systems can range



Rainwater Harvesting



Tree Trench

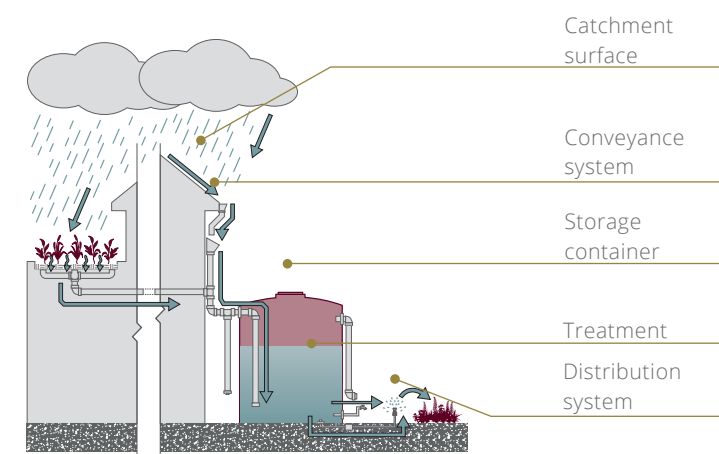

Rainwater Harvesting

in size and complexity, but all systems include a catchment surface, a conveyance system, a storage container, treatment, and a distribution system for its secondary use. Cisterns also provide a great opportunity for public engagement via signage that describes their function and effectiveness by managing stormwater and minimizing potable water use in irrigation.

Consider Vegetated or Green Roofs:

Green roofs manage the urban heat island effect, retain stormwater, provide habitat for insects and birds, add aesthetic value, lengthen the life of roofing materials, and add insulation to decrease heating and cooling costs. These systems can be extensive or intensive depending on the amount of growing medium required to support plant life year round. Extensive systems are typically 4 inches (10 cm) in depth or less, can be built-in-place or pre-planted in trays, and support the growth of sedums and other small plant species with limited implication on a building’s structural system. Intensive systems are typically 8 inches (20 cm) or more in depth and can support a greater

variety of plant species. Intensive systems require significant coordination with a building’s structural system. There are currently several examples of successful rooftop garden installations on Texas A&M’s campus and the hope is to grow the number of these spaces in new campus buildings. These areas can be marketed as amenity spaces for buildings and can showcase sustainable design while being popular small gathering spaces.



Green Roof

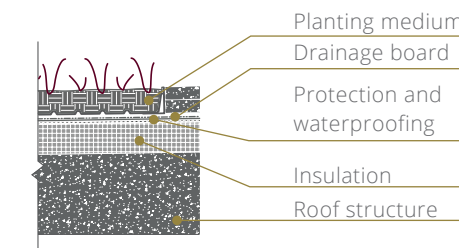

Extensive

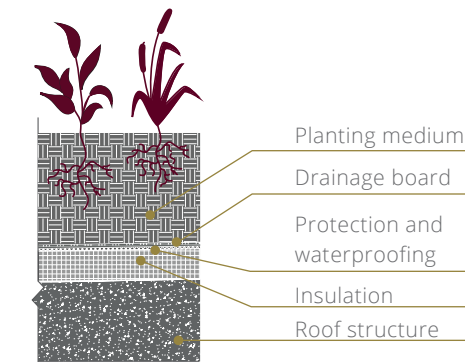

Intensive

Green roofs can be intensive or extensive depending on soil depth.

BMP Priority Locations	Best Management Practices (BMPs)						
	Bioswales & Rain Gardens	Dry Pond	Permeable Paving	Wet Pond	Tree Wells & Trenches	Rainwater Harvesting	Green Roofs
Hensel Park	*		*	*	*	*	*
Campus Front	*	*	*	*	*	*	*
Campus Entry & Golf Course	*	*		*			*
Southside	*		*		*	*	*
Historic Core	*		*		*	*	*
Northside	*		*		*	*	*
West Campus	*		*	*	*	*	*
Athletic & Recreation	*	*	*	*	*	*	*
Bush Library	*		*	*	*	*	*
Research Park	*		*	*		*	*
University Dr. & Agronomy Rd.	*		*	*		*	*
F & B Road	*	*		*		*	*
Health Sciences Center	*		*	*		*	*

This chart summarizes the BMPs described above and what character zones they are most appropriately used within. The University should evaluate this guidance with design teams on a case-by-case basis and ensure appropriate maintenance protocols are developed to realize the long-term value of these strategies.

BUILT ENVIRONMENT AND SITE DESIGN

The Texas A&M UES Guidelines state that projects are to be LEED Silver equivalent but may or may not be certified by the Green Building Certification Institute (GBCI). At the time this guideline was articulated, GBCI certified projects under LEED 2009, but this system sunset on October 31, 2016 and was replaced by LEEDv4, a significantly more robust green building rating system. Developing LEEDv4 Silver equivalent projects may or may not be appropriate to Texas A&M's performance objectives and the institution must determine what elements of LEED 2009, LEEDv4, and SITES are appropriate for future campus development. While each of these systems have unique attributes, they share common ground that will help Texas A&M operate their existing 24 million square feet of building space more efficiently in addition to developing new projects to their best performance abilities.

Adopt Appropriate Facility Performance Criteria

The energy code requirements for Texas A&M University require new construction projects to exceed ASHRAE90.1-2013 by 6% and require renovations to meet the existing building provisions of ASHRAE90.1-2013. This standard is inconsistently achieved because of the variety of compliance methods that standard allows. To keep pace with the increasingly complex green project certification standards that exist in today's building industry, Texas A&M must develop specific, enforceable guidelines empowering the Design Review Sub-Council to verify all design consultants and construction contractors for the University meet Texas A&M's intention to build high-performance projects.

The facility performance criteria should articulate:

- Minimum energy modeling criteria that verify projects meet the existing building requirements of ASHRAE90.1-2013 for renovations or exceed it by 6% for new construction.
- Maximum levels of VOCs permitted in sealants, paints, coatings, flooring systems, wood, furniture, and agrifiber products.

- Bicycle storage and end-of-trip amenities sized to meet the anticipated usage of various building programs.
- Minimum Solar Reflectance Index (SRI) requirements for roofing and hardscape materials.
- Backlight, upright, and glare requirements for exterior lighting fixtures.
- Lighting power density requirements for interior renovations or new construction projects that are interior-only in scope.
- Maximum percentages of landscape area that can be planted with turf grass.
- Performance-based specifications for permanently installed irrigation systems.
- Minimum performance requirements for commercial flush and flow fixtures.
- Minimum glazing performance requirements that exceed code minimums.
- Maximum glazing percentages that are less than code maximum.
- Minimum percentages of construction waste that are to be diverted from landfills.
- Minimum expectations for construction processes that support indoor air quality.
- Minimum percentages of construction materials that are to be sourced from recycled content.
- Minimum percentages of construction materials that are to be sourced from within 500 miles.
- Minimum percentages of new wood materials that are to be FSC certified.
- Minimum pass rates for indoor air quality testing prior to occupancy.
- Indoor environmental quality criteria for air quality, lighting, thermal comfort, access to daylight and views, and acoustics.
- Minimum requirements for building-scale metering and sub-metering infrastructure for energy and water systems to support UES campus-wide initiatives and continuous commissioning.
- Easy-to-service building-scale recycling facilities in addition to localized collection.
- Service infrastructure and access points to support cisterns and green roofs.

Provide A Healthy Indoor Environment

Providing an indoor environment that adequately addresses air quality, thermal comfort, lighting, and acoustics responds to the overwhelming evidence that the design of educational environments impacts the health, well-being, and productivity of occupants. To support an equitable academic experience for all students on campus, Texas A&M should work to meet minimum indoor environmental quality criteria in all renovations and new construction projects.

Provide High Indoor Air Quality:

Participants in a 2015 Harvard University Chan School of Public Health study scored significantly higher in cognitive function tests when working in well-ventilated spaces with below-average levels of common indoor air pollutants and carbon dioxide. Regardless of ventilation strategy, limiting contaminants is the first of several steps to ensure high indoor air quality and a conducive learning environment.

Within the facility performance criteria, specify maximum VOC content permitted in adhesives, sealants, paints, coatings, flooring systems, wood, and agrifiber products that are installed within a building's weather barrier. Provide exhaust and containment requirements to keep contaminants from hazardous spaces (laboratories, janitor's closets, laundry rooms, etc.) from

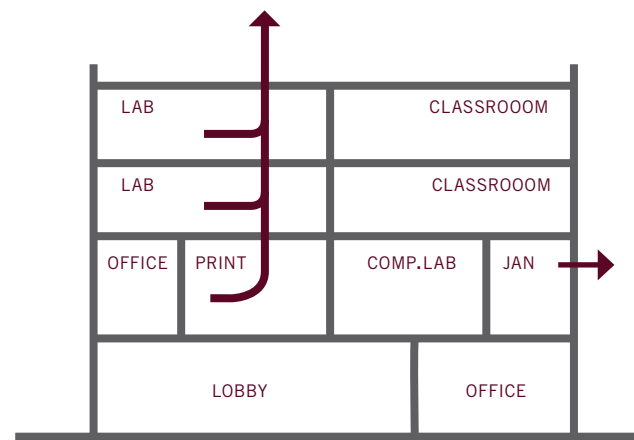

Provide direct exhaust to indoor spaces that may contain indoor air contaminants to keep these spaces from having a negative effect on adjacent spaces.

impacting adjacent spaces such as pressurization, hard ceilings or deck-to-deck partitions, and self-closing doors. Provide permanent entryway systems at primary building entries to minimize particulates tracked in by occupants.

Smoking is prohibited within all Texas A&M owned and operated buildings. Further support indoor air quality by posting permanent signage prohibiting smoking within 25 feet building air intakes, operable windows, and entrances. Prescribing criteria for exterior smoking spaces in this way aligns with Texas A&M's objective to develop appropriate facility performance criteria that align with the prerequisites of LEED 2009, LEEDv4, and SITES.

Provide Controllable Lighting and Thermal Comfort Systems:

Having the ability to control one or more of an environment's thermal comfort factors and lighting systems to meet individual or group preferences tends to increase occupants' satisfaction with the indoor environment's thermal and lighting characteristics. Work to provide lighting controls to 90% of individual occupant spaces such as private offices and workstations and 100% of multi-occupant spaces such as conference rooms and classrooms. Consider dimming functions and task lighting in individual occupant spaces and multiple switches in multi-occupant spaces to support groups in creating varied lighting environments. Controls can be linked to daylight and occupancy sensors to maximize efficiency but should allow occupant override. When possible, allow building occupants to control the thermal properties of their environment through operable windows, ceiling fans, and thermostats. Install heating and cooling systems that can be regulated on a room-by-room basis through operable vents, fans, and radiators adjusted by occupants. Provide 50% of single-occupant spaces and all multi-occupant spaces with thermal comfort controls.

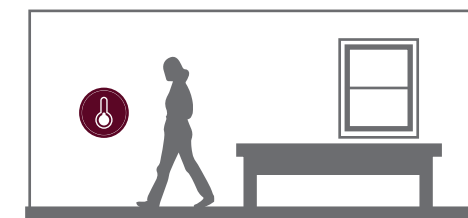

Aim to provide thermal comfort controls to 50% of single-occupant spaces and all multi-occupant spaces via thermostats, operable windows, ceiling fans, or other methods.

Provide Regularly Occupied Spaces with Access to Daylight and Views

Students in classrooms with increased window area and daylight have been found to have 7% - 18% better performance on standardized tests than those without. Serving lighting needs with daylight to the extent possible also reduces energy costs for electric lighting, but must be carefully controlled to minimize undesirable solar heat gain. Work to provide access to views to 90% of regularly occupied spaces by orienting projects to take advantage of consistent midday sunlight and centralizing circulation and service spaces in the light-locked core of buildings. Skylights, atria, and tubular redirection devices can bring light to the center of deep floor plates. During a project's design development phase, require the design team to model daylighting to

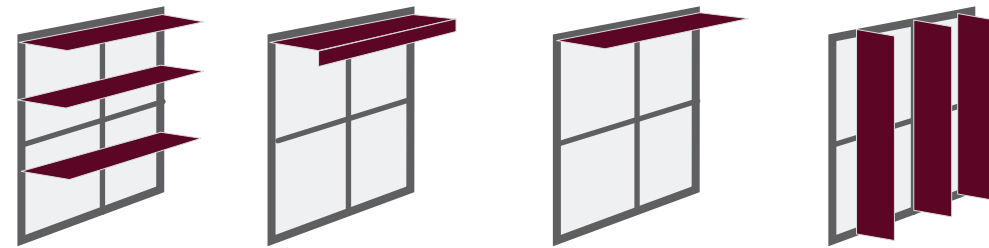

Exterior Daylight Controls

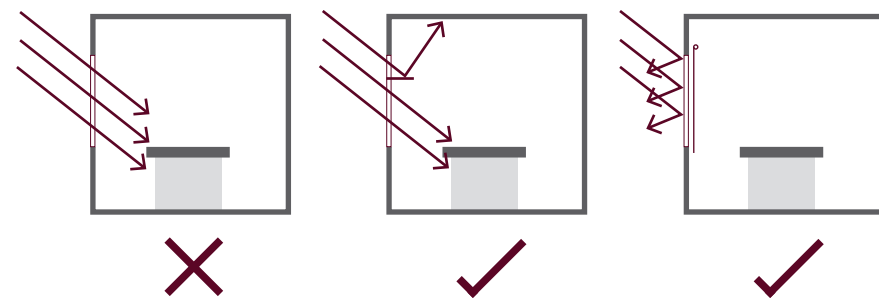

Interior Daylight Controls

While daylight has many benefits, it must be carefully controlled to minimize glare potential and overheating. Exterior shading devices are most effective at limiting overheating, but interior systems can bounce light deeper into building floor plates. Roller shades allow maximum occupant control, but should be tied to building management systems when possible as people remember to pull shades when lighting conditions are unfavorable, but rarely remember to put them back up when great daylight conditions return.

understand how daylight will meet lighting needs before construction. A well-daylit building should have spatial-daylight autonomy (sDA) for at least 55% of the regularly occupied floor area.

Provide an Acoustically Appropriate Environment

An acoustically appropriate environment will support acoustical privacy and speech intelligibility while minimizing noise from equipment and other sources.

Acoustical privacy is especially important in open office areas. In lieu of sound-isolating partitions to minimize noise translation, adequate areas of soft, absorptive materials can provide the desired privacy. For extreme circumstances, mechanical white noise machines can also be considered.

In flexible classroom spaces that support multiple teaching formats speech intelligibility is particularly critical. Spaces that support good speech intelligibility typically have a mixture of both soft surfaces that absorb sound and hard surfaces that reflect sound. Work to provide a total surface area in each classroom that is finished with materials having a noise reduction coefficient of 0.70 or higher that is equal to or greater than the square footage of the room. Generally speaking, when a speaker addresses an audience in an auditorium setting, soft surfaces tend to be located on the wall furthest from the speaker while a mixture of hard and soft surfaces are useful on the perpendicular walls. The wall behind the speaker is typically a hard surface. Flexible classrooms may require input from an acoustical engineer to ensure speech intelligibility regardless of setup.

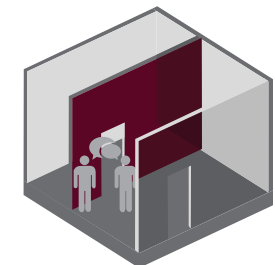
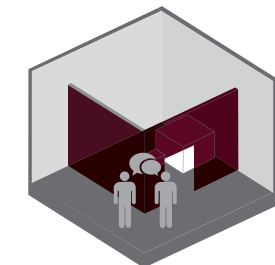
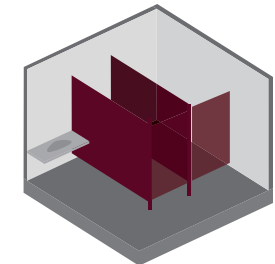
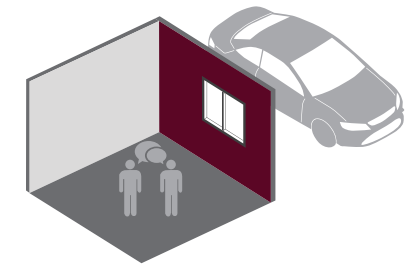

Acoustical privacy can be achieved by meeting specific Sound Transmission Class (STC) ratings for assemblies. The STC ratings of the assemblies highlighted above have a significant impact on whether the adjacent spaces provide sufficient acoustical privacy.

WASTE MANAGEMENT

Waste management coordinates what happens with materials and products when their useful service life has ended and works to reintroduce them to material cycles via recycling and composting in lieu of disposing of them in landfills. The daily operations of campus produce significant quantities of dining services and office wastes while special events create a unique environment that stresses waste management infrastructure with the volume of materials generated in short timeframes.

Target Net Zero Waste

A major shift in waste management occurred in fiscal year 2011 when Texas A&M began providing their own waste management services instead of outsourcing to a vendor. When working with the outside vendor, diversion rates averaged approximately 8%. Now, in 2016, Texas A&M can demonstrate over 70% waste diversion. The increase in diversion is a significant accomplishment, but the total volume of waste generated has also increased significantly. Processes and procedures that prioritize source reduction on campus and divert waste from landfills will support Texas A&M in growing the size of its campus community without growing its waste footprint.



Campus dining is one of the largest contributors to the waste stream in daily campus operations, contributing both pre-consumer waste in the commercial kitchens that serve campus as well as post-consumer waste in the dining rooms. To address pre-consumer waste, on-campus dining currently composts pre-consumer food waste and recycles used cooking oil and waste grease. To cut down on the amount of waste that must be managed, analyze dining services purchases to understand if there are purchasing overages that could be minimized. If present, removing this waste source would decrease the amount of pre-consumer food waste to be composted and improve dining's profitability. Programs for cooking oil and waste grease recycling should quantify their positive impact and look for opportunities to increase their diversion rates. In addition to expanding these strategies across all food

distribution points on campus, dining services should look to increase bulk purchasing in lieu of individual single-serving or small-production purchases to minimize the amount of packaging waste that purchases bring to campus.

Post-consumer wastes from campus dining are currently managed via recycling. While trayless dining has cut down on water wastes for dine-in eating, other strategies should be investigated to manage solid wastes. Dine-in eating could be incentivized by charging for carryout containers which would likely could cut down on the volume of single-use carryout containers that become waste after a meal. Although recyclable or compostable carryout containers are already used in campus dining to divert these wastes from landfills, compostable flatware and carryout still contribute to the volume of waste that must be managed. While metal flatware and glassware must be cleaned after use, these durable goods have a longer life-cycle than one-time use compostable flatware and minimize waste generation.

To increase diversion, solid waste audits should continue and identify what dominant wastes are being generated from dining services. Dining services should then investigate strategies for source reduction and diversion including:

- Partnerships for donating ordering overages to local food banks
- Collaborations with campus departments that might process or recycle compost on campus to improve soil quality and support landscaping
- Dispensing practices for napkins, disposable flatware, and other on-going consumables. When dispensed individually, diners are encouraged to take just the on-going consumables they need instead of bulk dispensing which tends to increase how much of an on-going consumable a diner takes.
- Incentivizing reusable hot and cold drink containers (ie, beverages are some value less expensive if a diner brings in their own container for refill rather than using a one-time disposable container provided by dining services)



Universal recycling containers support wider use by the campus community because only one behavior must be learned.

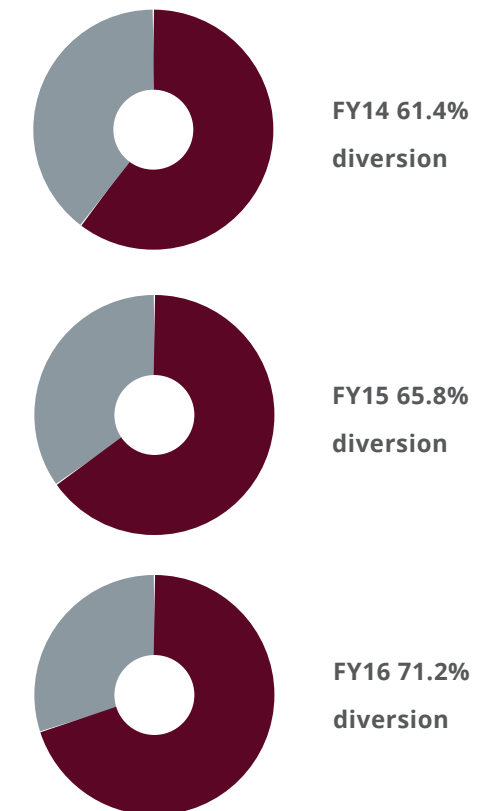

Waste diversion rates are increasing across campus, but so are the total quantities of waste.

Develop A Universal Recycling Program

Recycling is a popular means of diversion, but containers across campus are not uniform and require the community to learn multiple behaviors to appropriately recycle. Studies show consistent, positive messaging about recycling significantly impacts behavior, and encourages people to divert their wastes. Campus is moving toward standardized recycling containers to make them easier to identify and increase convenience for users. Focus messaging on where wastes end up to reinforces the lesson that there is no “away.” A landfill is a real place. Indicating that wastes thrown into a particular container end up there instead of recycling or compost can encourage people to divert their wastes. Past experience and industry input, lead the University to maintain multi-stream recycling, rather than single-stream.

Universal recycling is beginning to rollout across campus and changes are anticipated in 2017 and beyond. Ensure containers have sufficient coverage across campus including public areas in student housing buildings, staff offices, dining facilities, academic spaces, and outdoor areas. Verify container sizing and collection frequency are sufficient to meet the anticipated need. Universal recycling also supports less intensive operations and maintenance because all containers would use the same liners, minimizing attic stock of on-going consumables, and less variation in how waste containers are to be serviced. Simplifying recycling on campus will encourage greater use.

Address Campus Events

Campus events such as football games, commencement, and student move-in/move-out generate unique waste stream conditions. Campus resources to support waste management typically are sized and staffed to support normal usage and large-scale events can stress those resources. SSC and UES both increase staffing for tailgating operations at games to handle the increased in solid waste and recycling. Athletics contracts separately for recycling at Kyle

Field and other athletic venues. Large events bring many visitors to campus who will be more likely to divert their wastes if there is a universal recycling system. Universal recycling assists regular campus users too, but will most support incidental campus visitors - it is unreasonable to expect visitors to learn multiple strategies for recycling.

Student move-out generates wastes such as furniture, clothing, and other durable goods. Texas A&M partners with local charities to accept donations during move-out and make diversion of reusable goods easy for students and parents. Residence Life promotes these donations. Assess if current programs meet demand and expand partnerships if necessary. Move-in generates cardboard and other wastes. UES holds a major cardboard collection event during move-in. Verify that cardboard recycling is easily available, with sufficient capacity in close proximity to residence halls to support diversion. Coordinate the location of donation stations and cardboard recycling efforts with parking to make them as easily accessible as possible. UES or BVR supply recycling containers for many other events during the year.

Construction is an on-going activity that generates significant wastes. Many construction wastes including concrete and other building supplies can be diverted from landfills. Texas A&M uses recycling-focused demolition contractors on large projects, and over 90-percent of construction and demolition waste since 2011 has been recycled. Develop specific diversion targets for contractors to ensure they support Texas A&M's waste goals. Surplus office goods generated by renovation and relocation are managed by the Surplus Property Office which preferences resale within the University and state agency communities and keeps usable goods from going to landfills. The Office recycles pallets and metals through local recyclers, and nearly 100-percent of university electronics through public school donations, or the Texas Criminal Justice Department's repair/recycle program. Verify this office's space is sufficient to meet demand and expand the office if necessary.



Campus events create unique waste environments that stress waste management resources.

SOCIAL SUSTAINABILITY

Social sustainability has historically been the least defined aspect of sustainability. Generally, social sustainability is the idea that future generations should have the same or greater access to social resources as the current generation (inter-generational equity) while there should also be equal access to social resources within the current generation (intra-generational equity). Texas A&M University's understanding of social sustainability falls within this broad definition and targets efforts related to diversity, inclusion, equity, and physical and mental health. As Texas A&M's community becomes more diverse, it becomes increasingly imperative to promote responsible stewardship of fiscal, natural, and human resources.

Support Diversity, Inclusion, and Equity

Texas A&M University was founded in 1876 with an all-male, all-military student body. While the core values of excellence, integrity, leadership, loyalty, respect, and selfless service that define the Texas A&M University community have not changed, the composition of the student body, faculty, and staff has evolved to include a broader social and cultural diversity that is increasingly representative of Texas and the United States. There is much to celebrate in Texas A&M's historic legacy and much to do to support diversity, inclusion, and equity across the changing makeup of campus.

The Office for Diversity last assessed the campus climate on diversity and related issues in 2013. This reporting gives the University quantitative and qualitative data on behaviors and attitudes worth celebrating as well as those that need attention for a more diverse, inclusive, and equitable future. To continue future development, it is imperative that Texas A&M continue to regularly assess the campus climate on diversity and related issues and develop accountable action plans to ensure that appropriate resources are devoted to these subjects. While faculty and staff may remain at Texas A&M for decades, the undergraduate student population changes almost completely every four years. The campus climate on diversity and related issues should be assessed every three years at minimum to understand

whether campus initiatives are changing perspectives on these subjects during an undergraduate's college experience.

To move the needle on campus climate, the University must continue to engage a broad base of stakeholders in social sustainability discussions. Increasing cultural competence among students, faculty, and staff will require trainings, programs, and activities on diversity, inclusion, and equity as many individuals are unaware that their actions are inappropriate or unwelcome. These actions influence recruitment, retention, and climate. In an ideal world, diversity, inclusion, and equity occur organically, but intentionally increasing cultural competence can also create a network of advocates that will support someone experiencing bias or discrimination.

Many policies, programs, and academic endeavors can support diversity, inclusion, and equity including:

- Affordability and access for low income and non-traditional students
- Discrimination response mechanisms such as Stop Hate and Tell Somebody to serve those who have experienced an act of bias
- Programs designed to recruit students, faculty, and staff from underrepresented groups
- Formal and informal mentoring programs for students, faculty, and staff
- Pay equity, fair wages, and benefit policies
- Hiring and recruiting best practices and processes
- Research that impacts social, cultural, health, and economic disparities
- Unit accountability measures, practices, and processes
- Teaching and learning innovations that increase cultural competence
- Transformational educational experiences
- Intergroup dialogue
- Public partnerships and outreach
- Access to intergenerational care co-located with campus
- Amenities that reflect the student population (current and future)
- Campus design that supports interaction and engagement

Social Sustainability Terms

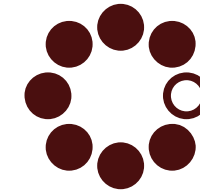

Diversity

The process of recognizing our differences and similarities.

Inclusion

Creating an environment and system that capitalizes on these differences and similarities.

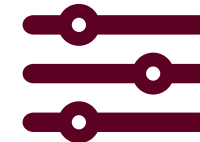

Equality

The state or quality of being the same.

Equity

The state or quality of being fair.



Social Justice

The view that everyone deserves equal economic, political, and social rights and opportunities.

Environmental Justice

The fair treatment and meaningful involvement of all people with respect to the development, implementation, and enforcement of environmental laws, regulations, and policies.

Texas A&M's Diversity Plan focuses on accountability, climate, and equity efforts and should be read in tandem with the operational recommendations outlined above.

The implementation of universal design standards that support those of all abilities in using University facilities will have built implications. To the extent possible, Texas A&M should work to renovate existing facilities and require new facilities to include:

- Equitable ground level entrances without stairs
- Interior doors, hallways, and alcoves that support mobility for wheelchair users
- Exterior ground surfaces that support mobility for wheelchair users
- Lever handles for operable doors rather than twisting knobs
- Lighting and thermal comfort controls that do not rely on fine motor control
- Redundant information in both auditory and visual formats
- Meaningful icons in signage
- Intuitive circulation to minimize the need for directional signage
- Volume, speed, and language control on auditory information
- Clearly labeled equipment controls
- Signage indicating accessible building entrances should be sited in clear and consistent locations. See Chapter Eight, Signage and Wayfinding for further details.
- Campus alterations should be coordinated with the Texas A&M Windchime Initiative, to ensure that campus remains navigable for the visually impaired.

As the campus environment evolves to include additional amenities, efforts should be made to represent a broader cross-section of students, faculty, and staff in both exterior and interior public art; it is challenging for underrepresented members of the campus community to feel valued and included when their social and cultural identities are not reflected in the institution's public image. Texas A&M might also consider preferred walking routes that include interpretive signage celebrating the evolution of social and cultural diversity that will be Texas A&M's legacy.



While Texas A&M's core principles have remained the same, the campus community is growing to include a broader range of social and cultural diversity that is increasingly representative of Texas and the United States.

Support Physical and Mental Health

Providing a campus environment that adequately addresses physical and mental health responds to the overwhelming evidence that the design of educational environments impacts the health, well-being, and productivity of students, faculty, and staff. Texas A&M University's campus can promote increased activity in the outdoor environment by ensuring that each character zone provides walkable access to a variety of uses. Walkable access will allow for incidental physical activity in daily life and limit the demand for transit infrastructure to support longer trips within the day. Efforts should also be made to include green space, walking and biking paths, transit stops, and recreation opportunities in each of the character zones. Walking paths can be tied to other social sustainability objectives as previously mentioned.

Within campus buildings, physical activity can be increased by focusing vertical circulation designs on stairs rather than elevators. Locate appealing, visible stairs on a building's principal paths of travel from the main entrance while making elevators easily accessible for those who require them. Support designs that allow regularly occupied spaces access to daylight and views, and design visual appealing environments along paths of travel. Provide end-of-trip facilities for bicycle travelers such as showers and locker rooms and consider opportunities to provide small-scale exercise spaces within buildings.



Other infrastructure considerations for physical health on campus include the placement and scale of on-campus student health services. Presently located in Beutel Health Center, the existing facility serves 500 students per day across a variety of services. As the campus population grows, health services must scale to meet demand and their current location may not be the most appropriate future home - it has limited parking and two-thirds of patients come from off-campus. Providing sufficient parking for those who access health services could help stem the flow of illness in future as many may currently be either walking or using the bus to access the health center, potentially exposing a larger number of the campus community to illness.

Developing a more pedestrian-oriented campus in the area of Beutel Health is in conflict with this service's access requirements. Emergency vehicle access to Beutel Health Center is required, but may not be desirable in an intended pedestrian-focused area. To support physical health, consider where student health services will be located in future, what scope it will require to serve a growing campus population, and whether it should be co-located with mental health facilities and/or other amenities.



Signage indicating preferred walking routes and distances could better support physical activity on campus and highlight underrepresented campus accomplishments.

Trails and Primary Linkages

-  Walking Trails
-  Multimodal Paths
-  Primary Pedestrian Linkages

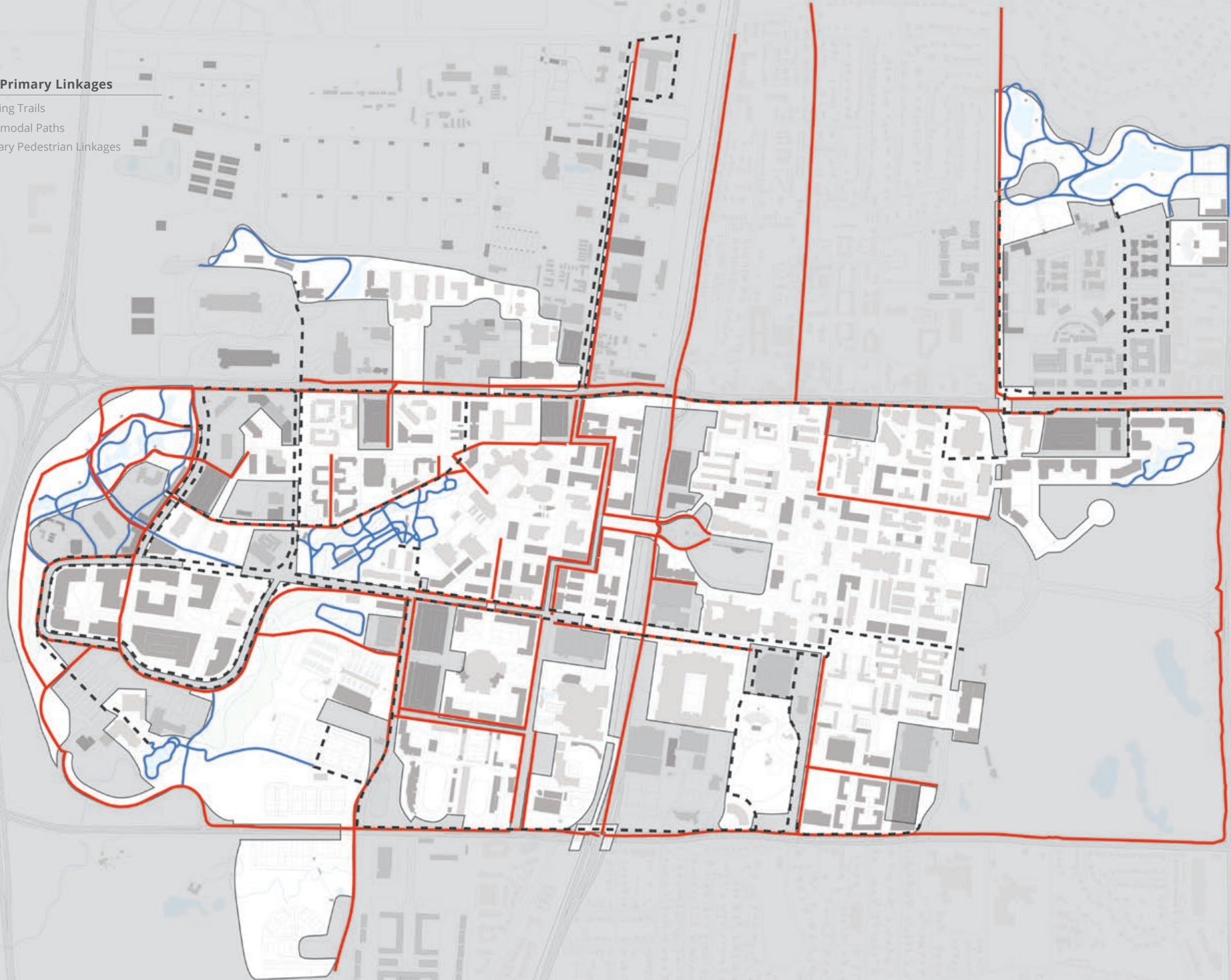







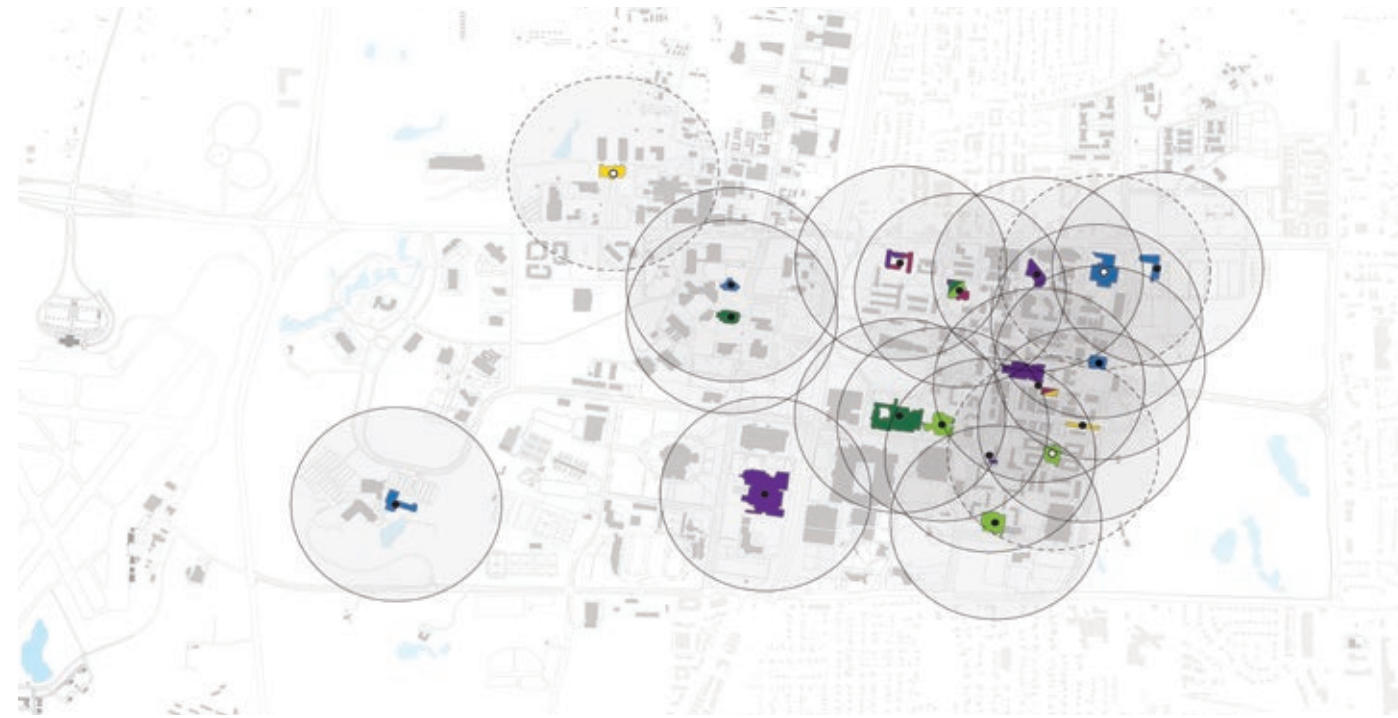

On-campus access to dining is insufficient to meet current and projected needs. Full-service dining is only accessible to a small percentage of campus within a ¼ mile walking radius, which creates numerous food deserts. Hours of operation create additional food deserts. Work to develop additional opportunities for full-service dining to increase equitable access to food on campus. Within campus dining options, ensure healthy food options are available that meet a range of dietary restrictions and choices. To the extent possible, preference local and organic produce as well as local and humanely treated meat and dairy products.

In addition to equitable access to food options, the campus environment should evaluate the availability of water fountains in the public realm. To support pedestrian and bicycle travelers in College Station's warm climate providing easy access to water will keep people hydrated and support health.



Mapping dining on campus demonstrates that food deserts, areas where food is not available within a 1/4 mile walking radius, exist on campus. Western areas of campus are disproportionately affected.

Existing On-Campus Dining

-  EXISTING FACILITY:
5-MINUTE WALK RADIUS
-  TEMPORARILY OFF-LINE FACILITY:
5-MINUTE WALK RADIUS
-  CONVENIENCE STORE
-  FOOD COURT
-  BUFFET STYLE
-  KIOSK
-  CAFE

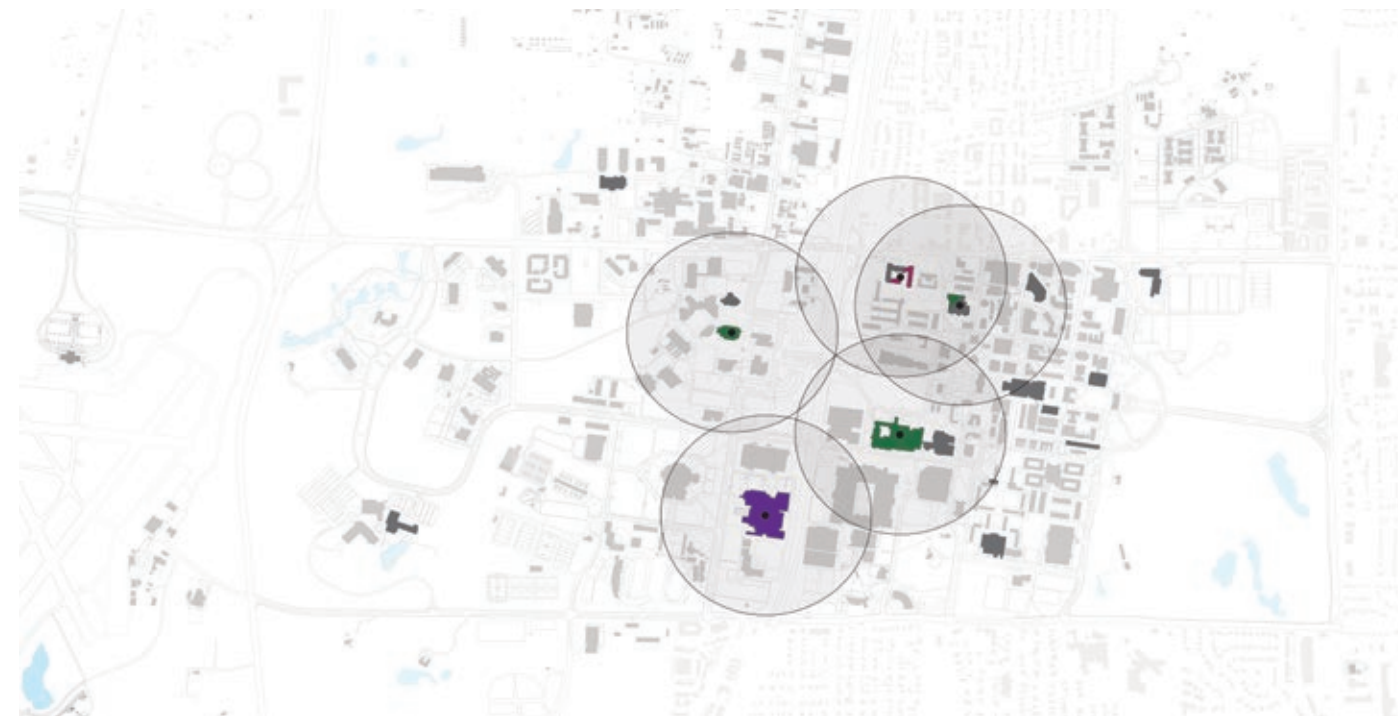

At 6:00 pm on Saturdays, access to dining is more challenging than the food desert map suggests as not all facilities have the same hours of operation. At 6:00 pm on Saturday, many facilities are closed and options are limited, particularly for on-campus residents.

EDUCATION, OUTREACH AND ENGAGEMENT

To celebrate existing achievements, gain new followers, and spur further initiatives, Texas A&M University will develop a robust education, outreach, and engagement program for sustainability. Since its inception in March 2008, the Office of Sustainability has engaged the Texas A&M community through on-campus programming to educate students, faculty, and staff about green practices. The Office also offers the Sustainable Office Certification to support on-campus departments in documenting their progress toward institutional goals and is responsible for STARS reporting. Sustainability touches all aspects of campus life and many university departments influence Texas A&M's ability to achieve its stated sustainability vision: Every member of the Aggie family works together to champion environmental stewardship, encourage healthy living, and improve social and economic opportunities and outcomes locally, nationally, and globally.

Each university component must understand how their actions contribute to the overall sustainability of the institution and play into public reporting mechanisms. The Marketing & Communications Office will work with the Office of Sustainability to develop a cohesive communications plan that allows all contributors to university sustainability to verbally and graphically represent high-performance achievements using similar language and images. In addition to print and digital media, this also includes interpretative signage that will educate students, visitors, faculty, and staff about sustainability initiatives at work across campus.

PEDAGOGY, RESEARCH AND INNOVATION

The Office of Sustainability stated in the 2015 AASHE STARS report that 738 sustainability courses are offered on campus. Texas A&M University recognizes its campus environment and building assets as extensions of the classroom that offer hands-on research and educational opportunities and looks to fund investments in the built environment that support pedagogical goals for sustainability research and education.



Office of Sustainability interns pause from talking about ways to make campus more efficient to pose with Reveille IX at Campus Sustainability Day 2016.



Campus Sustainability Day features many outreach opportunities.



Geosciences was one of the pilot offices to achieve the Office of Sustainability's Sustainable Office Certification.



Tours of local recycling facilities such as the Halloween tour of the Brazos Valley Recycling Center pictured above introduce students to how sustainability impacts our world.

ADMINISTRATIVE SUPPORT

As the University's commitment to sustainability grows, administrative coordination will scale appropriately. Texas A&M will look to invest responsibly in sustainability initiatives, balancing the first costs of strategies and initiatives with their long-term financial paybacks and educational opportunities. The University will continue to leverage its purchasing dollars to encourage sustainable goods and services. To date, the University has benefited from campus-wide green housekeeping strategies and is working to develop and implement a Vendor Code of Conduct that will support sourcing goods and services with improved performance measures. Planning for sustainability will evolve the work established by the 2010 Sustainability Master Plan, Office of Sustainability Biennial Reports, and STARS reporting. Lessons learned since the 2010 Sustainability Master Plan suggest biennial reporting and annual STARS reporting overtax existing resources with relatively redundant communications tools. The Office of Sustainability intends to more robustly use STARS reporting in future with smaller infographic reports for campus updates and coordination. The 2017 Master Plan process has also made it clear that it is time to update the 2010 Sustainability Master Plan to align with the current campus climate on sustainability.

The President's Sustainability Advisory Council as well as other efforts will coordinate the broad base of campus stakeholders to optimize decision-making and capitalize on the synergies that could happen across campus departments. Comprised of students and faculty across campus, the President's Sustainability Advisory Council will be tasked with supporting the Office of Sustainability's STARS reporting and report annually to the University President on institutional progress on sustainability initiatives. This newly formed group will continue to evolve as an updated Sustainability Master Plan becomes available.



Integrated into curricular experiences, sustainability prepares students for professional work in growing career fields including energy, resource management, architecture, and engineering.







06

CAMPUS GUIDELINES

Introduction

Aspirational Values

Integrated Approach to Guidelines

Planning and Architecture Guidelines

Site and Landscape Guidelines

Plant List



The composition of the Texas A&M University campus spans 140 years of growth and development. The campus is a place with a lasting presence, and decisions about the built and natural environment contribute to continuing this legacy.

The intent of the Campus Guidelines is to support the ongoing development of a high-quality built environment and campus experience, while preserving its legacy buildings and open spaces.

With great prominence, the campus showcases a significant set of historic buildings and civic spaces that form a visual identity for the core of campus. While this visual identity in the core of campus lends itself to a traditional perception of the campus, the reality of the entire campus reflects a much greater diversity in its built environment. The University faces a complex challenge: Leverage the long and historic heritage as an expression of its institutional identity through existing buildings and grounds, while also allowing ongoing design and construction to meet the evolving needs of a 21st century campus.

A successful higher education campus should be designed to support the needs of the students, faculty, staff and community in which it serves. As such, the campus must address and respond to diverse scales, functions and programs over an extended period of time. To achieve this, the Campus Guidelines support a diversity in the built environment with broader planning,

architectural and landscape expressions, rather than simply prescriptive and historicist based guidelines. This chapter outlines a course of action to guide the design of Texas A&M's grounds and building. These guidelines are not intended to prescribe solutions nor limit creativity, but rather establish a framework of design practices that respect Texas A&M's past and addresses its current challenges, while being inventive in establishing its future.

To address the issues of the variable size and nature of campus along with the diverse built environment of campus, the Campus Master Plan organizes the Campus Guidelines into a hierarchy of principles to which proposed projects must demonstrate conformance. The Guidelines address more than simply buildings and open spaces; they extend to provide a range of development parameters for all projects types across the entirety of campus. Under this approach all campus projects including buildings, plazas and landscape improvements, civic open space, public art, signage, service functions, support facilities and other infrastructure are influenced in the Campus Guidelines.

The Campus Guidelines establish a toolkit to guide consultants and staff to appropriately incorporate the expectations of the University into the creation of a cohesive built environment. The chapter does not prescribe specific design mandates for the campus but, rather, establishes a design direction and performance objectives for future campus development. Interpretation of the guidelines and approval of proposed projects continues to remain vested in the Council for the Built Environment, its sub-councils and the Office of the University Architect.



The Campus Guidelines

address a range of scales influenced by sustainable considerations such as building orientation and plant selection. Aesthetic preferences are articulated that prioritize high-performance buildings and landscapes that are both attractive and functional campus amenities.

VALUES OF THE PHYSICAL ENVIRONMENT

The Values of the Physical Environment reflect the aspirational objective that links the institutional enterprise to its physical manifestation. These values stem from the *Strategic Plan: Vision 2020* and *Academic Master Plan: Accelerating Excellence* to direct how physical components included in the Campus Guidelines supports and enhances the Mission and Core Values of Texas A&M University.

As the campus continues to develop, these aspirations serve as a continual check to gauge if development is proceeding along a path that embodies the values and reflects the vision of the University. They also serve a daily role in evaluating proposed projects. Individual projects are expected to embody these values in all aspects of their process, design and realization. As projects are reviewed for approvals, a starting point for evaluation is to understand how these values have been incorporated into the project and reflect the larger identity of the University.



Memorial Student Center

Enrich the Experience:

By enhancing of all aspects of the University to serve the variety of campus users - including the physical environment, services, teaching and learning, social equity and health and wellness.

Foster Interaction and Collaboration:

By creating spaces and places that promote the exchange of ideas and display academic and research work.

Connect People and Places:

By building a network of physical and social linkages that intuitively foster interactions between campus users and the campus and the community.

Advance Learning and Discovery:

By engaging the campus community through places and buildings, the physical environment is utilized as an instructional and research asset.

Enhance Institutional Identity:

By crafting a consistent and strong campus identity, the physical environment provides a powerful impression that embodies a distinctive regional and global character.

Embrace Tradition and Legacy:

By conserving and honoring the rich history of campus, future generations are able to build upon a living heritage that continues to evolve and respect both past and future generations.

INTEGRATED APPROACH TO GUIDELINES

The 2017 Campus Master Plan encompasses a range of integrated guidelines that support one another in the enhancement of the built environment to continuously improve the campus experience. As shown in the diagram below, this range includes: Planning and Architecture, Site and Landscape, Wayfinding and Signage, and Conservations and Heritage. To reinforce and foster comprehensive and integrated development across the campus, the Campus Guidelines are inclusive of both campus-wide and site/building-specific aspects that address the need to look beyond an individual projects' traditional boundaries.

This chapter focuses on the Planning and Architecture Guidelines and the Site and Landscape Guidelines. Closely integrated, these two parts of the guidelines work together to guide the quality of the built environment and the experience that one has on campus. Both sets of Guidelines work at a variety of scales in order to create a cohesiveness in design that leads to a campus that is unified, but not uniform.

The Guidelines are organized from macro to micro, increasing in specificity: Values of the Built Environment provide the aspirations to all campus development, larger planning concepts are captured in multiple scales including Campus-wide, Character Zone or Precinct Areas, and Site and Building-Specific guidelines establish a consistent campus palette for individual projects.

As with the entirety of the 2017 Campus Master Plan report, aspects of sustainability are integrated throughout. Included in this section are salient points related to components of planning, sites, buildings and landscape. Projects are expected to demonstrate compliance with all aspects of the Campus Guidelines included throughout the Campus Master Plan. Additional chapters for reference and review include: Section 05 – Sustainability and Wellness, Section 07 – Conservation and Heritage, and Section 08 – Wayfinding and Signage.

Campus Scale Reference:

Campus-Wide:

Planning concepts which seek to create a coordinated profile of uses, functions and placements on campus.

Character Zone:

Planning concepts which seek to create coordination between new development and the existing fabric of the campus that has developed over time. Character Zones are organized by physical elements within their boundaries.

Precinct Area:

Design concepts that address specific areas within Character Zones that are tied to a specific program or purpose. ie. Engineering, On-Campus Housing, Corps of Cadets.

Site Specific:

Design concepts and amenities that address a specific site; these guidelines may vary depending on Character Zone or Precinct.

Building Specific:

Design concepts that address exterior building design and how these exteriors relate to both the campus at large and its immediate context; these guidelines may vary depending on Character Zone.

VALUES OF THE PHYSICAL ENVIRONMENT			
	↓	↓	↓
INCREASING SPECIFICITY ↓	PLANNING AND ARCHITECTURE GUIDELINES	SITE AND LANDSCAPE GUIDELINES	CONSERVATION AND HERITAGE GUIDELINES
	CDP ALIGNMENT	OPEN SPACE	PLANNING
	SITE AND CONTEXT	CONNECTIONS	DESIGN AND CONSTRUCTION
	ARCHITECTURAL	AMENITIES	POST PROJECT
	CHARACTER ZONES	PROGRAM	DEMOLITION
	SUSTAINABILITY	SUSTAINABILITY	
	LANDSCAPE CONNECTIONS	MAINTENANCE	
	REFER TO CHAPTER 06	REFER TO CHAPTER 06	REFER TO CHAPTER 07
			REFER TO CHAPTER 08

While each building should reflect its own time and place, they should also reflect the enduring values of elegance, quality and durability - contributing to a coherent and memorable identity for the campus as a whole.

Originated and organized by six key principles, the Planning and Architecture Guidelines, encompass scales of campus-wide planning, precinct and site planning, building-level detail and Character Zone facets while including broad sustainability aspects along with integration to the Site and Landscape Guidelines. This breadth of scale is required to support thoughtful integration of projects beyond their physical boundaries, acknowledging that each individual project is part of a larger system – the campus as a whole environment.

The planning-focused guidelines take as a starting point the Open Space Network and Framework Schema to inform appropriate locations of future buildings and systems. The site and massing focused guidelines provide the link between the planning and building guidelines to inform appropriate siting of buildings and potential program distribution. The building-level guidelines outline components such as entry points and material use. Often, each of these components have unique aspects reflective of their individual Character Zones while still integrated into the larger context of the campus. An overlay of sustainable considerations informs each level of detail. Finally, there is a critical link to the Site and Landscape Guidelines that creates a cohesive built environment.

The six Planning and Architecture principles include:

Align projects, at a campus-wide scale, to the Campus Development Plan.

This principle links the Campus Development Plan with the Campus Guidelines. It identifies applicable planning considerations to ensure project needs are aligned with and supportive of the utilization of resources and integration of systems at a campus-wide scale.

Identify appropriate site and context development patterns.

This principle emphasizes the relationships between the specific project program to its site and context. Integrating development into the fabric of campus requires sensitivity to existing conditions as well as consideration of future opportunities.

Detail the architectural expression of buildings.

Utilizing consistent yet flexible building design parameters, such as facade rhythm and material use, these guidelines create unity and character across the campus that respects its heritage while accommodating evolving program needs.

Recognize distinguishing aspects of campus as reflected in the Character Zones.

This principle acknowledges the presence of significant diversity in the built environment across the Campus and establishes appropriate parameters for integration of projects in the existing context.

Facilitate sustainability at project scales.

These guidelines overlay project-scale sustainability considerations to support high-performance buildings through both passive and active strategies along with integrating campus-wide sustainability initiatives.

Unite the Planning and Architecture Guidelines seamlessly to the Site and Landscape Guidelines.

Interlinking the guidelines contributes to a cohesive and supportive built environment that blurs the boundary between inside and outside.



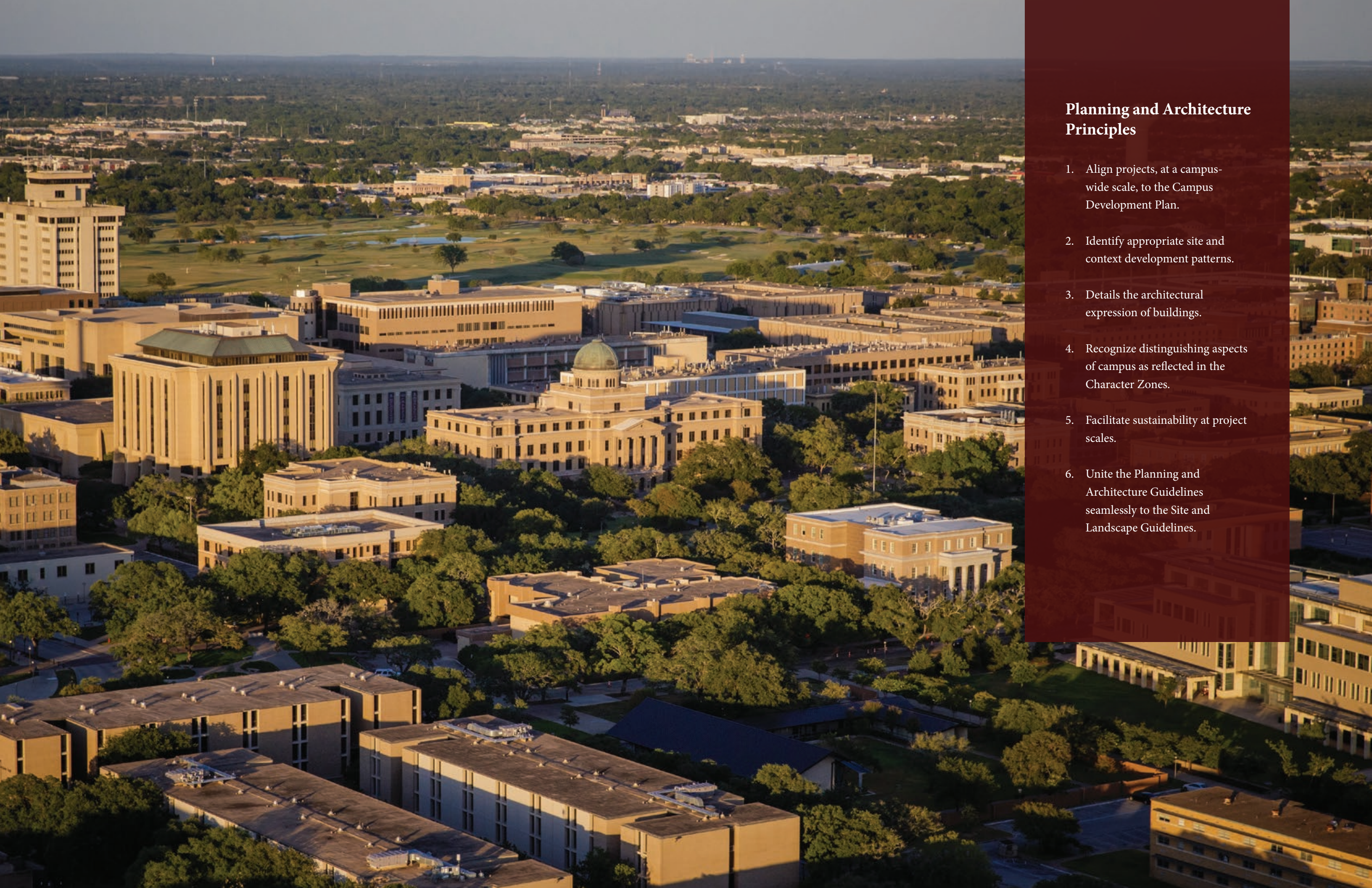

Planning and Architecture Principles

1. Align projects, at a campus-wide scale, to the Campus Development Plan.
2. Identify appropriate site and context development patterns.
3. Details the architectural expression of buildings.
4. Recognize distinguishing aspects of campus as reflected in the Character Zones.
5. Facilitate sustainability at project scales.
6. Unite the Planning and Architecture Guidelines seamlessly to the Site and Landscape Guidelines.

Principle - 01

Project Alignment to the Campus Development Plan

This principle is the initial link, at a campus-wide scale, connecting the Campus Development Plan with the Campus Guidelines. The following guidelines identify applicable planning considerations to ensure project needs align with utilization of campus resources, support stronger cross-campus connections and integrate supporting campus infrastructure. Guidelines forming part of Principle – 01 include:

- 1.1 Program & Use Distribution
- 1.2 Signature Buildings & Sites
- 1.3 Community Access
- 1.4 Framework Alignment
- 1.5 Open Space Network
- 1.6 Pedestrian Connections
- 1.7 View Corridors
- 1.8 Mobility Integration
- 1.9 Infrastructure Support
- 1.10 Service Consolidation

1.1 - PROGRAM AND USE DISTRIBUTION:

The size and variable character of the campus presents numerous options for the distribution of uses and programs across its extents. In the past, this has allowed low-density development that created isolated pockets of programs not well connected into the overall campus context. Current trends have seen a tendency to segregate similar programs into consolidate locations.

Moving forward, the Campus Master Plan supports the intermixing of compatible programs and use to support interdisciplinary learning and discovery. This intermixing can encompass: greater variety in the distribution of uses across campus; co-locating multiple units within a location to allow for integrated instruction and research across disciplines; housing multiple compatible space types within a building such as instructional space, student support, research, wellness and dining; or other variations of intermixing of programs and uses.

Selection of project locations should demonstrate synergies and intermixing of use profiles with the larger campus context and within individual project programs. This intermixing directly reflects the first four Values of the Built Environment.



The Corps of Cadets Leadership Learning Centers encourage non-Cadets to use the Corps of Cadets precinct for academic needs and social interaction.

Currently, recreation and wellness uses are primarily located in a single location – the Student Recreation Center. While located in what is approximately the geographic center of the Campus, it is difficult for patrons to readily access the facility. For example, it is located outside of the 10-minute walking radius of all the primary on-campus housing locations. Consideration should be given to distribute these types of uses across campus to better support the campus community.

The recently completed Leadership Learning Centers in the Southside Character Zone illustrate a good mix of uses with the facilities with spaces for dining, student success, office and other collaborative type spaces. The Leadership Learning Centers have brought together constituents from across the campus who seek to utilize the variety of spaces and interact with others from the campus.

The proposed Campus Forums, discussed in Chapter 03, organize various uses into a network of active and vibrant spaces across the campus that support the academic enterprise. This network promotes the exchange of ideas, display of academic and research work and fosters interactions among the campus community.



As a proposed Campus Forum, the West Campus Pavilion provides a central location to interact, and promotes interdisciplinary learning and discovery.

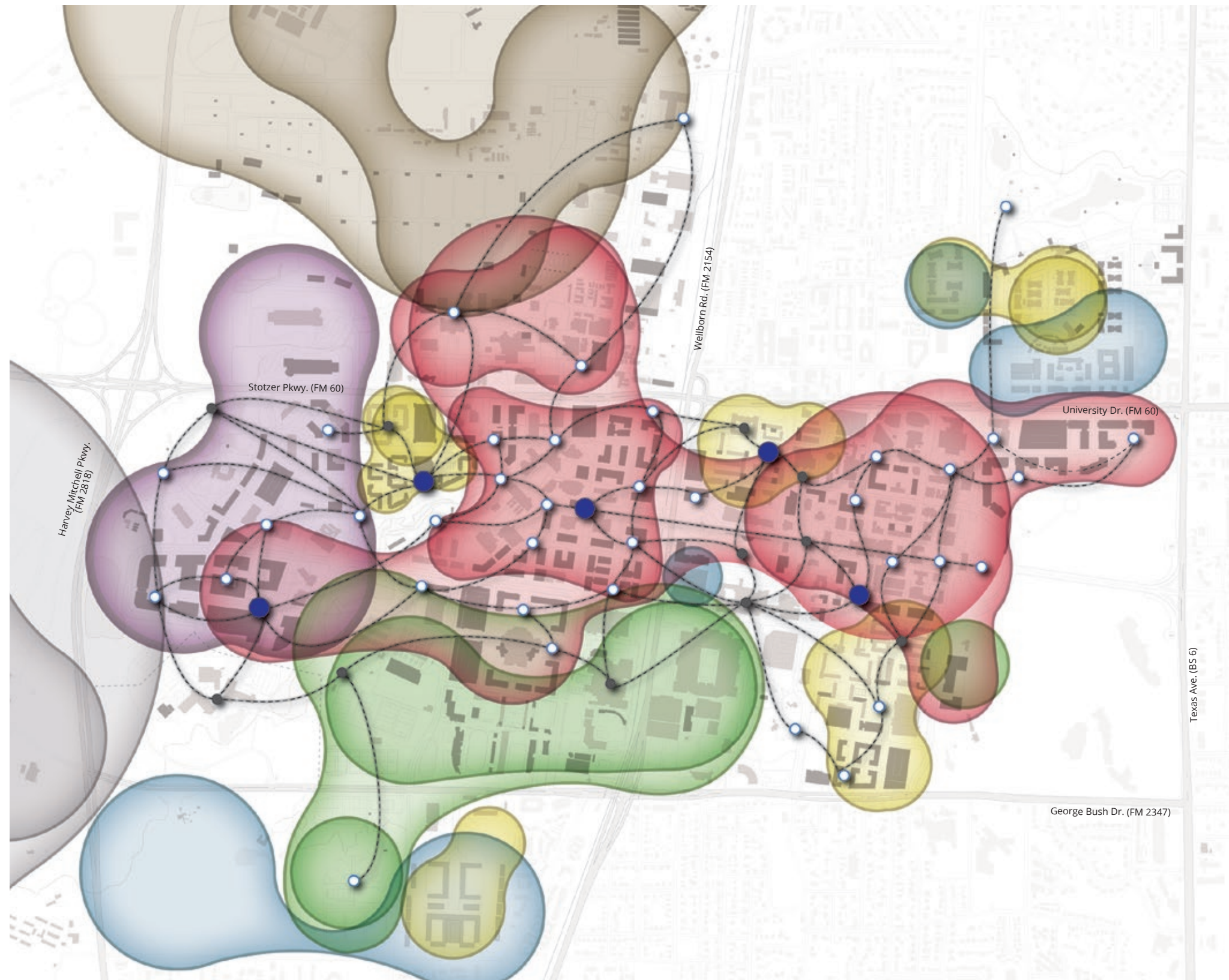

Use Amoebas overlaid on the Campus Development Plan illustrates the distribution of space on the campus.

The overlay of the proposed Campus Forum network illustrates the potential for linking constituents with uses.

Primary Building Uses (Amoebas)

- Academics
- Housing
- Athletics/Recreation
- Research
- Bush School/Library
- Agriculture
- Partnerships
- Airport

Campus Forums

- Planned Forum Project - Near term
- Existing Forum Space
- Planned Forum Project - Long term

1.2 - SIGNATURE BUILDINGS AND SITES:

Particular buildings and sites serve an important role in the place-making and identity of the campus, strengthening the overall fabric of the campus context. Two aspects, the building program and the site location, often distinguish signature prominence on the campus. The two aspects can work separately or in conjunction with one another.

For programs, buildings that serve a campus-wide or public can often fall with the signature building category. These programs serve a wide audience and support the institutional enterprise in multiple roles. Buildings that house libraries, museums or prominent academic programs may qualify as signature buildings.

Existing examples on the campus include Kyle Field for its hosting of games and special events, the Memorial Student Center which houses a variety of programs including campus galleries, Evans Library which is the primary library for the campus.

The location of signature buildings and sites is often defined by identifiable criteria including alignment along the Campus Framework, major components of the Open Space Network or campus edge conditions that serve as physical or visual gateways.

Existing examples based on location include both the Academic Building and the Jack K. Williams Building that are located along the main central axis of the campus. This includes opens spaces such as Military Walk and Simpson Drill Field.

Future campus development should give thoughtful consideration to programs and location to properly align signature buildings and sites that will reinforce and enhance both the campus experience and the campus identity.



Signature Building - Academic Building



Signature Open Space - Military Walk

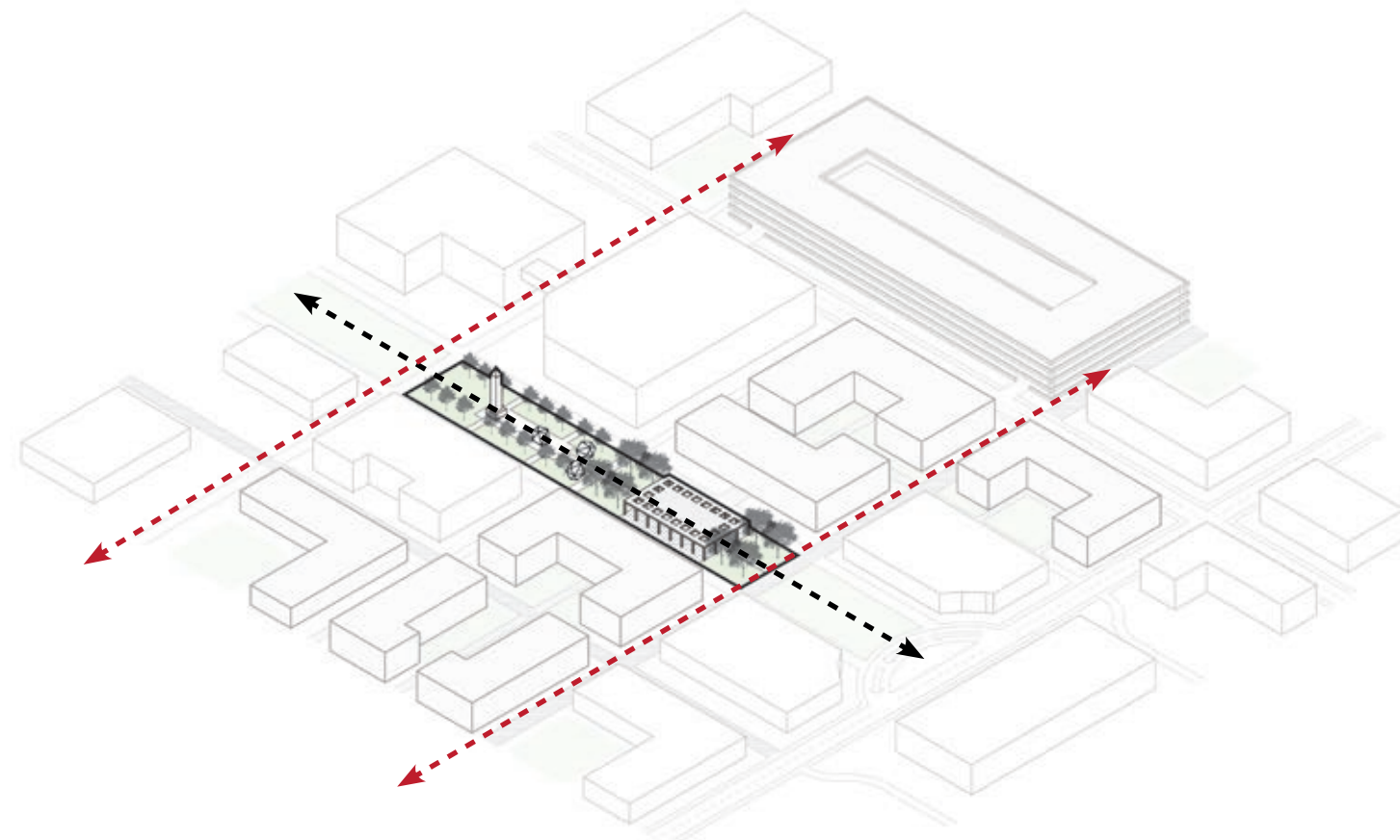

Signature site located along the Framework Schema within a prominent quad of the Open Space Network containing buildings housing a variety of programs serving a campus-wide constituency.

1.3 - COMMUNITY ACCESS:

The proposed project strengthens opportunities for off campus visitors and the broader community to participate in on-campus events, accessing shared resources and engaging in the University's enterprise.



Event - Spirit Walk



Shared Resources - Hensel Park

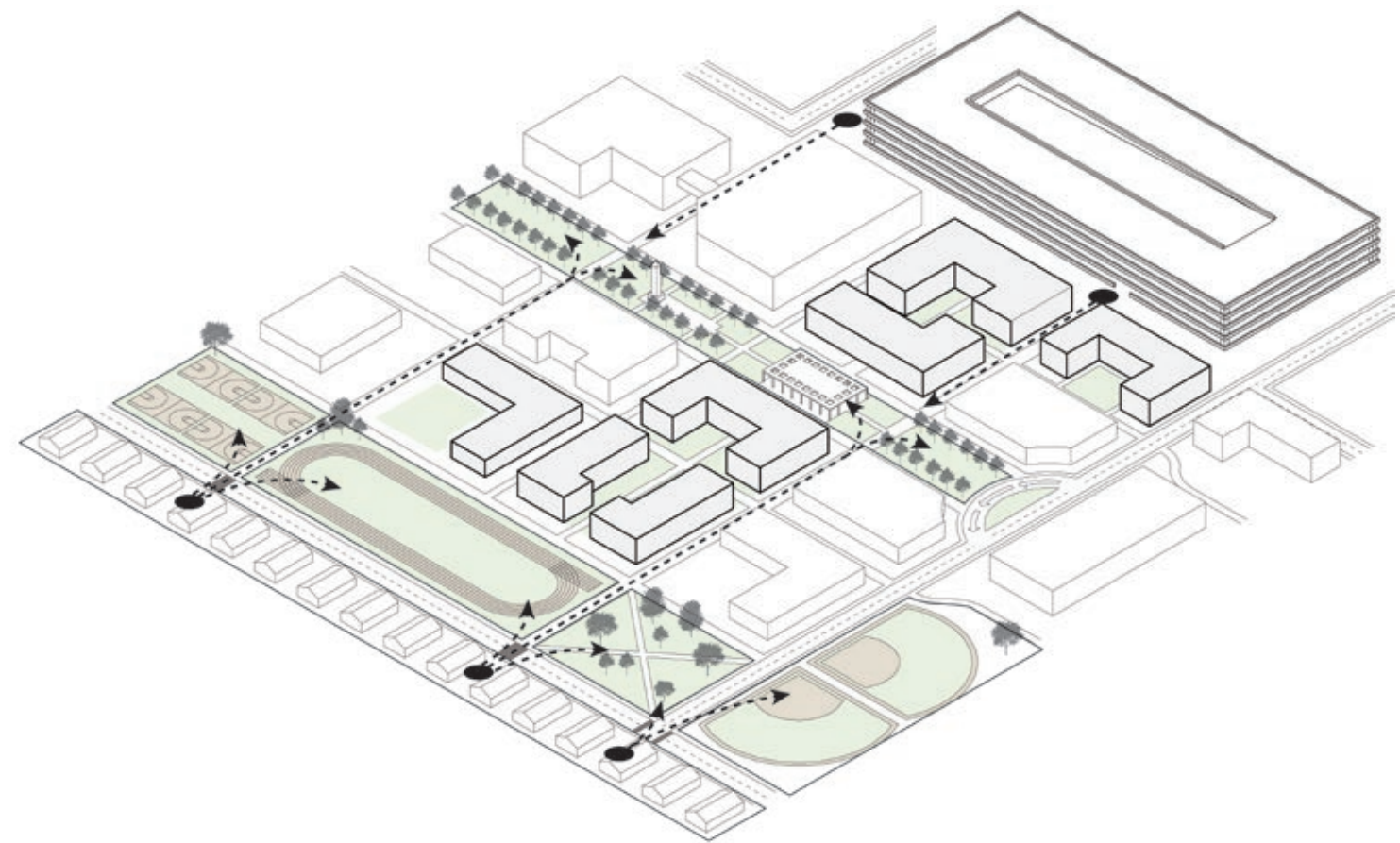

Welcoming entries, ease of access and clear wayfinding facilitate the connection between the community and campus.

1.4 - FRAMEWORK ALIGNMENT:

Projects should align with campus-wide growth patterns by utilizing the Framework Schema, which is a conceptual diagram that identifies the key linkages and connections across campus. The proposed position of new buildings and additions should create long-term synergies with existing facilities, support neighboring uses, and align with existing site context. Buildings should engage and define streets, pedestrian paths, and open spaces through siting, massing, continuity of facades, and appropriate points of entry. In terms of future growth, an emphasis should be placed on linking the campus' north and south edges to better define the edges of the campus and their relation to the surrounding community.



Central Campus Axis at New Main Drive



Enhanced Landscape at Evans Library to Strengthen Framework



Framework Schema - See Chapter 03

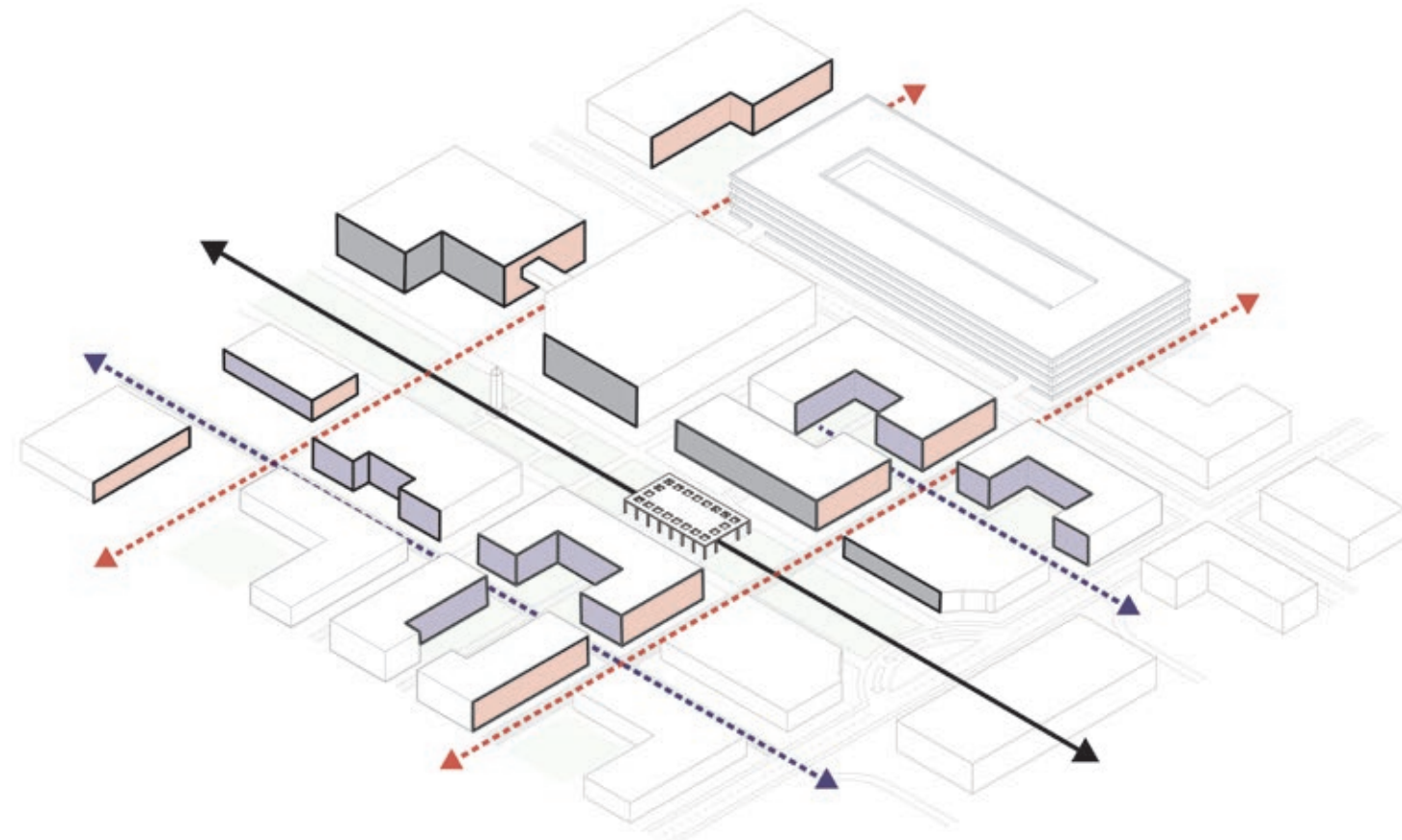

The Framework Schema identifies prominent existing and proposed axial connections on campus that support strengthened linkages across the physical extents of the campus.

1.5 - OPEN SPACE NETWORK:

Illustrated through the Open Space Network, campus development and growth will be guided by the creation of new open space and the enhancement of existing open spaces to support an enriched and cohesive campus experience. Projects should support existing open space patterns, repair dysfunctional patterns and create new pedestrian environments.

New buildings or additions in underdeveloped Character Zones, such as West Campus and Research Park, should include open spaces such as malls, quadrangles, courtyards and pocket parks in order to convert the existing suburban development patterns into an urban and organized structure.

New buildings or additions in developed Character Zones, such as Historic Core and Northside, should preserve existing open space and create new open space that is contextually appropriate size, scale, orientation, and materiality, with a focus on the spaces in between buildings.

To achieve an expanded and enhanced Open Space Network, the Landscape Guidelines identify primary uses for spaces (programs) and the necessary physical characteristics to support these uses (amenities) to ensure active, and cohesive open spaces throughout the campus.



Open Space Network - See Chapter 03

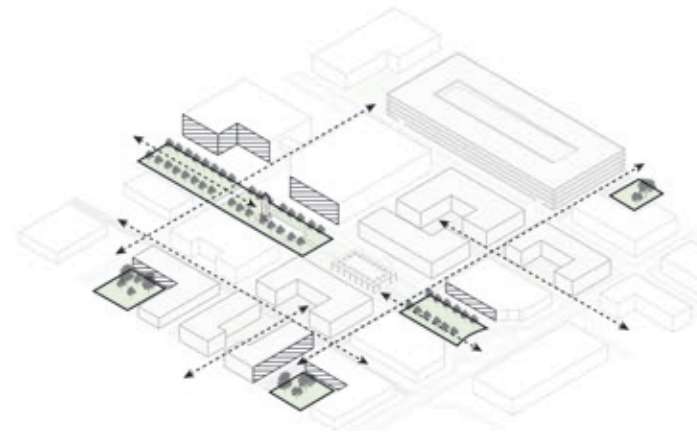

Reinforce Existing Open Space

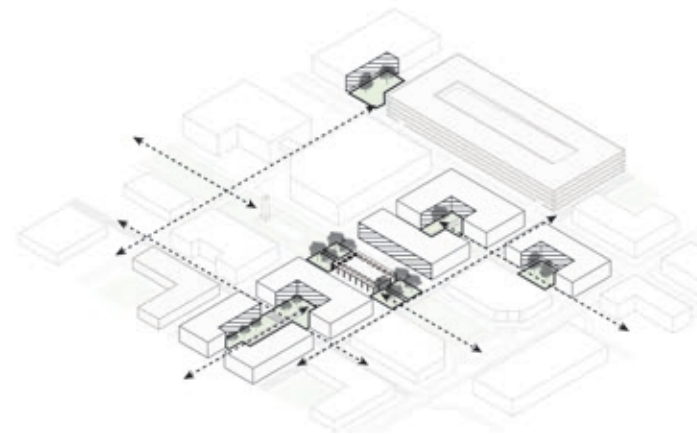

Create New Open Space

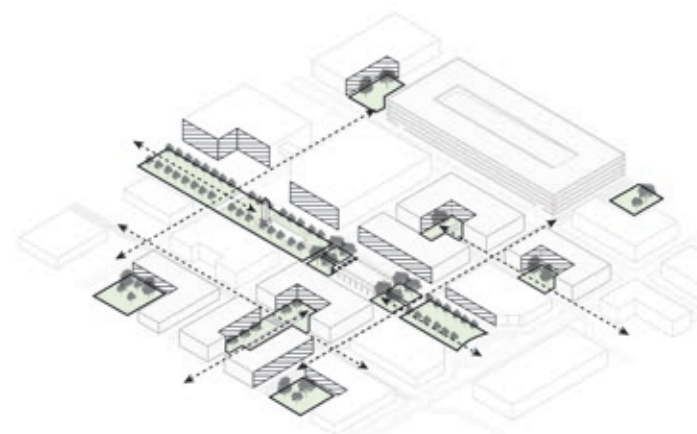

Enhanced Open Space Network



Northside Housing Open Space

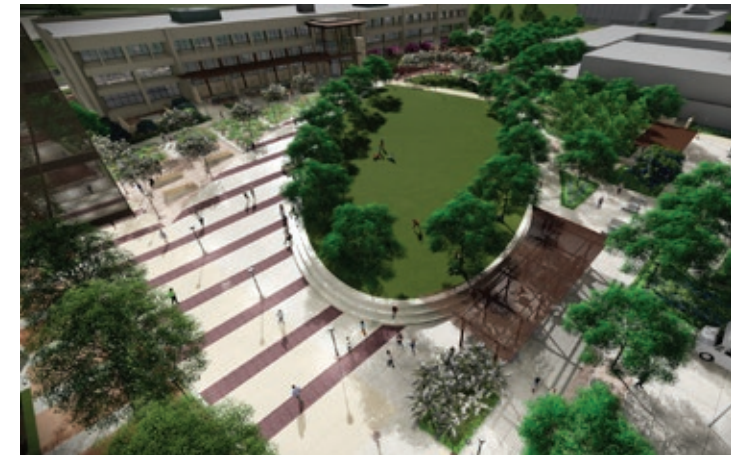

New E-Quad



Engineering Activities Building - Pocket Park

1.6 - PEDESTRIAN CONNECTIONS:

As a guiding principle, the Campus Master Plan seeks to focus mobility planning on the pedestrian in order to create a safe experience for campus users. In order to support the expansion of the Pedestrian-Priority Zone, which is a planning tool for future development to prioritize the pedestrian connections over the vehicular access, each building project must demonstrate new and improved connections on the site as well as extending or creating new connections linking into the Open Space Network. Pedestrian connections such as Malls, Connectors, Multi-Use Paths, and the Urban edge should align with the Landscape Guidelines located in this chapter.



Congestion at Existing Pedestrian Pathway - Evans Library



New buildings should enhance the pedestrian connectivity of the campus by creating or improving People Movers such as Malls, Connectors, and Multi-Use Paths.



Pedestrian-Priority Zone - See Chapter 04

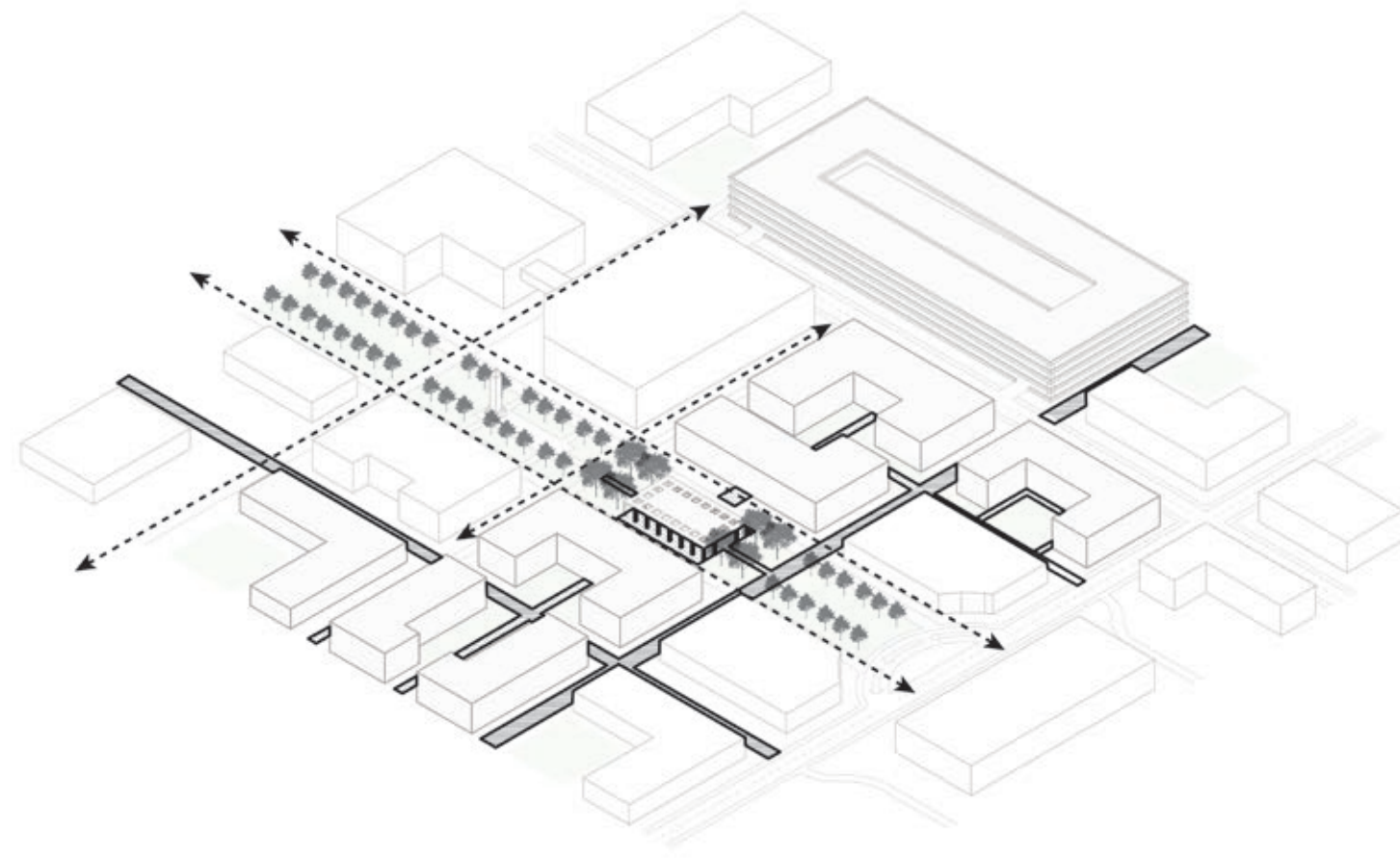

Reinforce existing or develops new pedestrian connections

1.7 - VIEW CORRIDORS (VISTAS):

View Corridors are defined by adjacent building facades and heights, tree lines or a sequence of outdoor spaces with a monumental building, public art or a sweeping view of campus as a focal point. Future development should maintain and strengthen existing View Corridors on campus. As the campus grows, new View Corridors along the Open Space Network and Framework Schema will be create that increase the visual connectivity and sense of place across campus.



Academic Building and Plaza



Military Walk



Bonfire Memorial

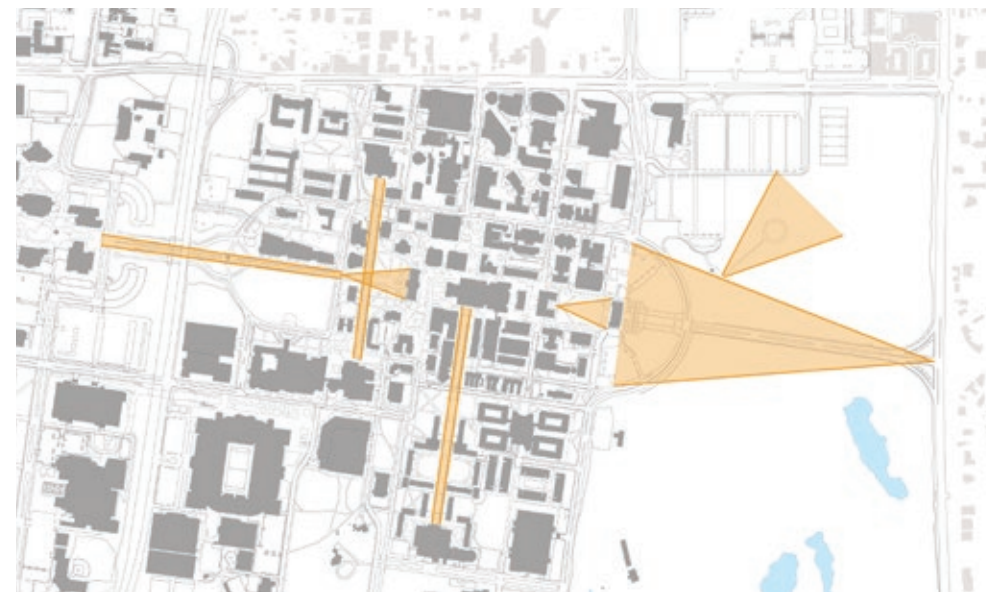

Existing View Corridors - See Chapter 07

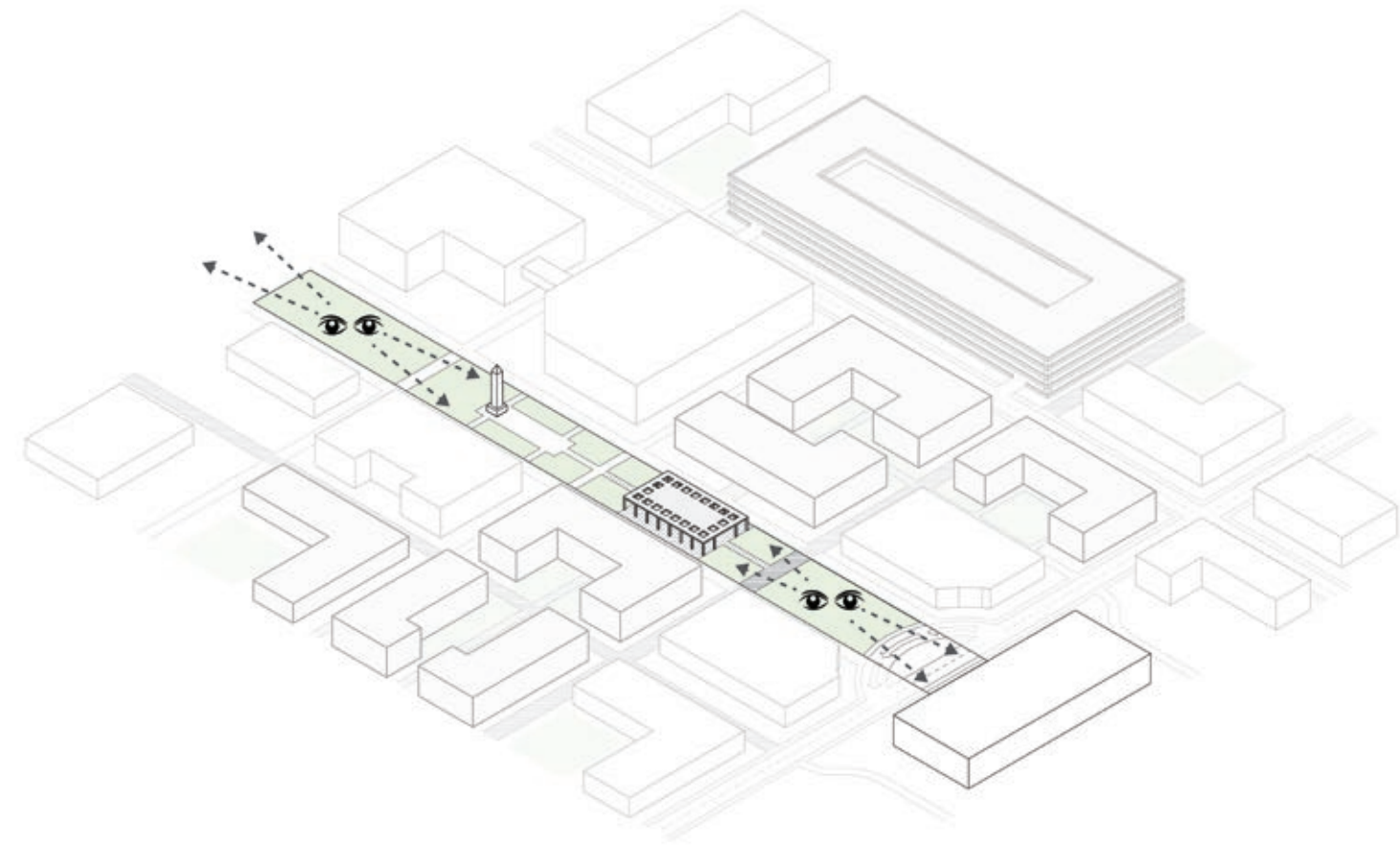

Create and Maintain View Corridors

1.8 - MOBILITY INTEGRATION:

The proposed project and user mobility needs are accommodated utilizing the hierarchy of priority identified in the Campus Master Plan – placing primary emphasis on the pedestrian-oriented intent of the campus experience. Secondary support to be provided through the creating or improving bicycle routes and bicycle parking. Project siting should allow campus users to walk to the proposed project within 1/4 mile from a parking structure (or existing surface lot) and/or transit stop. No new roadways should be created as part of a project, unless supported by the Campus Development Plan.

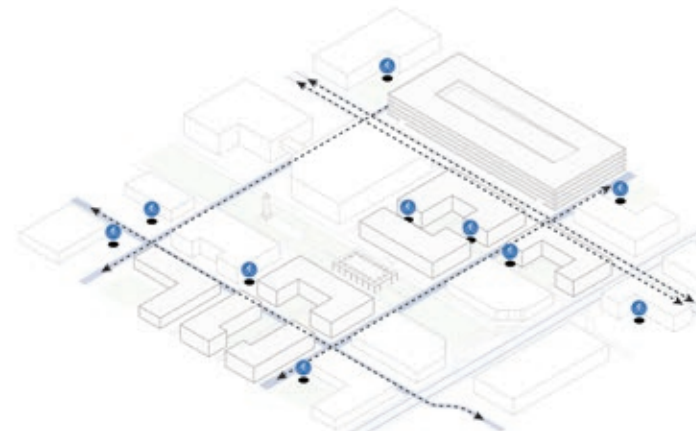

Bike Parking and Proximity

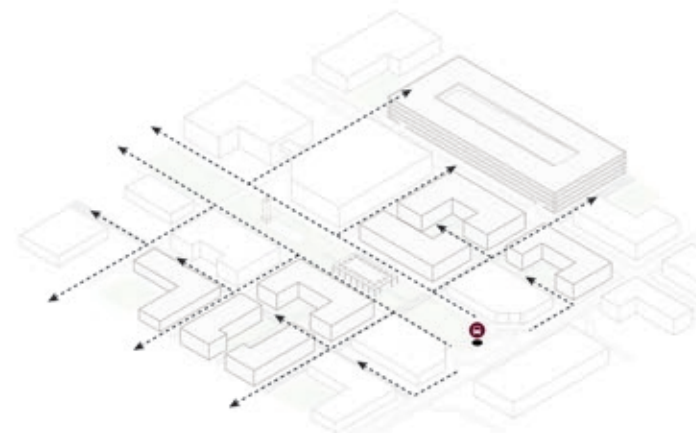

Transit Proximity

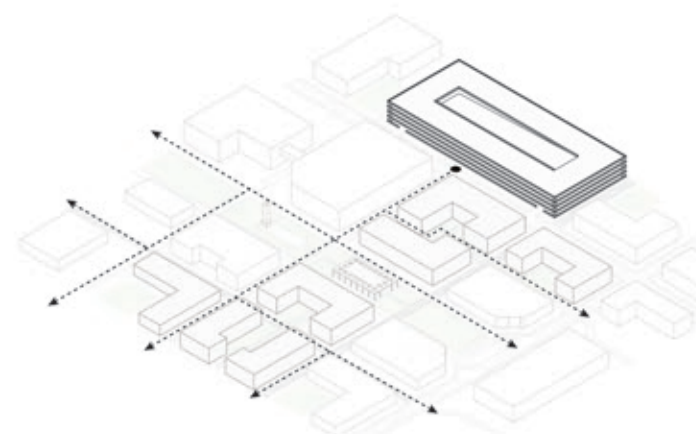

Parking Proximity



Proposed Screening at Bike Parking



Shaded Transit Stop



Bicycle Lanes and Safety Striping



Existing and Proposed Parking Structures - See Chapter 04

1.9 - INFRASTRUCTURE SUPPORT:

Infrastructure should be coordinated campus-wide and project-based utilizing the Open Space Network and Framework Schema to accommodate appropriate routing and avoid conflicts with future development. Long-term investments in infrastructure should be effectively planned so that the benefit of the investments are more fully realized. If a building project requires the redirection of or additions to the utility distribution network, the University can more cost-effectively spend its budget if a project locates that infrastructure to serve both the immediate project as well as future development.



West Campus Infrastructure Corridors



Research Park Development Plan Configured to Accommodate Existing and Future Infrastructure Corridors



Satellite Utility Plant Integrated Into Campus Architecture and Landscape

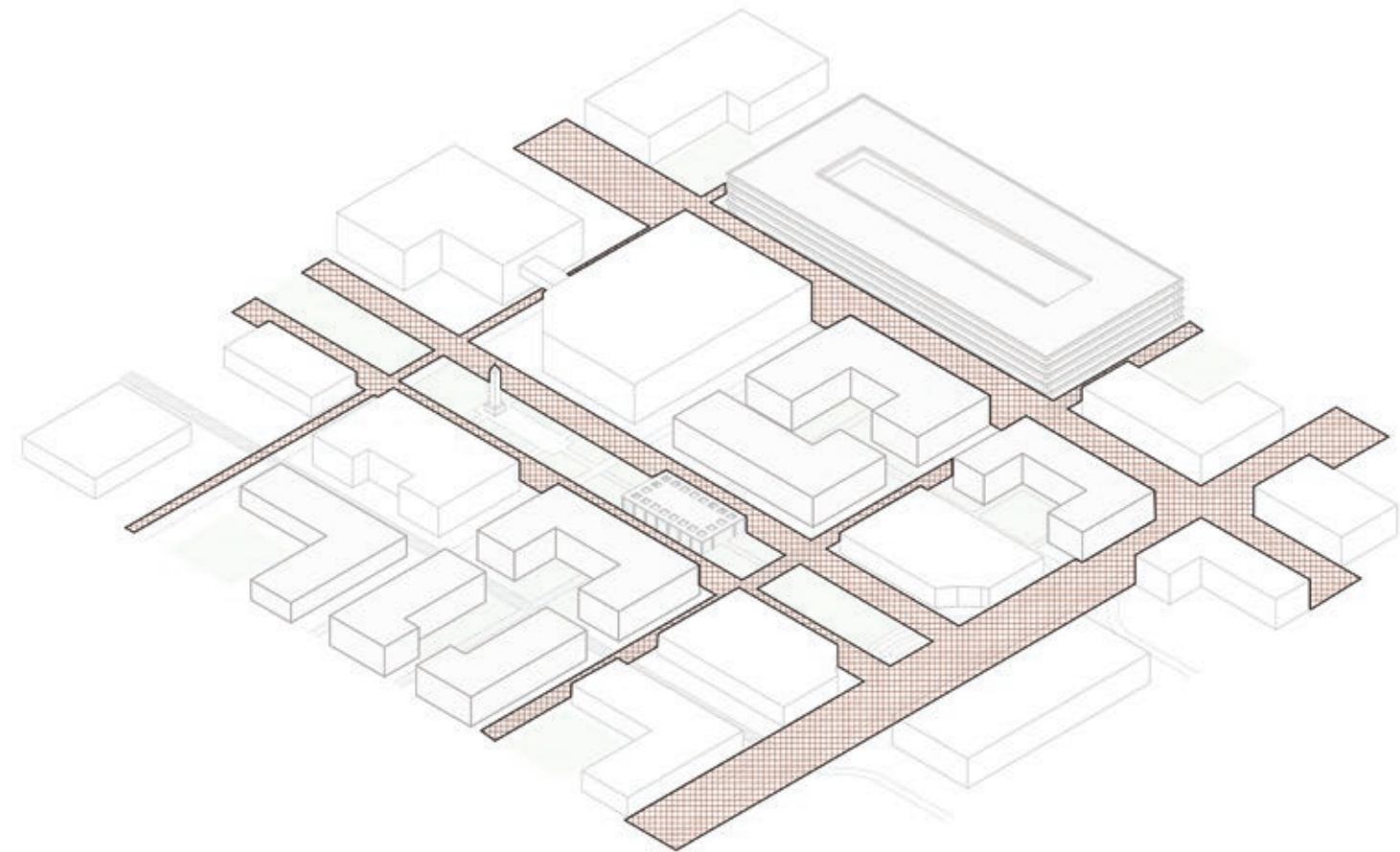

Align Utility Corridors with Framework and Open Space Network

1.10 - SERVICE CONSOLIDATION:

Service access accommodates the pedestrian-oriented intent of campus and is located to minimize impact on the campus experience. Service areas for adjacent buildings should be consolidated to the extent possible to minimize the distribution of vehicles within the pedestrian zone. Service requirements, such as loading and delivery, materials management and building service are supported without disruption to the existing campus configuration or circulation. Relocate unattractive and noisy ground-mounted infrastructure and equipment currently located along major pedestrian paths at the end of serviceable equipment life to less prominent locations.



Small Service Vehicle Parking



Service Pull Out Area



Dedicated Service Parking



Service Access Diagram - See Chapter 04

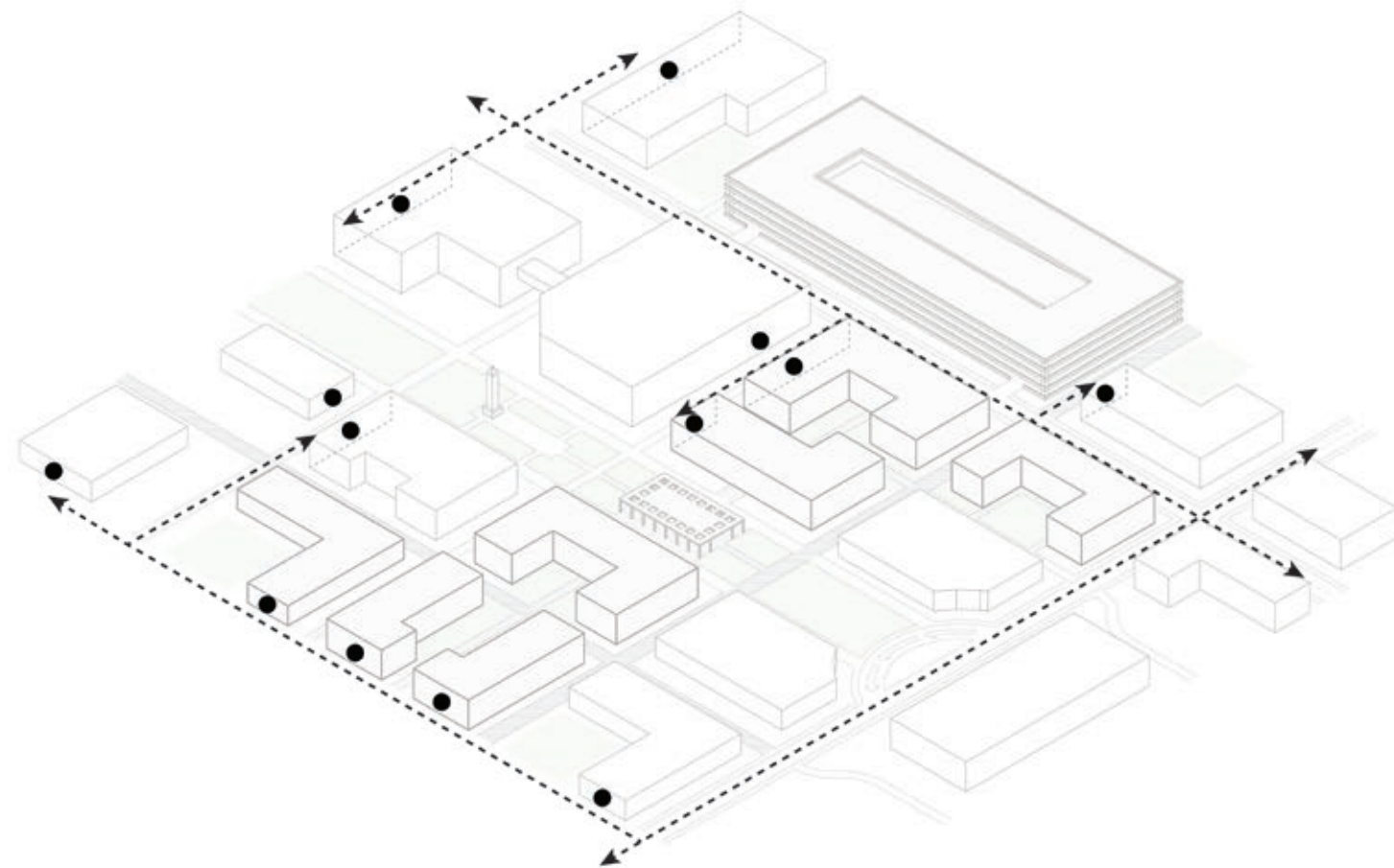

Service Access Diagram

Principle - 02
Site and Context
Development

These guidelines seek to emphasize the relationship between a project's program to its site and context. Integrating development into the fabric of campus requires sensitivity to existing conditions as well as consideration of future opportunities. Embedded in these guidelines is the intent of optimizing site development on campus to leverage institutional resources. This principle seeks to simultaneously deliver optimal site utilization for each building program while creating thoughtful open space and enhancing connectivity. Guidelines forming part of Principle - 02 include:

- 2.1 Increase Campus Density
- 2.2 Building Massing
- 2.3 Building Orientation
- 2.4 Alignments and Setbacks
- 2.5 Integrate Exterior Space
- 2.6 Entry Locations
- 2.7 Increase Connectivity
- 2.8 Mechanical & Service Areas

2.1 - INCREASE CAMPUS DENSITY:

Each Character Zone differs in proposed density profiles, with targets ranging between 0.50 and 1.0. Demonstrate optimized site yield through building placement, massing and height as well as alignment and relationship to the Open Space Network. Underdeveloped Character Zones of campus, such as West Campus and Research Park, require significant growth in order to achieve the proposed density profiles. If program allows, development priority should be given to these zones.

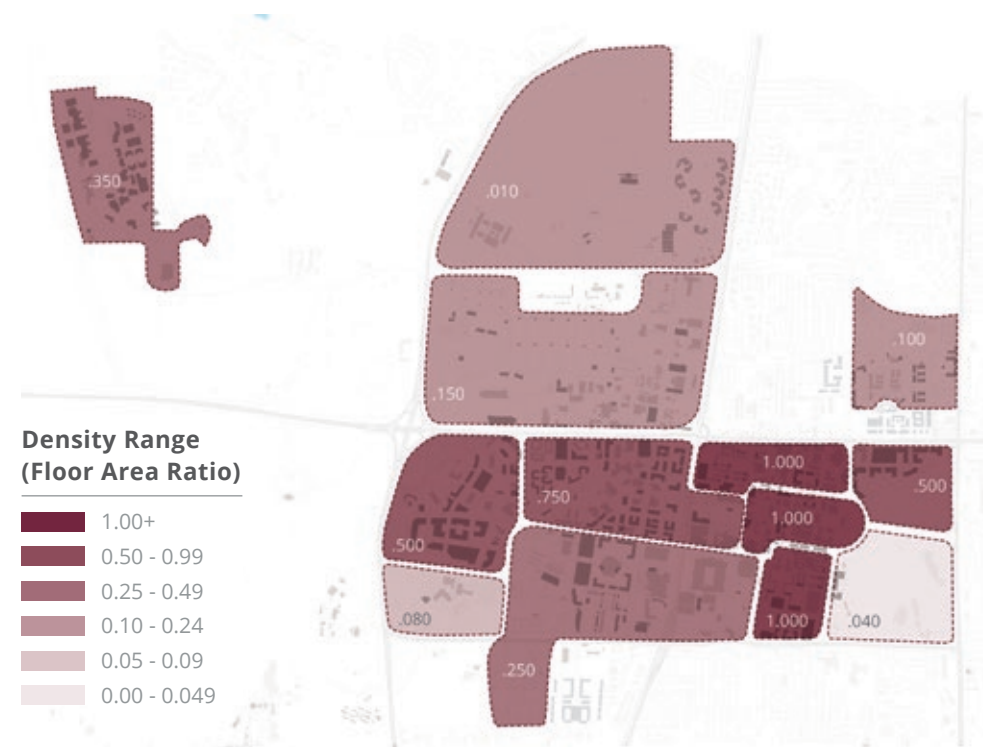

Proposed Campus Density (F.A.R.) by Character Zone

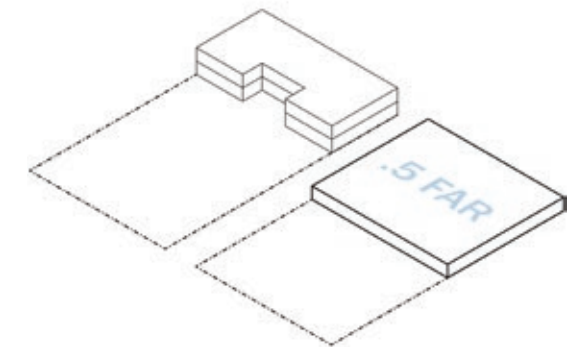

.50 Floor Area Ratio (Conceptual)

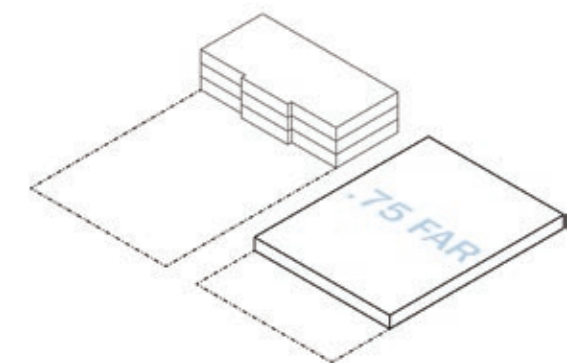

.75 Floor Area Ratio (Conceptual)

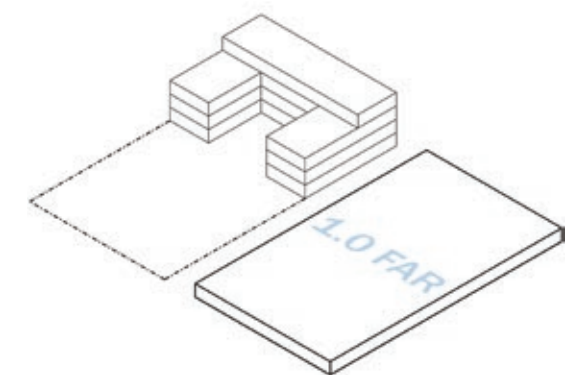

1.0 Floor Area Ratio (Conceptual)

2.2 - BUILDING MASSING:

The massing of the building will align the pedagogical or functional needs of the program/use while relating to both the campus context and immediate context by utilizing appropriate forms, heights and proportions. Building projects should support the ideals of the Framework Schema and Open Space Network to create an urban campus by: siting the building to engage and define streets, pedestrian paths and open spaces, aligning with nearby facades, and maintaining human scale at the ground level.

Existing campus buildings, such as the Academic Building, that respond to the campus civic structure/framework and successfully define outdoor spaces tend to be simpler in massing. Building plans should be simple in geometry, avoiding excessive width, mass or overly complex shapes. Building use and program should suggest the floor plate size and depth, but optimal dimensions should maximize daylighting and natural ventilation opportunities.



The Academic Building which is simple in its massing, responds to the campus civic structure/framework, successfully defines outdoor space and supports an important campus view corridor.



The Memorial Student Center illustrates a strong articulation of building massing relating to its specific site and context helping to define interior and exterior space.

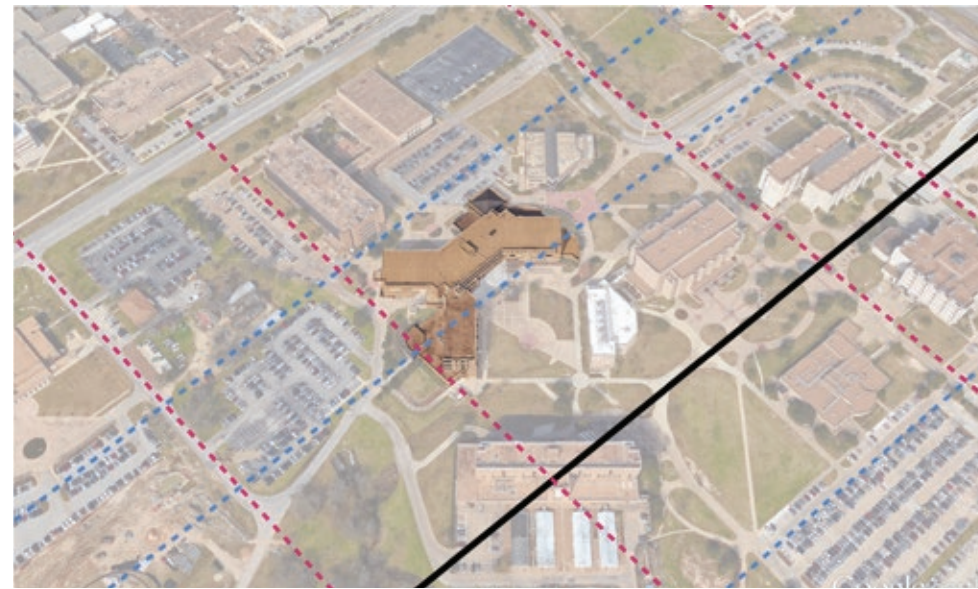

The Wehner Building is a large, amorphous shape and does not respond to the civic structure/framework of the campus. It also does not create nor respond to appropriately sized open space.

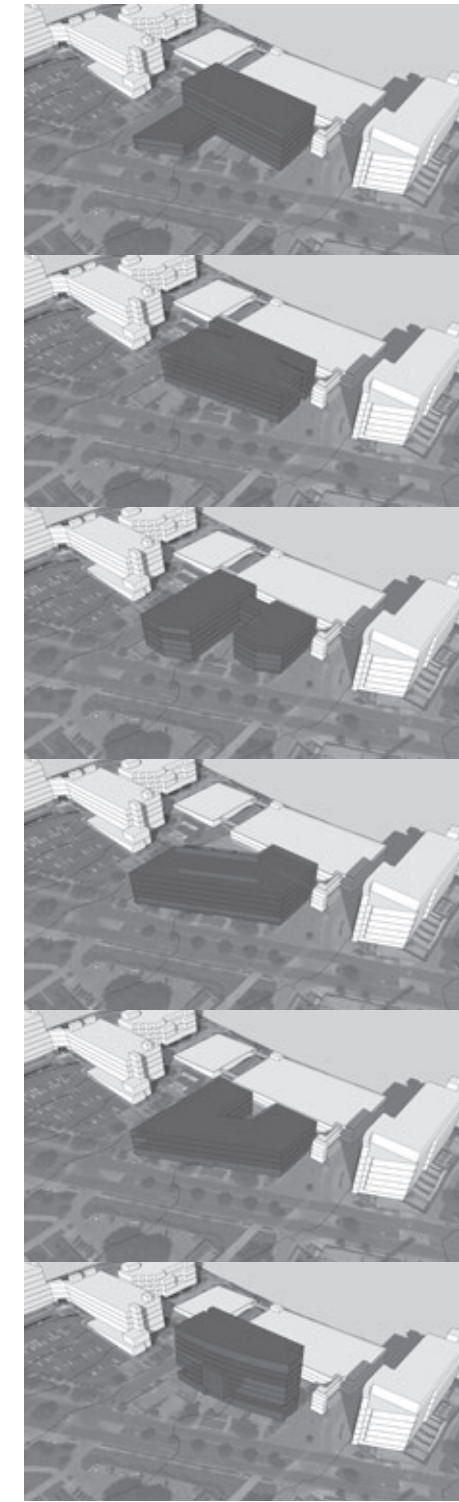

Example of Building Massing Study

2.3 - BUILDING ORIENTATION:

Develop siting to thoughtfully address and define the relationship between the Open Space Network and the building edge. The siting and massing of buildings should strengthen the definition of the adjacent open space, with particular emphasis given to the relationship to pedestrian pathways and experience. The primary orientation of buildings should be to the adjacent and dominant component of the Open Space Network or Framework Schema

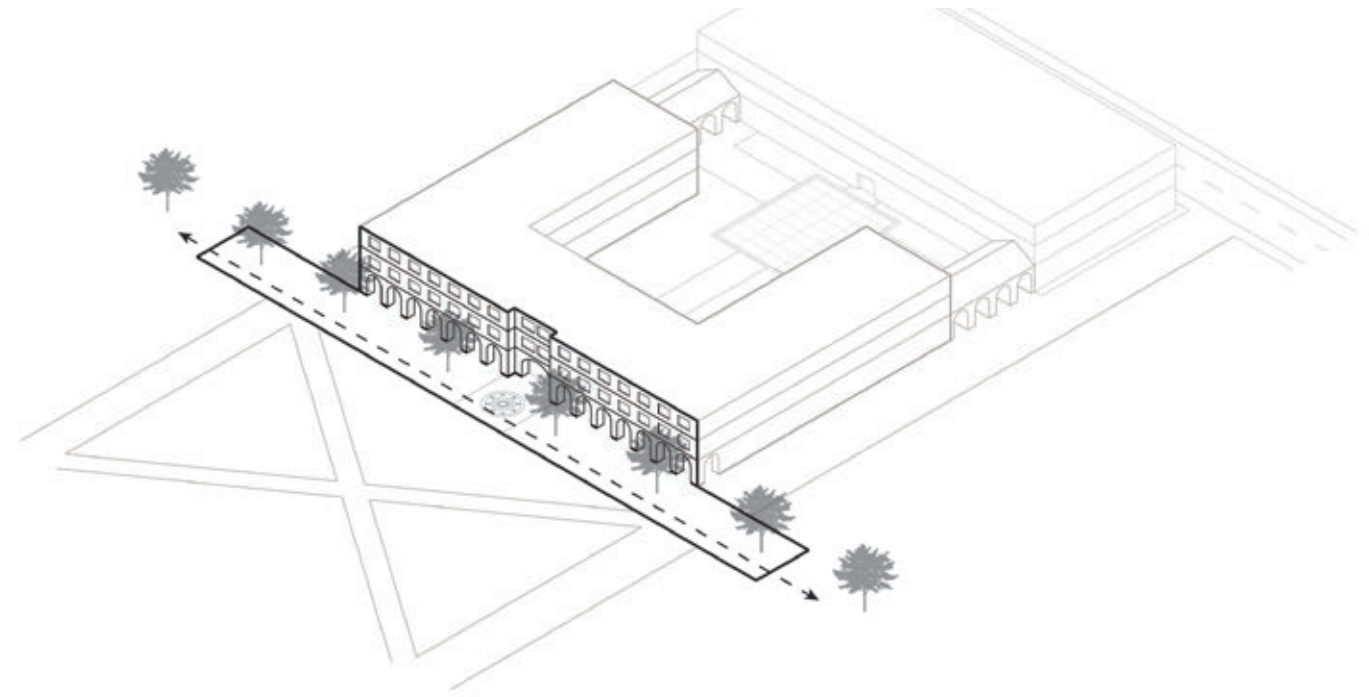

Building Orientation Aligned with Primary Path of Travel



Pathways and Quads Defined by Building Orientation

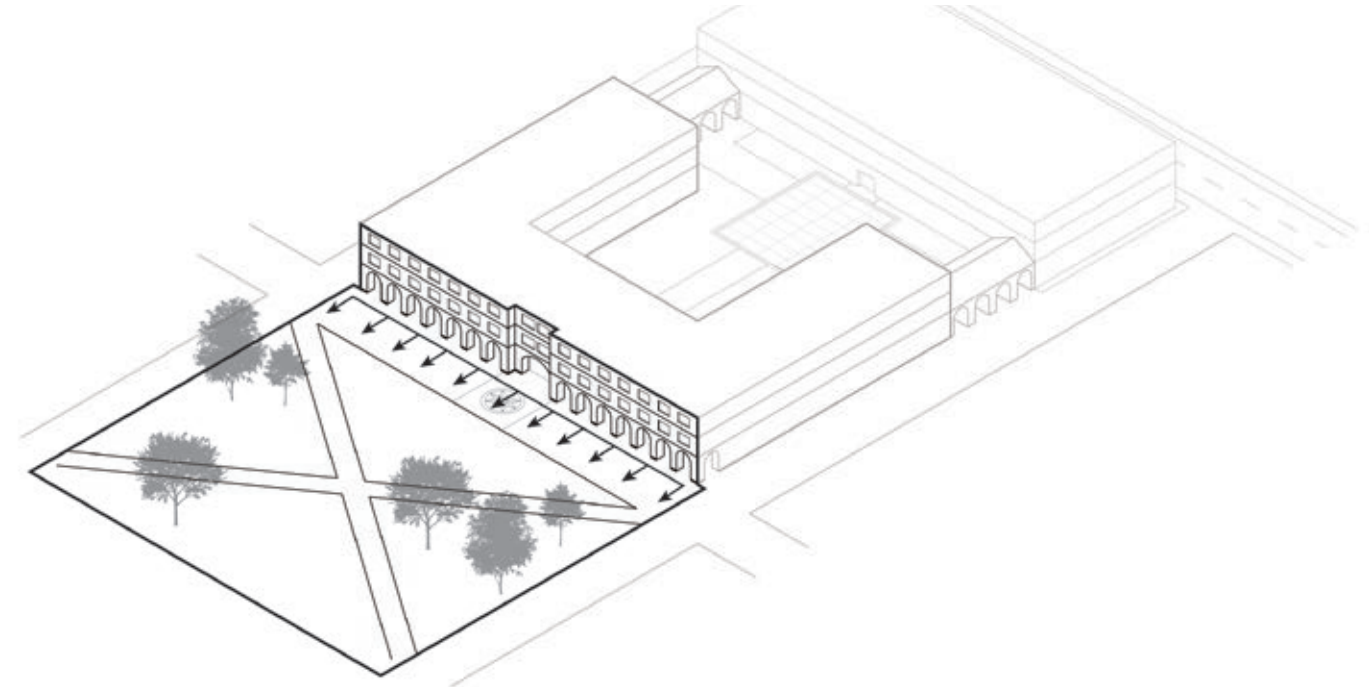

Building Orientation Defines Edge of Open Space

2.4 - ALIGNMENTS AND SETBACKS:

The Open Space Network, Framework Schema and immediate context will inform the appropriate setback and alignment of new construction and additions. While there is no official campus regulating plan, in every case possible, buildings should align with existing adjacent buildings, especially along existing campus streets, major pedestrian spaces such as plazas, malls, and pathways and important view corridors. Consistent setback lines along campus streets, and particularly campus edges will help define the street space and reinforce the campus edge.

Some variation in the building face (both encroachments and set-backs) to add focus to the entryway, places for informal gathering and enhanced landscaping are seen as assets. However, in no case should these variations or encroachments block view corridors or pedestrian pathways.



The consistent alignment of buildings along the north and south malls of Evans Library clearly define the pedestrian zone.



Alignment Define Pathway

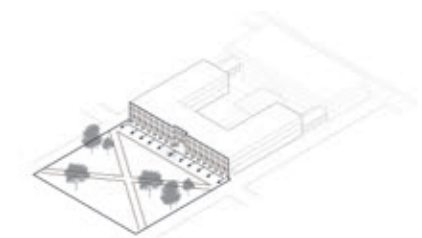

Alignment Defines Open Space



2.5 - Building Alignment and Setback: Ross Street is strongly defined by aligned facades and reinforced by tree lines. This street is a strong and important access for the campus.



Ross Street is strongly defined by aligned facades and reinforced by tree lines. This street is a strong and important access for the campus.

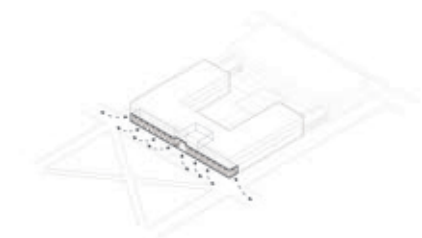

Colonnade Articulates and Activates the Edge Condition

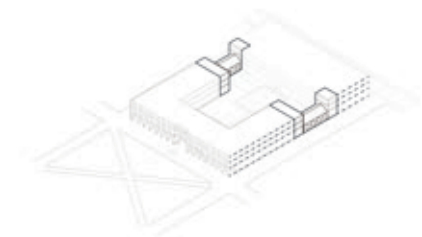

Alignment of Additions to Existing Buildings

2.5 - INTEGRATE EXTERIOR SPACE:

Create and integrate exterior spaces such as malls, quads, courtyards and/or pocket parks into the siting and plan format of the building. These spaces should be linked into the larger Open Space Network. Building oriented exterior open space should have a reciprocal relationship to the Open Space Network where each supports and enhances the other. Open space is intended to be a 'positive' room rather than a 'negative' void or simple leftover' space. Develop siting to thoughtfully address and define the relationship between the Open Space Network and the building edge. The siting and massing of buildings should strengthen the definition of the adjacent open space, with particular emphasis given to the relationship to pedestrian pathways and experience. The primary orientation of buildings should be to the adjacent and dominant component of the Open Space Network or Framework Schema.

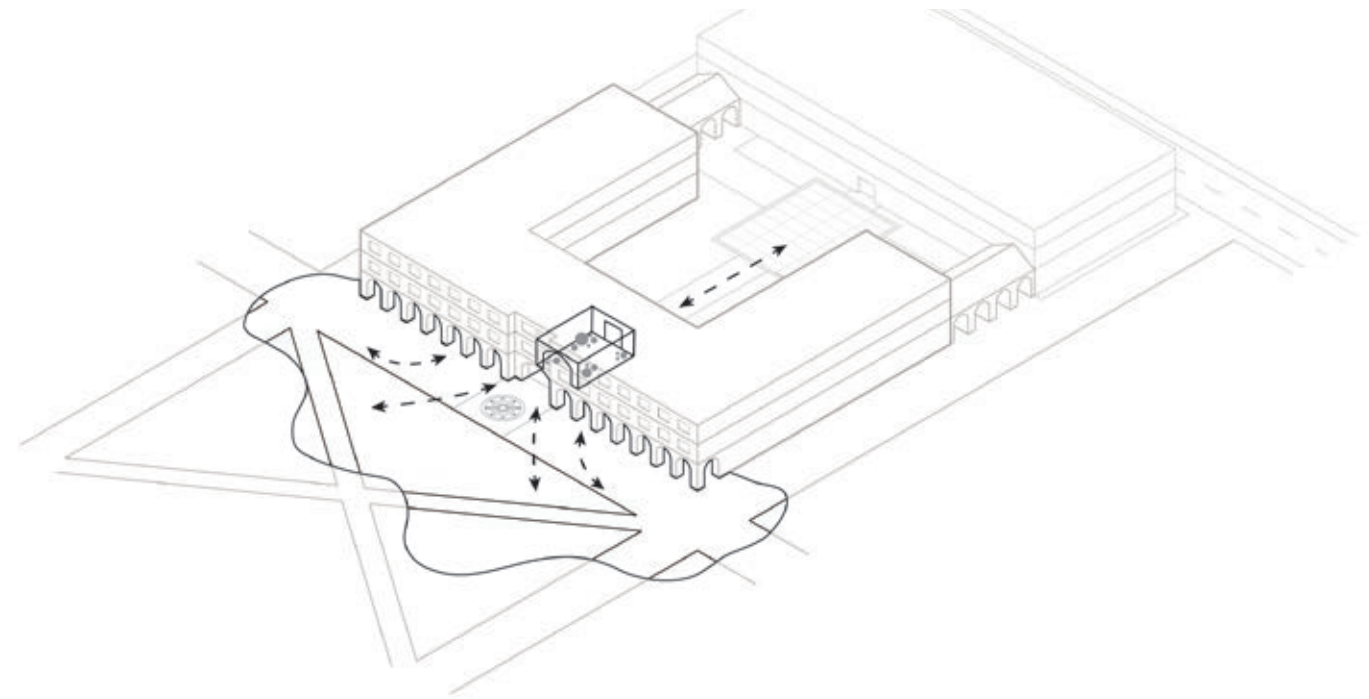

Activated Lobby Serves as an Extension of the Exterior Space



Hullabaloo Hall - Programmed Exterior Space Supported by Amble Site Amenities.

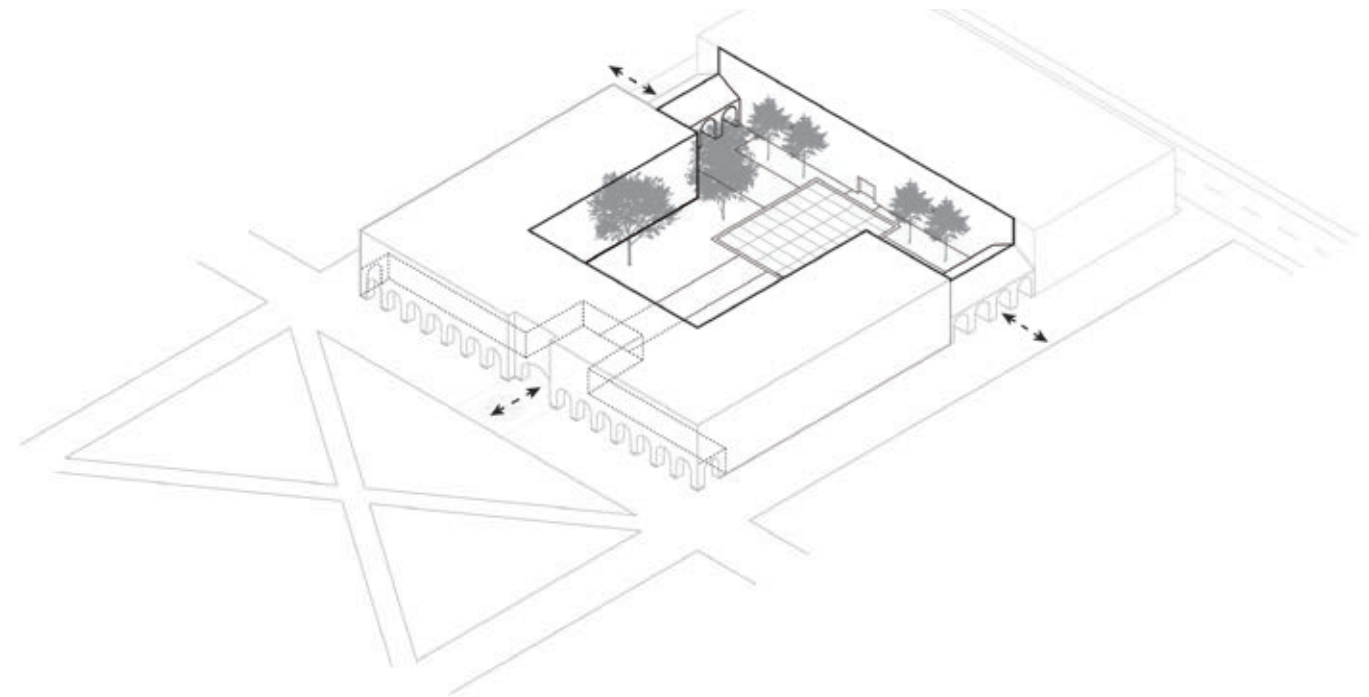

Courtyards and Pocket Parks Connect Exterior and Interior Space

2.6 - ENTRY LOCATIONS:

The primary building entry should be aligned to a major open space, street or pedestrian pathway to which the building is oriented. Building entrances should be connected to both exterior public spaces, such as a quad or courtyard, and interior public spaces, such as an atrium or lobby. By connecting the entry to public spaces, the entrance blends the outdoor and indoor space and becomes a place for campus users to interact and socialize.

The architectural treatment of the main entry should be grand and legible from a distance - this includes significant voids or glazing within the building envelope, large columns, projected overhangs, or other similar devices. Landscape treatment of the main entry should have a balance of hardscape and softscape areas, shade structures, canopy trees, shrubs, accent plantings, adequate site lighting, and seating to accommodate small gatherings, such as site walls, super stairs, benches, etc.

In every case that it is possible, the main entrance should also be the accessible entrance. Additional entries will align with secondary opens spaces and pathways as necessary.



Entry at Agricultural and Life Sciences Building



Entry at Chemistry (Note Non-Accessibility)



Proposed Entry Addition at Wisenbaker Engineering Building

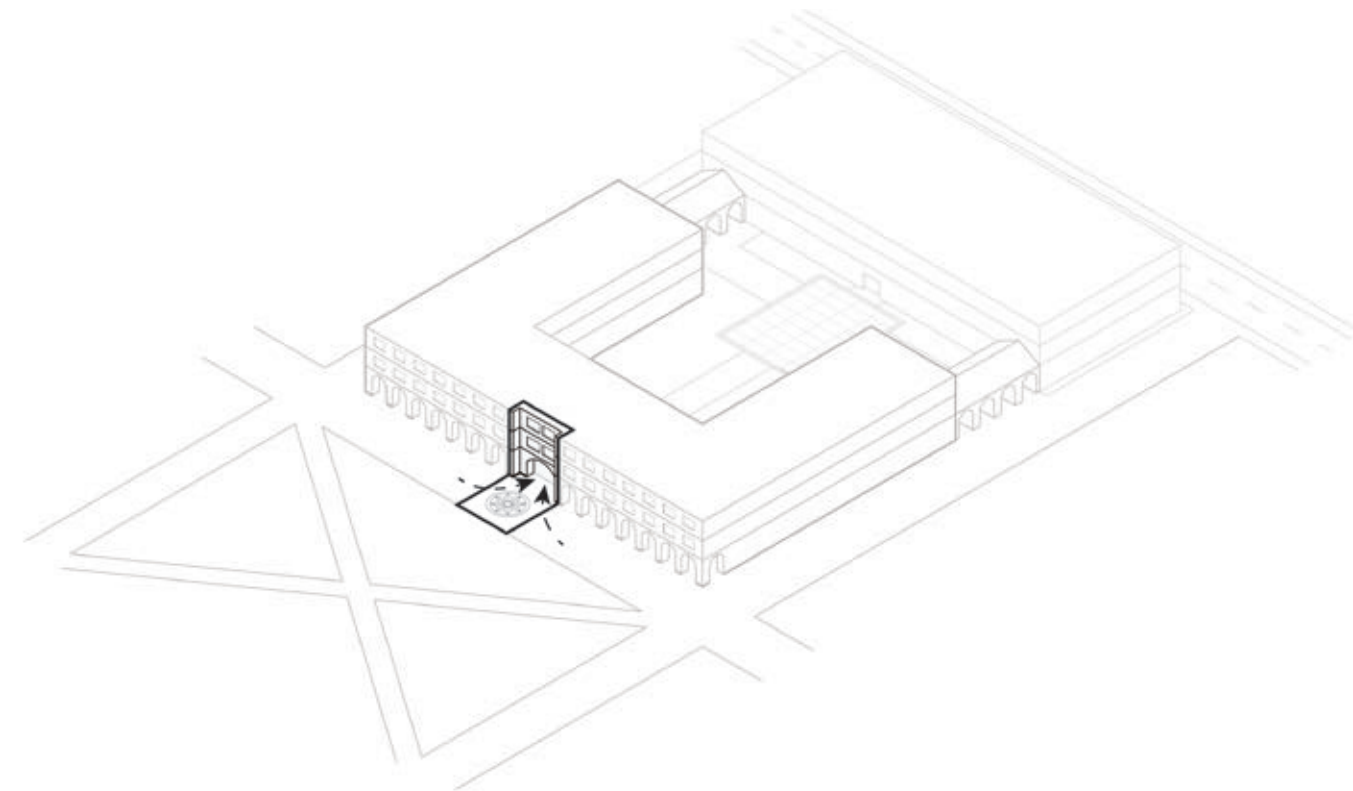

Main Entry from Primary Pathway and Open Space

2.7 - INCREASE CONNECTIVITY AND ACTIVITY:

Addressing the space between buildings is a major driver for the planning process, and many of the elements of the Campus Master Plan support this concept such as the Open Space Network and heavy emphasis on programming landscape areas on campus. The project boundary for new buildings and major renovations should be larger than the building boundary to incorporate landscape, open space and pedestrian connectivity into the overall scope of a building project.

To support adjacent open spaces, new buildings and additions should include features that extend the presence of the building into the site such as loggias, porticos, colonnades, arcades, and overhangs. These features can define entries, provide shaded connections, reinforce the horizontal building base and define indoor-outdoor space such as courtyards and plazas. These features should create visual and physical connectivity with neighboring buildings.



Rudder Plaza

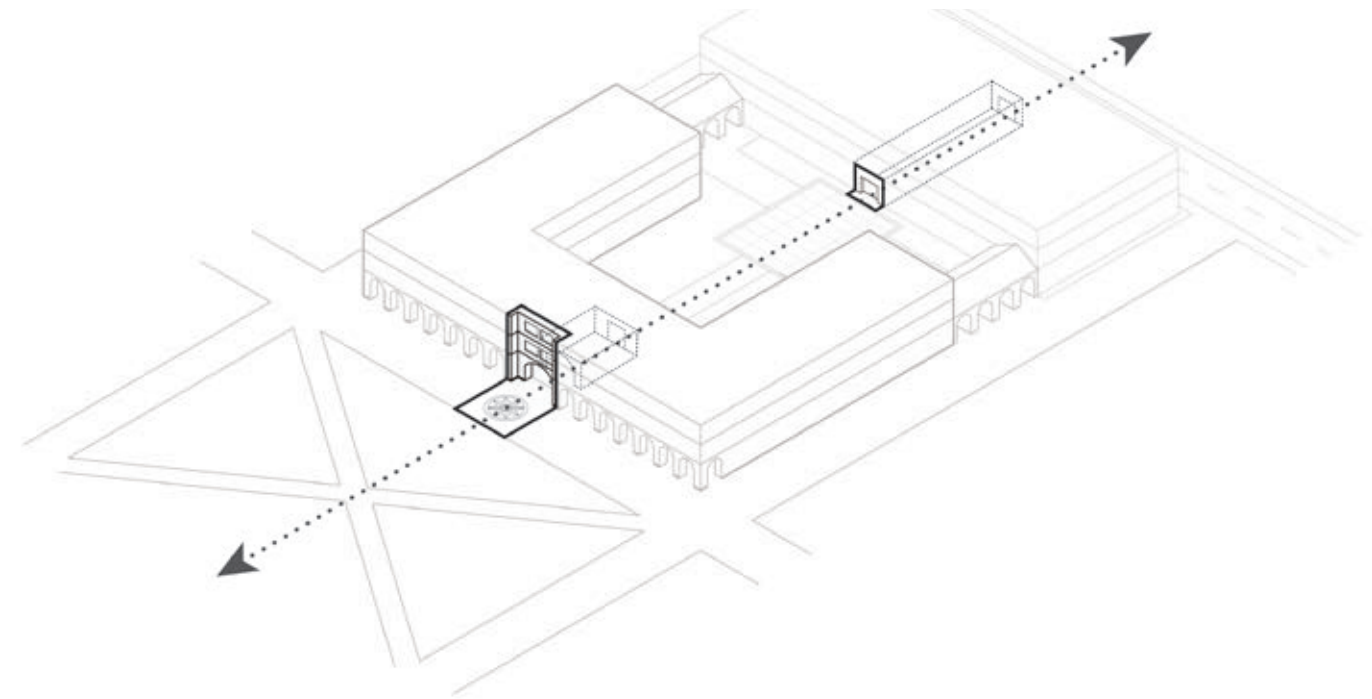

Aligned Entries Support Connectivity

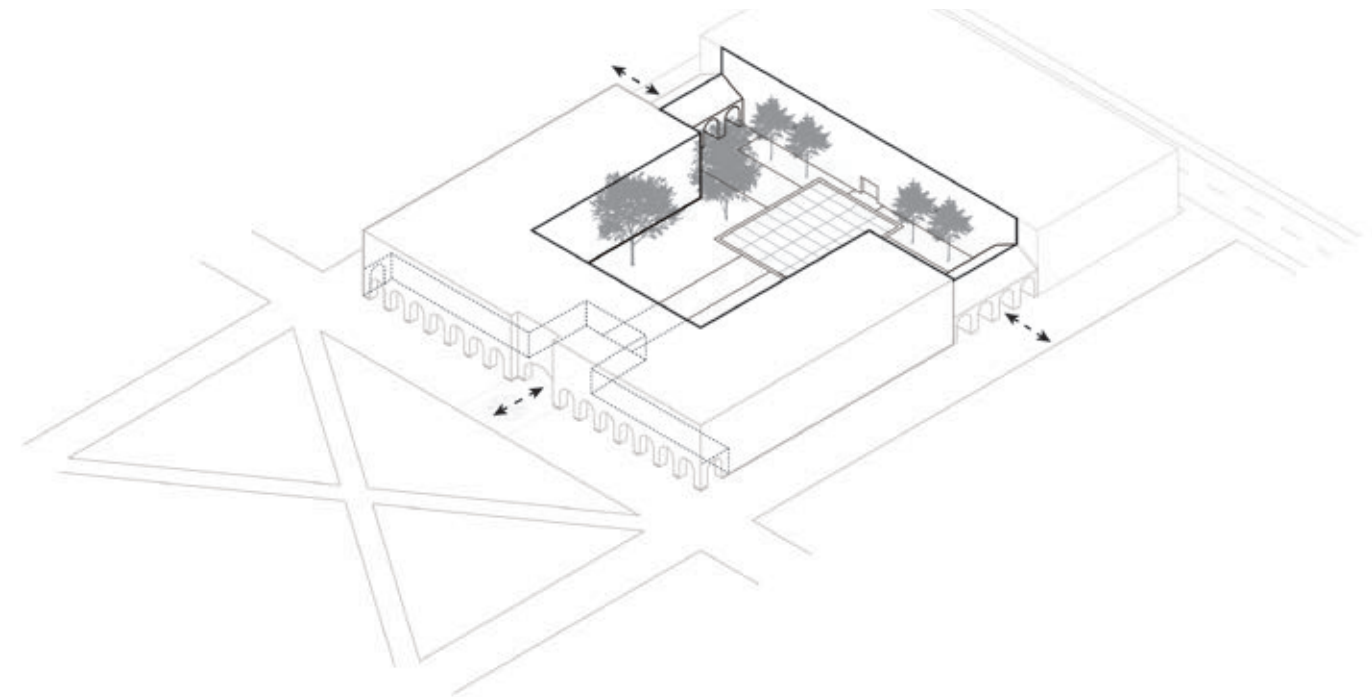

Courtyards and Pocket Parks Connect Exterior and Interior Space

2.8 - MECHANICAL AND SERVICE AREAS:

Service and mechanical screening should be integrated into the building design. If it is not possible to incorporate the screening into the building, service and mechanical spaces shall be screened with brick enclosures, softscape, or fencing, such as a louvered metal fence system. Brick or stone enclosures should be contextually appropriate to the adjacent building. Softscape screening can include landscape buffers, such as green walls or planted berms. Screening should keep service areas out of sight, while providing proper ventilation for the equipment.

Placement and design of service areas, waste dumpsters, recycling receptacles, and ground mounted equipment such as transformers, generators, cooling towers, condensing units, etc. must be coordinated and approved by the University Architect. Every effort shall be made to screen these elements with plant materials or/and fencing. Relocate unattractive and noisy ground-mounted infrastructure and equipment currently located along major pedestrian paths at the end of serviceable equipment life to less prominent locations.



Typical Pedestrian, Vehicular and Service Conflicts



Service Area Screened - But Exposed Rooftop Equipment



Equipment Screening at Liberal Arts and Arts & Humanities

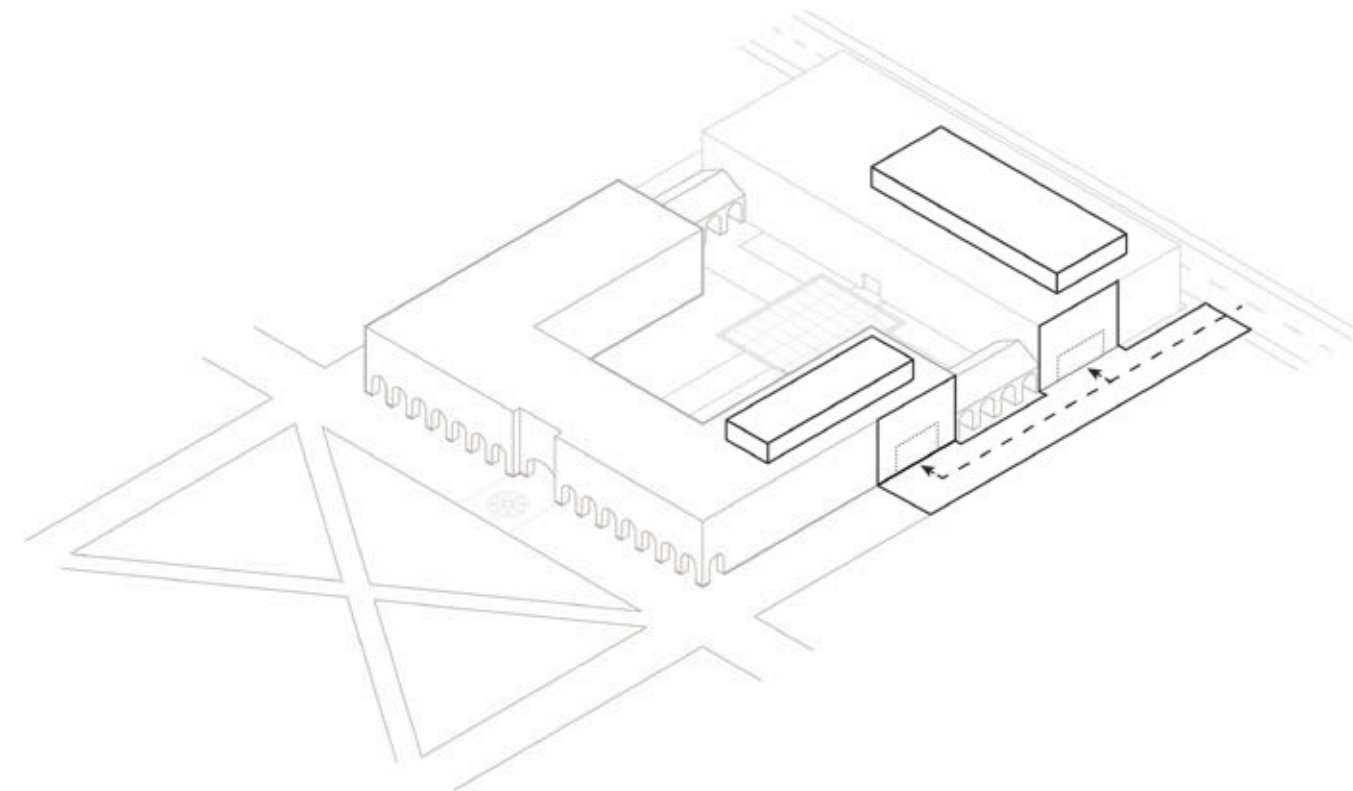

Locate and Screen Mechanical and Services Areas for Minimal Impact on the Built Environment

COMPILED SITE AND CONTEXT DEVELOPMENT DIAGRAM

The adjacent diagram combines the various site and context development guidelines into a single diagram illustrating their integrated nature. The various guidelines are interrelated and support one another in crafting a responsive design sensitively integrated into the campus fabric while considering future opportunities.

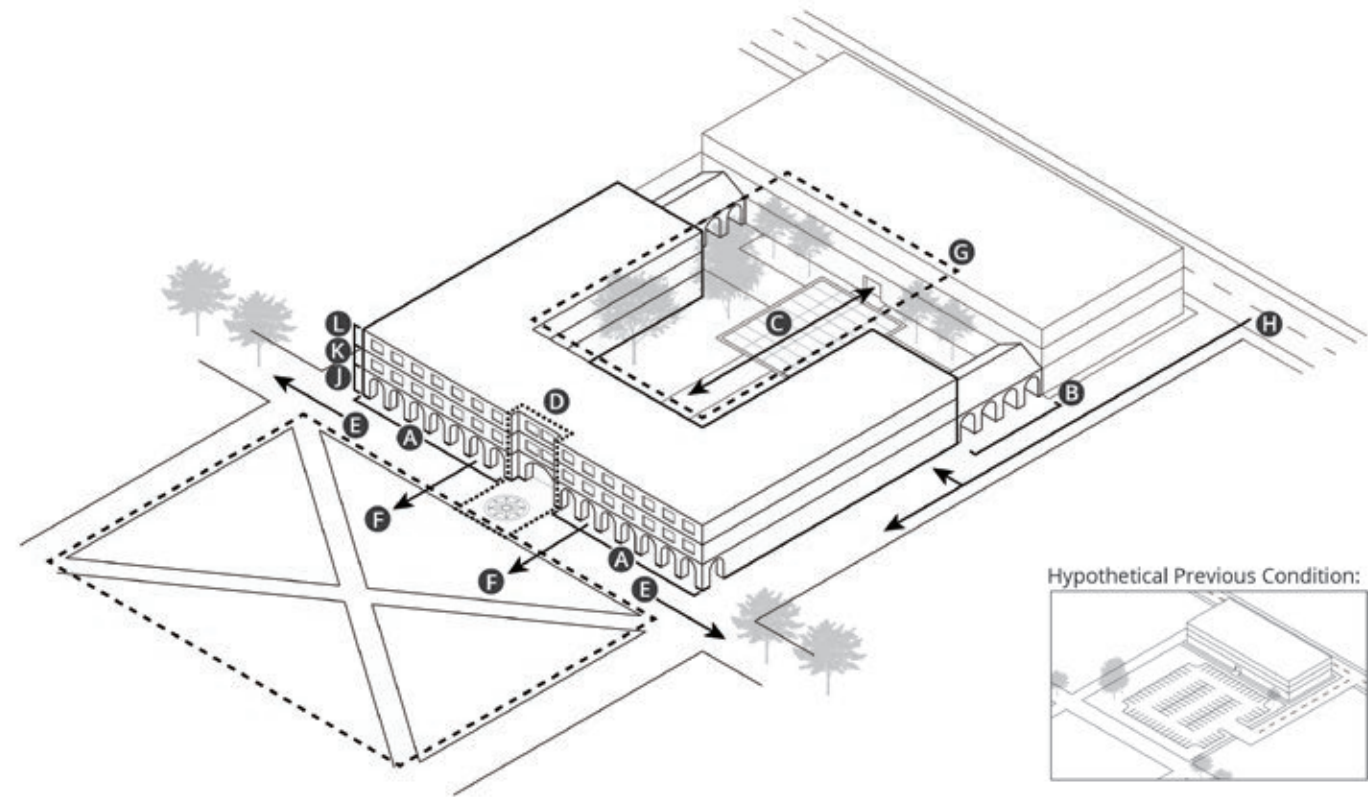

Colonnades and Outdoor Connections

- A** Extended colonnades, loggias, or porticos extend the building into the site
- B** Increase connectivity between buildings with loggias or plazas
- C** Create visual and physical connections with adjacent buildings through shared spaces and coordinated entry points

Building Entrances

- D** Building entrances should be clearly visible, emphasized, and symbolically recognizable
- E** New buildings should be oriented along major pedestrian routes
- F** Buildings should be oriented to the campus civic structure and open space network

Site and Access

- G** Provision of building oriented green space should be included in design
- H** Service/emergency access aligns with the existing infrastructure.
- I** Connectors are multifunctional paths that should be sized no less than 20' wide to allow vehicular access

Facades and Fenestration

- J** Articulated base expression zone
- K** Articulated mid-section expression zone
- L** Articulated top expression zone

Principle - 03

Architectural Guidelines

Utilizing consistent yet flexible building design parameters, such as facade rhythm and material use, these guidelines create unity and character across the campus that respects its heritage while accommodating evolving program. Guidelines forming part of Principle - 03 include:

- 3.1 Urban Campus Buildings
- 3.2 Program & System Expression
- 3.3 Identity & Variation
- 3.4 Entrances
- 3.5 Facades & Fenestration
- 3.6 Material Palettes
- 3.7 Building Heights
- 3.8 Rooftop Equipment
- 3.9 Accessibility

3.1 - CAMPUS BUILDINGS ARE TO BE URBAN:

Campus buildings to be urban expressions reflecting the pedestrian nature of campus and the civic import of the University. The architecture should animate and create vitality to the campus via:

VISIBLE INTERIORS – BUILDINGS SHOULD BE DESIGNED TO MAKE ACTIVITIES OF THE UNIVERSITY BOTH APPARENT AND ACCESSIBLE FROM THE OUTSIDE. THESE ACTIVITIES INCLUDE THOSE THAT REPRESENT THE INSTITUTIONAL ENTERPRISE AND CORE VALUES.

PROGRAM AND ACTIVITY LOCATION – HIGHLY UTILIZED SPACES WITHIN BUILDINGS SHOULD BE LOCATED AT GRADE LEVELS ALONG EXTERIOR EDGES TO ALLOW VISUAL CONNECTIONS TO THE ACTIVITY. SUCH SPACES MAY INCLUDE LOBBIES AND LOUNGES, DINING SPACES, EXHIBIT SPACES AND INFORMAL GATHERING AREAS.

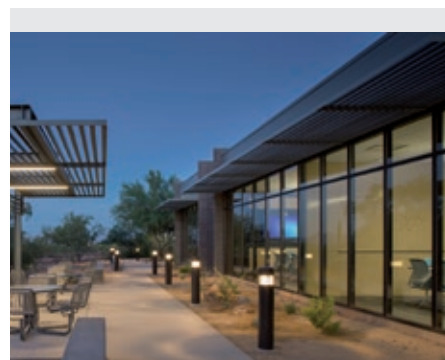

PERMEABLE GRADE LEVEL – TO SUPPORT VISIBLE INTERIORS AND VISUAL CONNECTION TO ACTIVITIES, GRADE LEVELS SHOULD BE VISUALLY AND PHYSICALLY PERMEABLE. AMBLE GLAZING SHOULD PROVIDE TRANSPARENCY AND LARGE EXPANSES OF SOLID WALLS SHOULD BE AVOIDED.

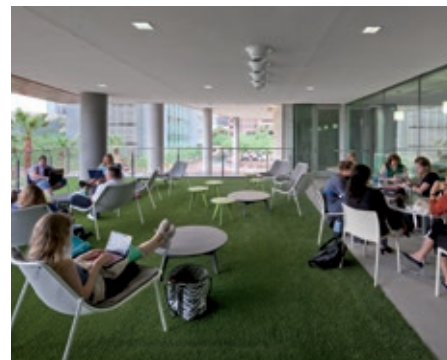

INTERIOR TREATMENTS – INTERIOR WALLS, ELEMENTS AND ARCHITECTURE VISIBLE TO THE EXTERIOR SHOULD BE DESIGNED TO ACCENTUATE ACTIVITIES AND REINFORCE LEGIBILITY OF ENTRY POINTS AND ADJACENT EXTERIOR SPACES.



3.2 - PROGRAM AND SYSTEMS EXPRESSION:

New construction and major renovations should endeavor to express the civic importance of the University by showcasing the activities of the institution thru:

PROGRAM REPRESENTATION – BUILDINGS SHOULD SEEK TO EMBODY IN ITS ARCHITECTURAL EXPRESSION, THE ACTIVITIES AND CULTURE OF THE PREDOMINANT PROGRAM TYPE LOCATED WITHIN SUCH AS INSTRUCTIONAL, RESEARCH, HOUSING OR OTHER TYPES.

LEARNING & DISCOVERY ON DISPLAY – WITHIN BUILDINGS, VISIBILITY INTO PROGRAM AREAS FROM PUBLIC SPACES CONTINUES THE THEME OF CONNECTING PEOPLE AND PLACE BY PUTTING ON DISPLAY THE ACTIVITIES OCCURRING IN INSTRUCTIONAL AND RESEARCH SPACES.

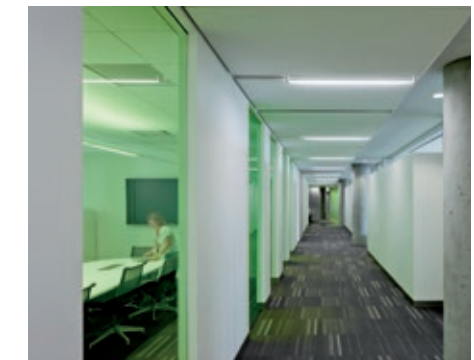

KNOWLEDGE SHARING – VISIBILITY OF ACTIVITIES CAN BE REINFORCED WITH INCORPORATION OF STATIC AND INTERACTIVE DISPLAYS INTEGRATED INTO THE DESIGN DESCRIBING THE ACTIVITIES OCCURRING WITHIN THE BUILDING TO RAISE THE AWARENESS OF THE CAMPUS CONSTITUENTS.



SUSTAINABILITY FEATURES — SUSTAINABILITY SYSTEMS AND FEATURES SUCH AS SOLAR SHADING AND STORMWATER MANAGEMENT ARE TO BE INTEGRAL PARTS OF THE ARCHITECTURE RATHER THAN 'ADD ON COMPONENTS'.



3.3 - IDENTITY AND VARIATION:

The campus has a history of building highly embellished and detailed structures, offering both a sense of identity and variety. This concept supports the realization of an urban campus with a rich pedestrian experience. Similarly, the opportunity exists for buildings and their respective Character Zones to conform to the overall campus character while reflecting a localized identity. The predominant physical parameters of individual Character Zones are the primary influence for projects located within a zone while simultaneously incorporating campus-wide parameters such as the use of stone within the material palette.

The design and expression of buildings plays an important role in establishing the identity of the University, reinforcing a distinct sense of place, showcasing the academic and research activities and creating vitality in the campus experience.

Designs should express this identity of the University by thoughtful incorporation of often conflicting requirements or permanence, heritage, innovation, sustainability, diverse programs, human-scale and so forth. Regardless of these myriad requirements, designs shall reinforce the unique sense of place that is Texas A&M University.



Southside



Historic Core



Historic Core



Northside



Northside



West Campus



West Campus



Athletic & Recreation



Research Park



University Dr. & Agronomy Rd.



F & B Road



Health Sciences Center

3.4 - BUILDING ENTRANCE(S):

Entrances are key aspects of a building's character and identity. They should be developed to recognize the civic scale of campus as well as support the interior and exterior transitions. They are to be clearly visible and recognizable, and should have a direct relationship to the public open space on which the building fronts. Primary lobby and circulation spaces inside the building should be designed as extensions of the campus spaces outside. Significant voids within building envelopes with projected overhangs or other similar devices may mark entry points.



Physical Education Activity Program Building



Selection of Heritage Building Entrances



Plank Leadership Learning Center



Agricultural & Life Sciences

3.5 - FACADES AND FENESTRATION:

Typically, the heritage buildings of the campus exhibit the qualities of well-ordered facades, with a clearly defined base, mid-section and top. They are often organized around a central entry feature. Windows are expressed as punched elements in a continuous masonry façade that are generally vertically proportioned and have expressed surrounds with a strong sill and lintel. Windows on the ground floor tend to be more elaborate in design, with many incorporating a unique stone ornament, and often an expression of a cornice tops the first floor. End bays of the façade are articulated by variation in the fenestration pattern, the plane of the façade, distinct decorative elements or other means.

Future buildings need not be simplistic copies of traditional buildings. Instead, they should draw from the lessons offered by successful campus buildings of the past, while responding to contemporary program requirements within the campus context. New buildings should respect the surrounding context and adjacent buildings in terms of mass, height, proportion and materials, and the spaces they create.

The design of individual building facades should respond to the hierarchical importance of the Open Space Network and Framework Schema onto which they face, while also providing for continuity amongst facades for the building to read as a single composition.

Whether projects are new construction, renovation, addition or a combination, they should engage with existing neighboring buildings and relevant Character Zone precedents so that the composition of groups of buildings share an identifiable relationship.

The role of scale and proportion in defining architectural character is a very significant one. Not only do they relate a building's parts to its whole, and dictate how buildings relate to the human body, they also govern the

relationship between groups of buildings and the outdoor "rooms" they create. In other words, scale and proportion influence not only the character of architecture, but the places that they define as well.

Building facades are to be thoughtfully composed and provide design character that supports both the campus-scale as well as the pedestrian-scale. Overall elevation compositions are to be articulated into elements providing rhythm, emphasis, and visual diversity.

Projects should continue an equivalent expression of the prevailing campus façade attributes including; a tripartite composition of base, middle and top; the vertical fenestration harmony; differentiated end bays; and clearly identified primary entry. The inclusion of these attributes in the design of current and future projects will contribute to a harmonious integration of new projects into the existing context.

While significant glazing is desirable at grade level to visually connect the people and activities within and without the building to one another, expansive extents of curtainwall are generally discouraged. Potential applications of larger portions of curtainwall might support differentiation at end bays or to articulate a clear point of entry. In limited cases, a project housing a signature program may be allowed a greater use of curtainwall to portray that program to the campus and community through increased transparency. End user and design teams are cautioned not to assume this exception will be granted without prior consultation with the Council for the Built Environment and the Office of the University Architect.

Further articulation of the façade is achieved by the compositionally appropriate application of details such as window sizing and placement, window surrounds, lintels, sills and other trim detailing the reinforces the human-scale and rhythm of the façade treatment.

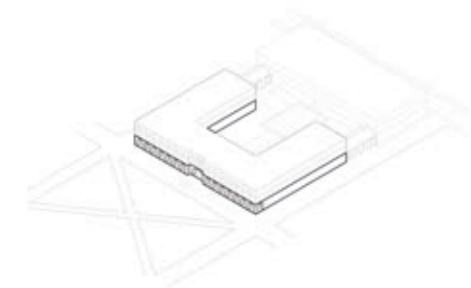
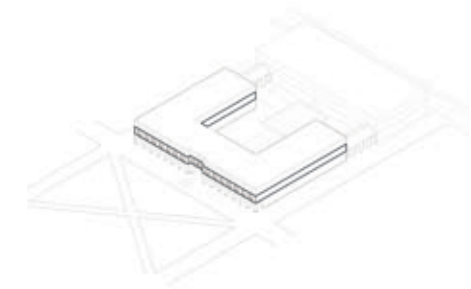
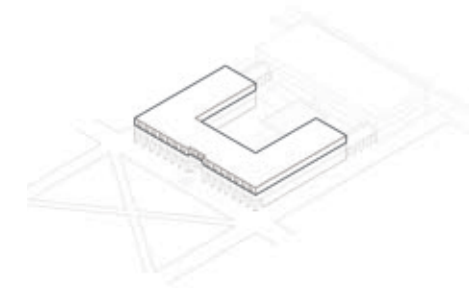

Tripartite Composition of Base, Middle and Top

A DIFFERENTIATED END BAY **B** VERTICAL FENESTRATION RHYTHM **C** ARTICULATE PRIMARY ENTRY

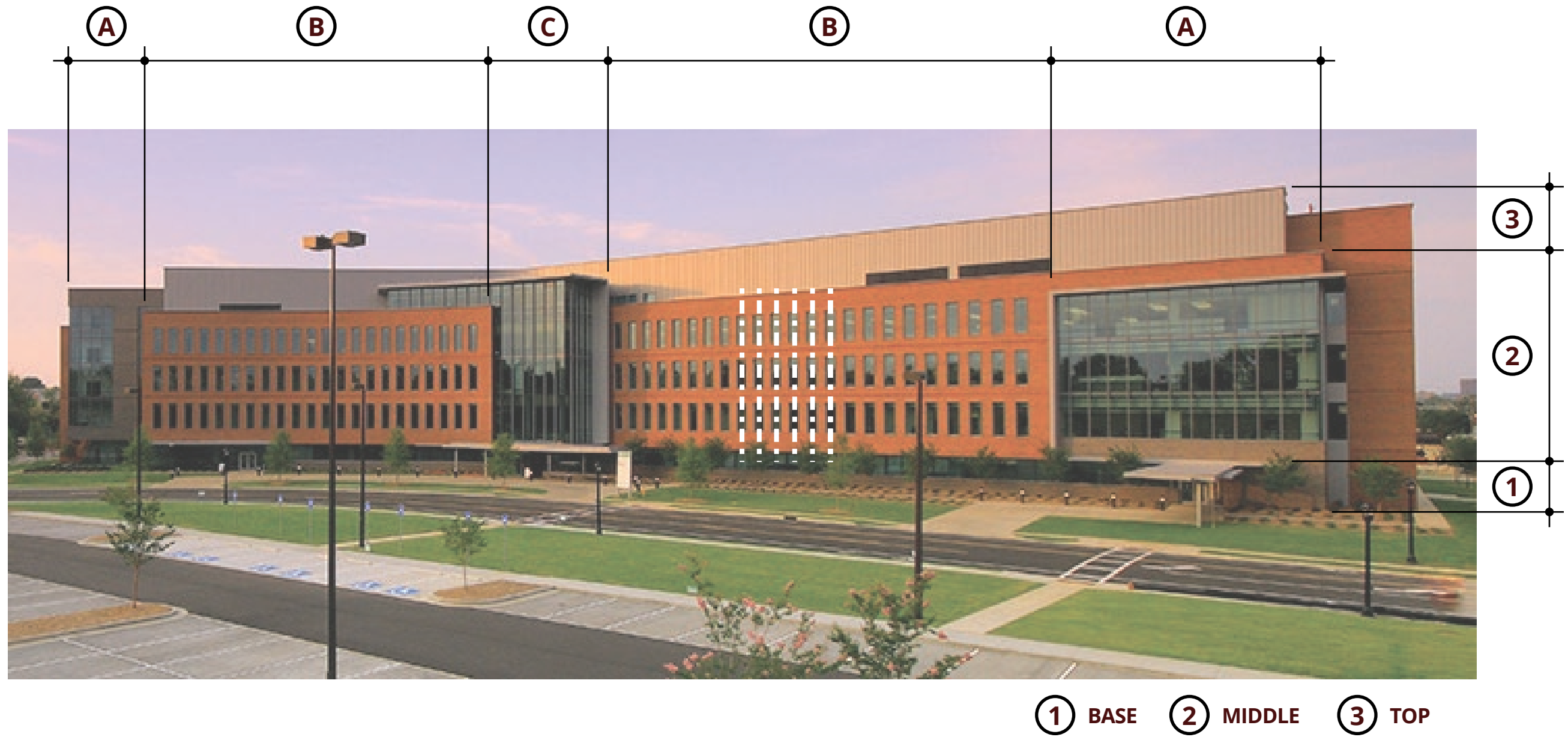

Sample Illustration Applying Attribute of the Facade and Fenestration Guidelines

3.6 - BUILDING MATERIALS:

Reinforcing the campus character through materiality is a key strategy to ensuring cohesive campus development. The historic use of masonry, as a primary building material, is fundamental to campus identity.

Selection of building materials will relate to and enrich the context within the Character Zone in which the building is located. Required common material(s) will serve as unifying elements across the campus and support the long-term reinforcement of the Texas A&M University aesthetic. A primary materials palette will align with the relevant Character Zone as will a secondary materials palette utilized in limited extents.

As the Campus Master Plan does not prescribe specific material mandates but, rather, establishes design directions, further details on materials can be found in the Texas A&M University Facility Design Standards. Principle #4: Character Zones Parameters also outlines relevant material usage based on location of projects.

Required Common Material – Limestone Masonry (Cordova Cream, Leuders or similar), in a limited variety of finishes, is the prime material to be utilized in projects to tie building aesthetic together across campus.

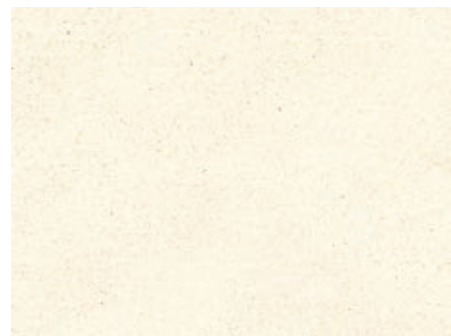

Cordova Cream

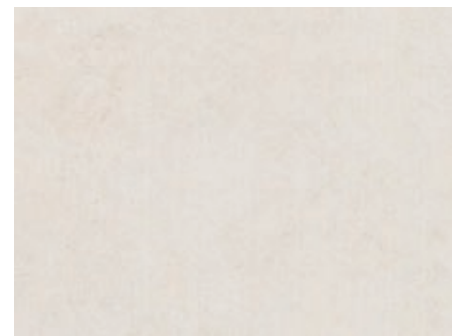

Leuders



Limestone Cladding and Window Surround at the Physical Education Activity Program Building



Limestone Cladding and Finish Variety at Agriculture & Life Sciences



Limestone Masonry on Liberal Arts and Arts and Humanities Bldg.



Limestone Masonry on Williams Administration Building

Primary Material Palette – the primary palette covers cladding, glazing and roofing materials.

Cladding: Predominately consisting of masonry inclusive of Brick (neutral, gray tones, tan, or buff in color) and Natural Stone (neutral or buff in color). Colors and finishes should appropriate to the relevant Character Zone.

Glazing: Types are limited in color and reflectivity. As noted in these guidelines, lower level areas are preferred to have greater transparency to provide visually connectivity between inside and outside spaces and activities. Mullions and frames shall be of a complementary color and tone to the overall building palette and not of high contrast.

Roofing: Exposed or visible roofs should consist of standing seam metal in material, color and finish appropriate to the relevant Character Zone.



Brick (Primary)

Secondary Material Palette – the secondary palette is intended for limited use for specific building systems application or as accent elements of Character Zones.

Metal – use in a limited capacity in panel form for cladding with color and finish to be approved. Additional use of metal for trims, closures, parapet caps and exposed miscellaneous metal

Ceramic Tile – relevant to a few limited Character Zones, ceramic tile can be found as an accent cladding material on some heritage buildings.



Biochemistry / Biophysics Building - Primary Brick Utilization

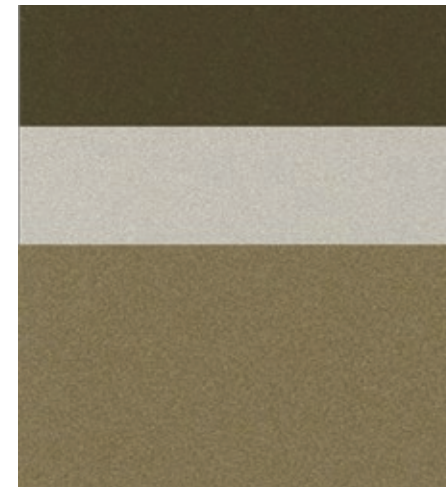

Metal Cladding: From Top to Bottom: Dark Bronze, Champagne, Bronze



H.J. (Bill) and Reta Haynes Engineering Building - Ceramic Tile Examples



Brick (Limited) From Left to Right: Athletics, Corps of Cadets, Northside Housing

3.7 - BUILDING HEIGHTS:

Directed by a desire to better utilize its land assets, increasing the density of the campus is a direction indicated in the 2017 Campus Master Plan. Building heights is one factor closely linked with the ability to increase density across the campus. At the same time, the campus seeks to maintain its identity and enhance the experience of constituents. While not in direct conflict, careful integration of the two is required to achieve a successful balance.

As with many parts of the master plan, building heights are greatly influence by the area context and Character Zone in which a project resides. Taller buildings may be appropriate in some zones to support additional campus density such as Research Park and in zones with existing taller buildings such as West Campus.

Determination of building height limits use three methods to establish the appropriate height with the most restrictive generally applying. Further limits or easing of them are at the discretion of the Council on the Built Environment and the Office of the University Architect. The following methods, from least to most restrictive generally, establish the appropriate building heights for the campus:

Allowable Number of Floors – This method identifies an appropriate number of floors for buildings across Character Zones. As individual floor heights are often dependent on specific program needs, this method can lead to unexpected results with buildings being taller than expect. For this reason, this method should only serve as general guidance when evaluate a sites potential capacity. The proposed range of allowable floors across campus span from one to seven floors, though one and two story buildings are discouraged except in a limited number of instances.

Maximum Measured Height – This method uses an assumed average floor height of 15'-0" multiplied by the greatest Allowable Number of Floors to determine a maximum height as measure to the highest parapet line or roofline peak. While the number of floors can be reduced to meet specific

program needs, such as a higher floor-to-floor height at the ground level, the Maximum Measure Height does not alter.

Height Above Datum – This method establishes a single datum height of 340'-0" above sea level across the entirety of the campus. This datum approximately equates to the topographical level of the Jack K. Williams Administration Building. From this level, a maximum height above the datum is established per Character Zone. As the topography changes across campus and within Character Zones, this method may be more lenient or restrictive based on a specific sites relationship to the datum. If the site sits below the datum, a greater height is potentially allowable, while the opposite is true if the site sits above the datum.

In each method, the limits pertain to total number of floors or measure height which is inclusive of non-occupiable space such as mechanical penthouse. Refer to Principle 04 – Character Zone Parameters for information regarding building heights relevant to each zone.

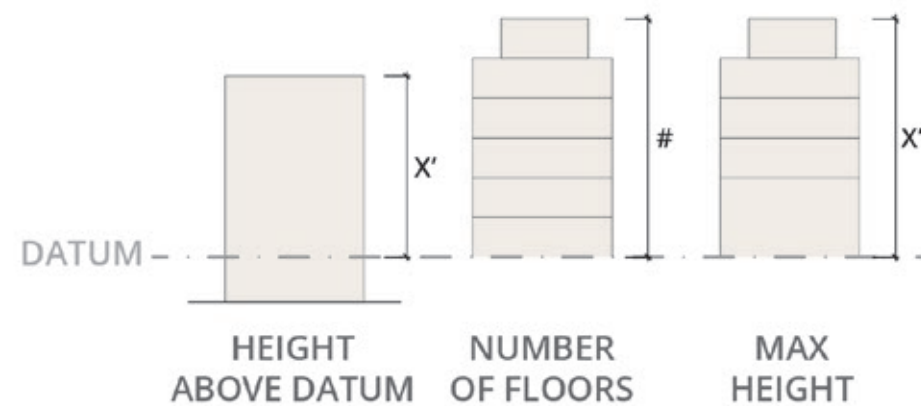

Methods for Determining Building Heights

3.8 - ROOFTOP EQUIPMENT:

The consolidation and screening of rooftop mounted equipment is required. The significant quantity and magnitude of stacks, exhausts and equipment must be collected and screened within a designed roofscape. The nature and scale of the roofscape should attempt to mitigate the magnitude and diversity of equipment while developing engaging relationships between the building and the sky.

For equipment not housed in enclosed penthouses, line-of-sight studies should be conducted from all likely vantage points. Occupant views in adjacent buildings will also be taken into consideration in determining the optimal location and screening of equipment.

The proximity of buildings and the nature of functions may require additional study and modeling to evaluate exhaust plume and prevent re-entrainment to neighboring facilities. Research facilities with potentially significant exhaust requirements and equipment will strive to maximize screening of exhaust hoods from view.

3.9 - ACCESSIBILITY:

All new construction and major renovations must comply with American with Disability Act (ADA) requirements, other applicable accessibility codes, and should strive to use universal design principles. Consider placing classrooms and labs with high utilization on lower levels to accommodate class changes.

Finished floor levels should be established at grade at the primary entry and primary paths of travel. Sites with significant slope shall elegantly transition the grade to support enhanced accessibility, utilizing the slope changes to the advantage of the building program and vitality of the adjoining exterior open spaces.

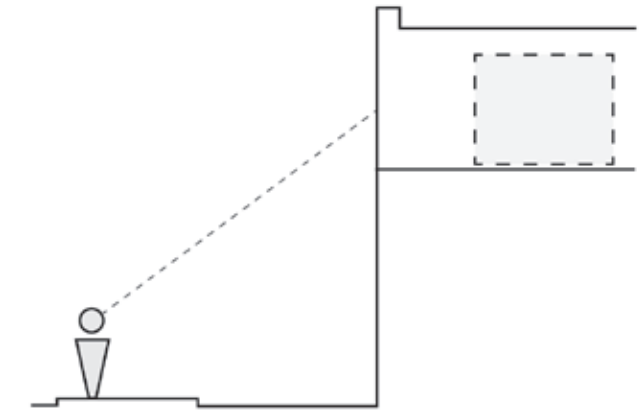

Enclosed Equipment - Preferred Option

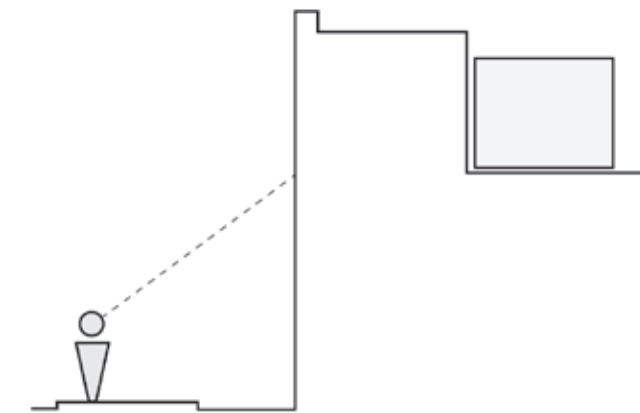

Screened Equipment - Alternate Preferred Option

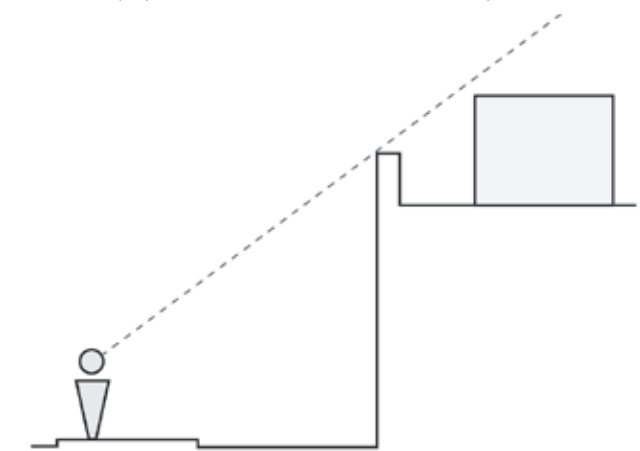

Exposed and Setback Equipment - Discouraged Option

Principle - 04
Character Zone Parameters

This principle acknowledges the presence of significant diversity in the built environment across the Campus and establishes appropriate parameters for integration of projects in the existing context.

The varying physical characteristics of campus were used to define and group like conditions into the thirteen Character Zones. Three particular characteristics relevant to the guidelines are distinct to individual zones. These included:

- Density of Development
- Building Heights
- Building Materiality

The following tables and diagrams illustrate the distinction between zones.



Character Zone	Planned Density	Allowable Building Height By:			Materials
		Number of Floors	Maximum Measured Height	Height Above Datum	
Northside	1.00	05-07 stories; 07-stories at University Drive, 05-stories at Ross Street; Buildings on Ross Street not to exceed height of J.K. Williams Building	105'-0"		Building near Ross Street should be primarily of brick and limestone with limited metal panel and large glazing areas. Moving north the quantity of metal panel and glazing area may increase nearer to University Drive.
Historic Core	1.00	03-05 stories; Buildings in the environs of J.K. Williams Building shall be shorter than the primary roof line of J.K. Williams Building	75'-0"		Buildings should be primarily brick and limestone. Metal panel and large glazing areas used sparingly.
Southside	1.00	03-05 stories	75'-0"		Buildings should be primarily brick and limestone. Metal panel and large glazing areas used sparingly.
Campus Front	0.50	03-05 stories; 5-Stories at University Drive, 3-Stories at Bonfire Memorial	75'-0"		Buildings can include a combination of brick, limestone, metal panels, and large areas of glazing. Limestone must be present.
Athletics and Recreation	0.25	03-05 stories	75'-0"		Buildings can include a combination of brick, limestone, metal panels, and large areas of glazing; Limestone must be present. Precinct context includes areas of Northside Character Zone immediately adjacent to University Drive.
West Campus	0.50	05-07 stories	105'-0"		Buildings can include a combination of brick, limestone, metal panel, and large areas of glazing. Limestone must be present.
Research Park	0.50	05-07 stories	105'-0"		Buildings can include a combination of brick, limestone, metal panel, and large areas of glazing. Limestone must be present.
Hensel Park	0.10	01-03 stories	45'-0"		Buildings should be primarily brick with limited amounts of metal panel and stucco (for housing) allowable. Limestone should be present.
University and Agronomy	0.15	03-05 stories	75'-0"		Buildings can include a combination of brick, stone, metal panel, and large areas of glazing; Limestone must be present.
F & B Road	0.01	01-03 stories	45'-0"		Primary material context is the Equestrian Center.
Health Sciences Campus	0.35	03-05 stories	75'-0"		Buildings should be primarily brick and limestone; Metal Panels and large areas of glazing can be used sparingly. Precinct context includes the Historic Core and Southside.
Campus Entry and Golf Course	0.04	03-05 stories	75'-0"		Buildings should be primarily brick and limestone. Metal panel and large areas of glazing can be used sparingly.
Bush Library	0.08	01-03 stories	45'-0"		Material palette is primarily brick and stone with some areas of large glazing.

Principle - 05 Sustainability

These guidelines overlay project-scale sustainability considerations to support high-performance buildings through both passive and active strategies along with integrating campus-wide sustainability initiatives. Guidelines forming part of Principle – 01 include:

- 5.1 Building Performance
- 5.2 Passive Design
- 5.3 Massing & Orientation
- 5.4 Building Envelope
- 5.5 Space Planning
- 5.6 Material Life Cycles
- 5.7 Accessibility
- 5.8 Campus as Laboratory
- 5.9 Campus-Wide Initiatives

5.0 - INTRODUCTION:

Texas A&M University's integrated approach to sustainability extends to all areas of the 2017 Campus Master Plan and as a result not all content about a sustainable campus resides within this chapter. Much of this Campus Master Plan's sustainability content lives in Chapter Five, including information on energy use and greenhouse gas reductions from a utility infrastructure standpoint, waste management, and non-operational items including social sustainability, strategies for outreach and engagement, and administrative support. Stormwater management is dominantly communicated in Chapter Five, but the plant list provided within this chapter's landscape guidelines should be consulted to validate softscape selections. Mobility content is communicated largely in Chapter Four although the site and landscape section within this chapter should be referenced for information on hardscape design.

Within the Campus Guidelines, Texas A&M University's sustainability discussion is focused on project-scale considerations of both buildings and site. This information necessarily overlaps into content presented elsewhere, most specifically in the discussion of accessibility and how outreach, engagement, and education, pedagogy, research, and innovation are evident in the campus environment.

At its broadest brushstroke, future campus development is obligated to consider that environmental, social, and economic conditions evolve and resiliency in the face of these known and unknown changes supports the continuation of Texas A&M's campus legacy. As its own energy and water utility, the failure of individual projects to minimize energy and water demands has an institutional impact that requires Texas A&M to allocate funds for infrastructure projects that can accommodate wasteful building-scale projects. This is not economically sustainable nor the highest and best use of physical and economic resources. Each project must make its contribution to treading lightly upon the land by minimizing stormwater runoff, peak and overall energy demand, and potable water consumption.

5.1 - BUILDING PERFORMANCE:

There are many metrics by which to measure a building's performance including LEED or other green building rating system certifications, energy use intensity (EUI, measured in kBtu / sf / year), greenhouse gas emissions (measured in metric tons of CO₂), gallons of potable water used, percentage of occupants satisfied with the indoor environment, number of service calls required per year, and others. Texas A&M's UES Guidelines state that projects are to be LEED Silver equivalent but may or may not be certified by the Green Building Certification Institute (GBCI). At the time this guideline was articulated, GBCI certified project under LEED 2009, but this system sunset on October 31, 2016 and was replaced by LEEDv4, a significantly more robust green building rating system. Developing LEEDv4 Silver equivalent projects may or may not be appropriate to Texas A&M's performance objectives and the institution must determine what elements of LEED 2009, LEEDv4, and SITES are appropriate for future campus development. Chapter Five articulates the institution's need to develop an enforceable set of performance criteria and outlines the scope of what those criteria should cover.

Beyond what's included in Chapter Five's design criteria, there are cost-effective design strategies that can significantly impact a building project's ongoing demand for resources and capacity to meet human needs in operation:

5.2 - PASSIVE DESIGN:

Passive design strategies leverage local climate conditions to generate the indoor environment desired by occupants. Because these strategies use local climate conditions instead of energy-using active systems such as HVAC and electric lighting, using passive design thinking to solve a design problem can significantly reduce the energy required to maintain an appropriate indoor environment. College Station, Texas is admittedly a rather harsh environment – the weather rarely support passive thermal comfort – but using strategies such as thermal mass can shift a building's peak power demand and allow

the University to avoid expensive midday energy prices. Daylighting, if appropriately controlled from the exterior, can also minimize the need for electric lighting during the swing seasons while still avoiding overheating in summer and glare in winter.

5.3 - MASSING AND ORIENTATION :

Appropriate massing and orientation costs no construction dollars but pays significant dividends in ongoing operational expenses. In College Station, and anywhere else in the northern hemisphere, the sun rises in the east, sets in the west, and moves across the southern sky. Solar angles vary from high in summer to low in winter. Consider how daily and annual solar cycles will compare to daily and annual building operation – will offices be occupied before solar heat gain can warm them from night setback conditions in winter? Will courtyard spaces be shaded in hot summer months to make them desirable places? Do major openings occur on the west elevation that will add excess heat gain in the late afternoon? Consider the relationship between orientation and the campus environment and work to align long elevations with the more environmentally stable southern and northern facades. Respond to local climate by developing massing schemes that minimize the square footage of building envelope to the interior square footage required. Exterior envelope that can protect indoor environmental conditions from the exterior environment is expensive and the extent to which a massing can stay compact can significantly affect energy performance. Compact buildings need not sacrifice daylighting and should consider opportunities for light wells and atria to minimize electric lighting.

5.4 - BUILDING ENVELOPE :

Develop air tight building envelopes that minimize thermal bridging. Pay attention to the interfaces of various materials and verify all components of the weatherproofing envelope are compatible. Simple massings with fewer concurrent intersections are easier to detail in contract documents and build in the field; avoid the intersection of multiple material interfaces in close proximity to one another. Consider how major areas of glazing will respond

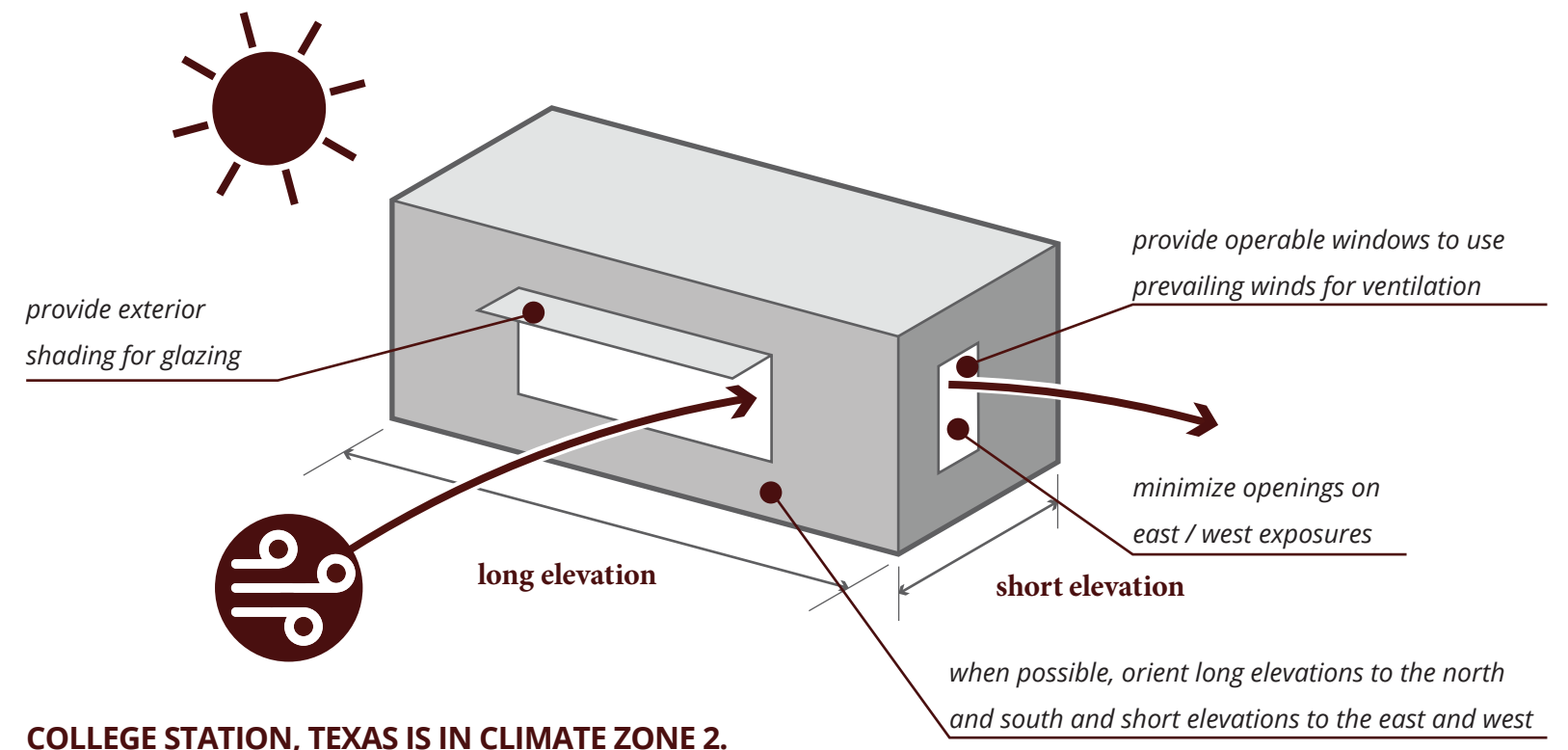

Passive design strategies can help Texas A&M can reduce energy demands while maintaining thermal comfort.

to climactic conditions. Minimize glazing on the east and west elevations. Solar heat gain tends to be most extreme on the west elevation and in College Station's generally hot climate requires significant upsizing of HVAC equipment to maintain thermal comfort inside the building. Alternatively, thermal mass on the west elevation such as thick concrete or masonry walls has high thermal energy storage capacity and can release midday heat later in the evening when a building may have fewer internal loads or occupants to support.

Where large expanses of glazing are programmatically appropriate on any exposure, consider how to shade it outside the building envelope using the building mass, overhangs, and/or fins. While interior roller shades allow individual occupants to manage daylight to meet their needs and preferences, a roller shade still permits solar heat gain into the building that must be

managed by the HVAC system. Exterior shading systems keep solar heat gain out and can minimize the demand for energy-intensive cooling systems. While it can impact a project's first cost, investing in the highest performing glass possible is the single greatest determining factor of how well a building envelope manages indoor environmental conditions.

5.5 - SPACE PLANNING:

Matching program requirements with appropriate orientation and massing can reduce energy use and increase thermal comfort. Consider the energy intensity of building programs in multi-use construction. Laboratories, for example, are particularly energy intensive and coupling their high internal energy demands with western exposures that demand significantly greater HVAC systems to manage overheating exacerbates thermal comfort issues. Work to locate spaces with wider thermal comfort ranges or that are heating load dominant on western or southern exposures; conversely work to place cooling load dominant spaces on northern and eastern exposures. At a building scale, plan to include a vestibule to minimize the transmission of outdoor thermal conditions to the interior. Vestibules may also be useful within a building if discrete spaces require substantially different environmental conditions than their surrounding environment.

Take advantage of consistent midday sunlight and organize floor plates to maximize the number of regularly occupied spaces that will have access to daylight. Place circulation areas and service spaces toward the light-locked core of the building with the exception of building lobbies. Skylights and tubular redirection devices can bring light to the center of wider floor plates. During a project's development, the design team should model daylighting to demonstrate to Texas A&M how daylight will meet lighting needs before construction.

5.6 - MATERIAL LIFE CYCLES:

Including recycled content, sourcing materials locally, and diverting construction wastes from landfills have become increasingly common

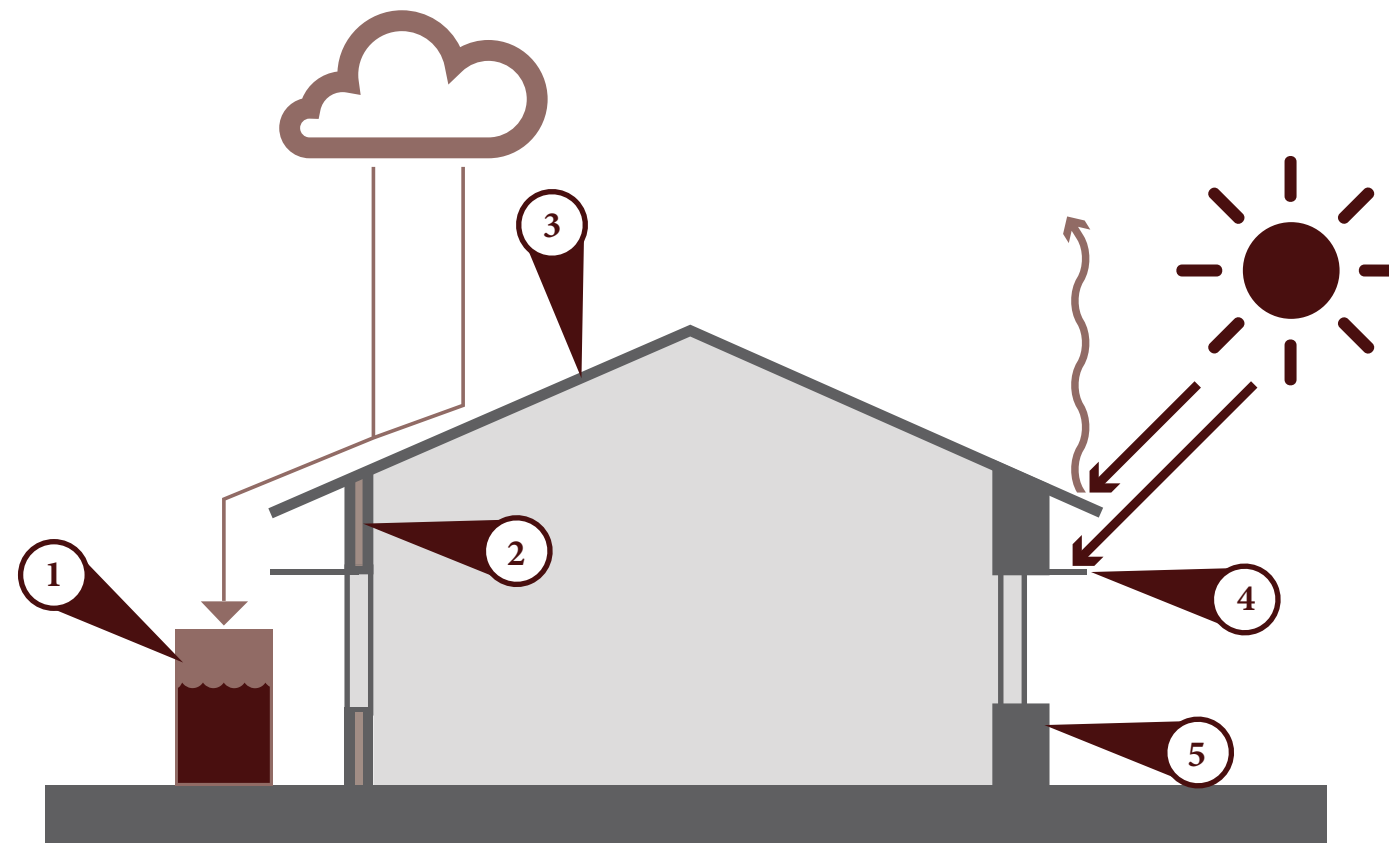

1. Integrate a low-slope roof with a water collection system to serve the project during droughts.
2. Layered wall assemblies manage the broad range of moisture levels, rain, and temperature in College Station.
3. A high SRI roof minimizes solar heat gain. Sloped roofs shed water.
4. Shading devices keep summer sun out, allow winter sun in.
5. A thermal mass envelope keeps midday heat out and slowly releases it into the building during cool nights.

in the construction industry and have gone a long way to reducing the environmental impact of building. From a design perspective, architects can further minimize the material impact of construction by using building components in industry standard sizes and limiting custom-build approaches.

In addition, all materials and products have a useful lifespan after which they require maintenance and/or replacement. Specify durable products with long life cycles to minimize the frequency of replacement. Consider what maintenance a product will require and what impact that has on Texas A&M's operating budget. Verify that maintenance personnel for various systems are present in the local labor pool. For assemblies that age at different rates, verify that the shortest lifespan product can be repaired or replaced without damaging those with longer lifespans. Preference materials whose end-of-service life outcome is something other than the landfill. Look for manufacturers with material recapture programs and recyclable materials.

5.7 - ACCESSIBILITY:

The implementation of universal design standards that support those of all abilities in using University facilities will support the institution's mission to develop an inclusive, equitable, diverse campus. Information is provided in Chapter Five regarding how Texas A&M intends to incorporate universal design standards in renovations and new construction.

5.8 - CAMPUS AS A LIVING LABORATORY:

Sustainability initiatives are an excellent opportunity for the university to use all 5500 acres of campus as a classroom. Buildings that put services on display allow the campus community to understand how the indoor environmental conditions they need to engage in their activities are created. Celebrating technical programs such as engineering labs or media classrooms allows students, faculty, and staff of different disciplines to engage with others outside their field of study and breaks down academic silos to create a more equitable and inclusive campus environment. Intentionally crafting spaces for public gathering encourages community building – Texas A&M

prioritizes the creation of spaces that support communities large and small in meeting, celebrating, conducting civic and academic discourse, and growing together as Aggies. Sustainable building features including stormwater management features, rainwater catchment, and native landscaping are all opportunities for tasteful interpretive signage.

To stay on the cutting edge of high-performance building design and construction, Texas A&M should continue to embrace innovation and managed experimentation in renovations and new construction. Building science is evolving quickly and while not every new technology is appropriate for Texas A&M, some will have synergies with campus programs in design, engineering, and construction research that can further the institution's academic mission.

5.9 - ENGAGE WITH CAMPUS SCALE INITIATIVES:

Campus scale initiatives require buy-in and support from building-scale projects. Efforts to maximize waste diversion will fall short if buildings do not provide adequate recycling infrastructure in high-traffic areas. Transportation initiatives to support a more pedestrian- and bicycle-oriented campus will be unsuccessful if new construction and major renovation projects do not incorporate appropriate end-of-trip facilities such as bicycle racks, showers, and changing rooms. Landscape and building maintenance activities are not sustainable if access is not readily available.

Consider how the project support initiatives documented throughout this Campus Master Plan update and what can be done ensure the success of broader initiatives across campus. No building at Texas A&M University exists within a vacuum and each has a small role to play in creating the university Texas A&M wants to be. Provide campus standard recycling infrastructure and ensure building-scale waste management is easily accessible. Support pedestrians and bicycles by providing end-of-trip amenities. Collaborate with maintenance staff during the design process to accommodate regularly required access points.

Principle - 06

Integration with Site and Landscape Guidelines

Interlinking the guidelines contributes to a cohesive and supportive built environment that blurs the boundary between inside and outside. Guidelines forming part of Principle - 01 include:

6.1 Building vs. Project Boundary

6.2 Activated Ground Plane

6.3 Entrances & Plazas

6.4 Colonnades & Connections

6.5 Shade

6.0 - INTRODUCTION:

A well-developed and thoughtful integration of Architectural and Landscape design for projects is an eminent device for the creation of a memorable and positive campus experience. The landscape and building should be programmed, conceptualized and designed as a single composition. Projects shall provide strong physical and visual connectivity between indoor and outdoor spaces such as entries, lobbies, circulation routes and social gathering spaces. Linkages will be incorporated by use of programmatic and physical elements that support and enhance the activation of adjacent exterior and interior spaces. Clearly defined entry locations and access will align with the Campus Development Framework and Open Space Network while relating to adjacent facilities. In addition to circulation, colonnades, loggias, overhangs, and shaded outdoor spaces contribute greatly to thermal comfort on the campus.

6.1 - BUILDING VS. PROJECT BOUNDARY:

Addressing the space between the buildings has been a major theme for the update process, and many of the elements support this concept such as the open space network, siting guidelines, and heavy emphasis on programming landscape areas on campus. The project boundary for new buildings and major renovation differs from the building boundary. The project boundary is a larger footprint and incorporates landscape and open space into the overall scope of a building project.

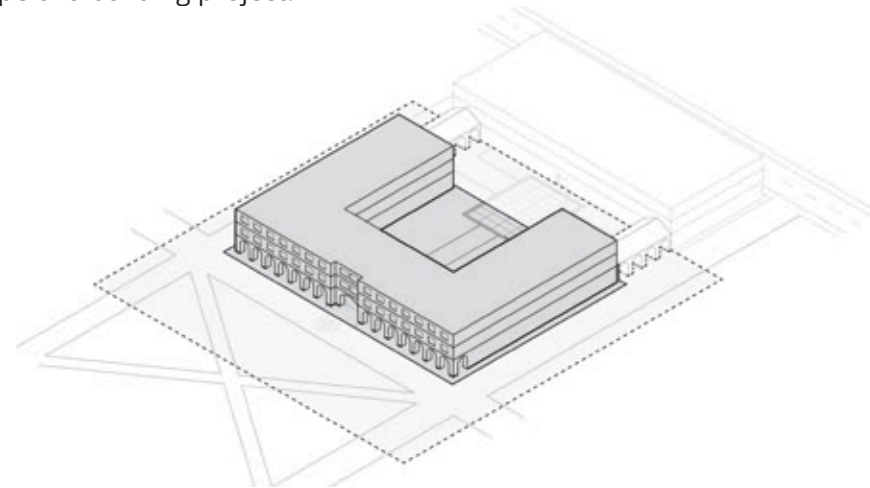

Building vs. Project Boundary Diagram

6.2 - ACTIVATED GROUND PLANE:

Use a seamless ground plane to absorb contextual architecture. A similar ground plane palette across all of campus creates a cohesive experience for pedestrians across campus and supports an energetic campus environment. Active program uses such as lounges, stairs, and appropriate group conference space should be located at or near the ground plane for both convenience and visible activity. In addition, outdoor gathering spaces should also be placed along pedestrian paths. This can decrease the perceptual distances across campus. Service functions have been located off of the main pedestrian routes to minimize inactive or unfriendly uses at grade level.

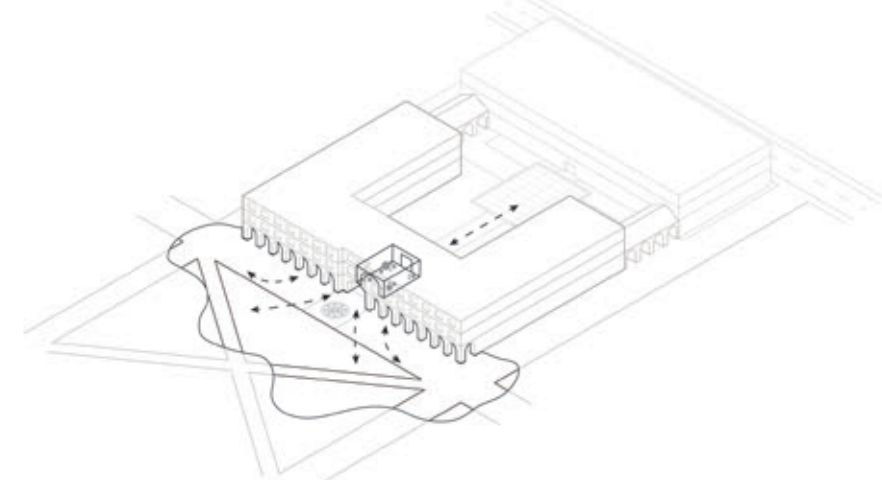

Activated Ground Plane Diagram

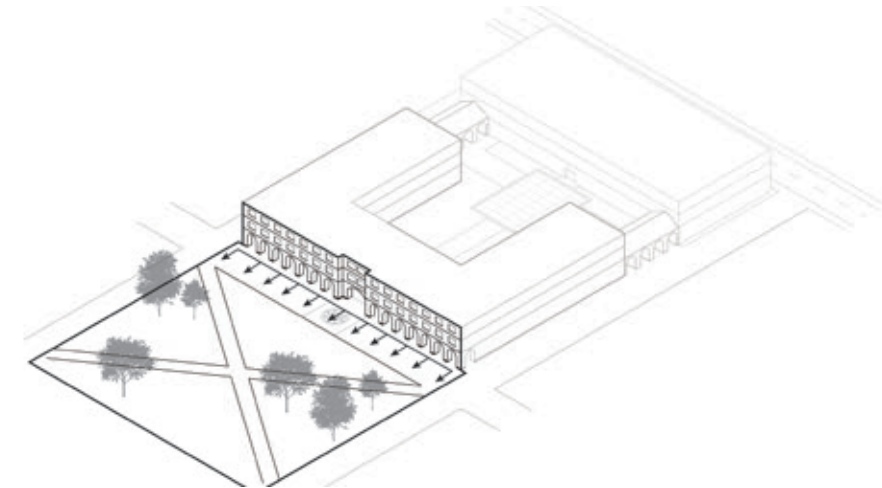

Activated Ground Plane Diagram

6.3 - BUILDING ENTRANCES AND PLAZAS:

Because all new buildings should be placed along major pedestrian routes, primary buildings entries, courtyards and lobbies have the ability to activate and become extensions of internal campus connections.

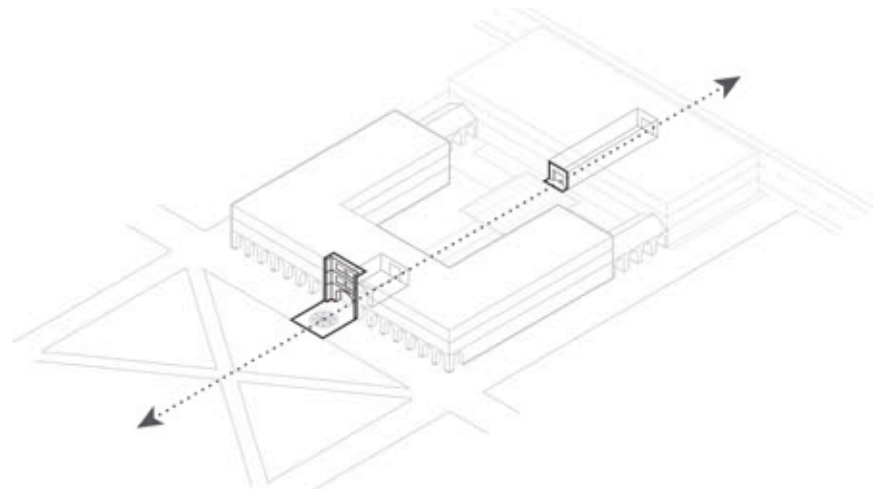

Entries and Plaza Diagram

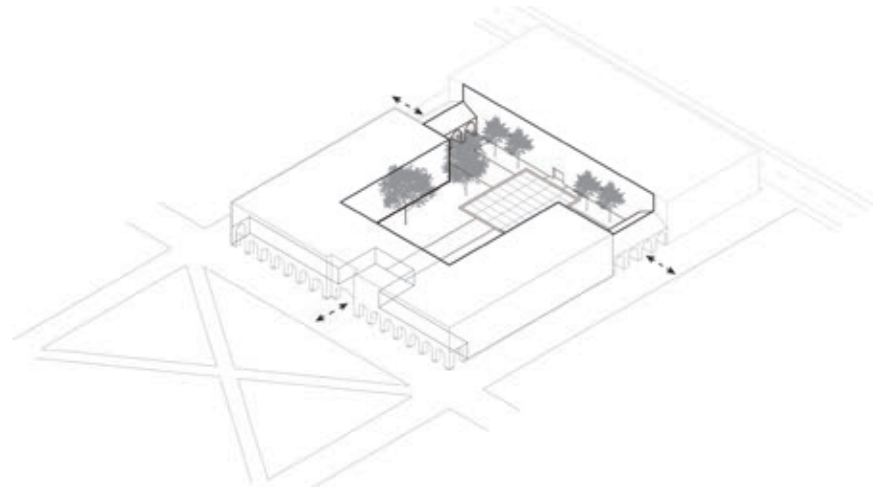

Entries and Plaza Diagram

6.4 - COLONNADES AND OUTDOOR CONNECTIONS:

As an extended portico, a colonnade composes columns or piers to support horizontal elements including an entablature or multiple arches. This architectural device defines entries, provides shaded connections, reinforces the horizontal building base and captures desirable indoor-outdoor space. As circulation elements, loggias provide shelter and ease the transition between inside and outside. New buildings should use colonnades, arcades and porticos when appropriate, especially to connect with landscaped open spaces and walkways.

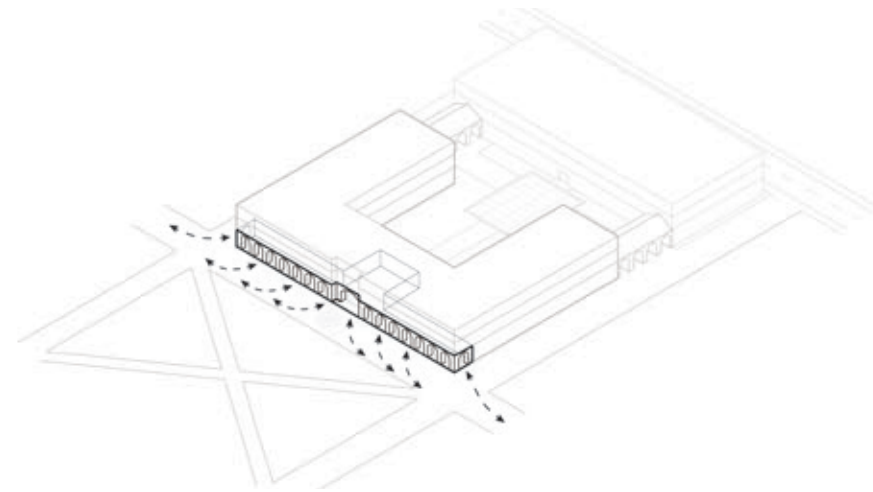

Colonnade and Connections Diagram

6.5 - SHADE:

Elements providing shade can represent architectural or landscape elements and should be incorporate across a broad spectrum of projects to provide respite from climatic conditions.

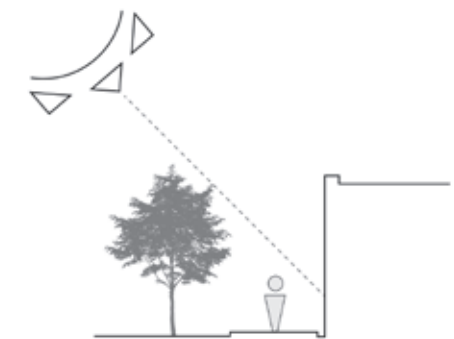
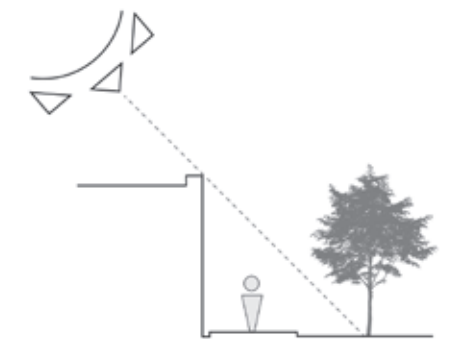
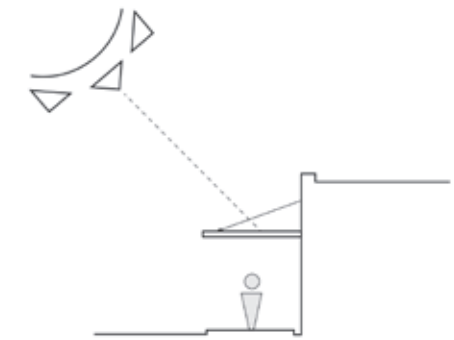
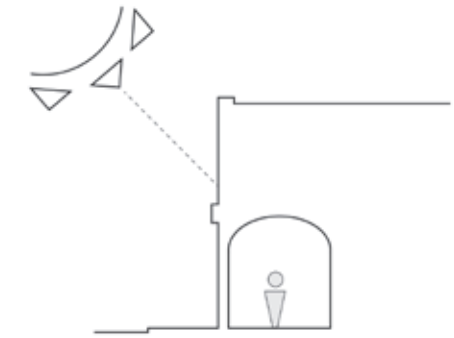

Shade Diagrams

Activating the exterior ground plane through unified design and improved pedestrian experiences strengthens the broader landscape's cohesion and elevates the campus to a thriving, environmental asset for the University.

A major driver for the 2017 Campus Master Plan is a commitment by the University to improve the campus landscape by strengthening its overall cohesion. In the natural environment, activating the exterior ground plane through unified design and improved pedestrian experiences strengthens the broader landscape's cohesion and elevates the campus to a thriving, environmental asset for the University. This chapter uses the broader term "landscape" to define the outdoor environment where the "softscape" (vegetative materials) and the "hardscape" (construction materials - including paving, site or garden walls, site furnishing, lighting, etc.) come together through design to form the campus' natural outdoor setting. Incorporating a strategy of consistency through softscape and hardscape materials provides clear continuity, builds a stronger campus identity, while still allowing for occasional variety in the landscaping.

The focus of the Guidelines is to create a series of energized spaces with a cohesive, yet appropriately diverse, palette. This chapter defines the overall network of open spaces and their connections, program types for open spaces, design concepts to enhance the existing landscape, and appropriate softscape and hardscape amenities and details. The goal is to achieve a comprehensive landscape design that is economical, practical to maintain, responds to functional and environmental constraints, and where all parts of the broader campus landscape relate to each other to establish an integrated whole.

The six Site and Landscape principles include:

Define the Open Space Network through the Site and Landscape Guidelines. This principle seeks to form an expanded and enhanced Open Space Network by identifying both the primary uses for spaces and the amenities and details that support these uses.

Create connective spaces that facilitates movement in a seamless and intuitive experience. The campus landscape should support pedestrian activity through linkages and gathering areas which ease the transition between indoor and outdoor spaces.

Use consistent site amenities and landscape details to build a strong campus identity. This principle seeks to create a sense of orderliness and cohesive campus identity by establishing a reference vocabulary of softscape and hardscape materials and their application.

Craft open space to create purpose, intent or program. As the campus develops, open spaces will be defined and developed into specific uses including connections, linkages, large and small gathering areas, educational and recreational spaces.

Support the campus sustainability strategy through plant selections. Implementing low-impact landscape design strategies across campus is one of the best ways that Texas A&M can preserve and improve its natural resources and landscape environment.

Plan for maintenance and resiliency in landscape design. It is critical to anticipate potential post care and/or resource limitations while selecting the most appropriate softscape and hardscape materials.

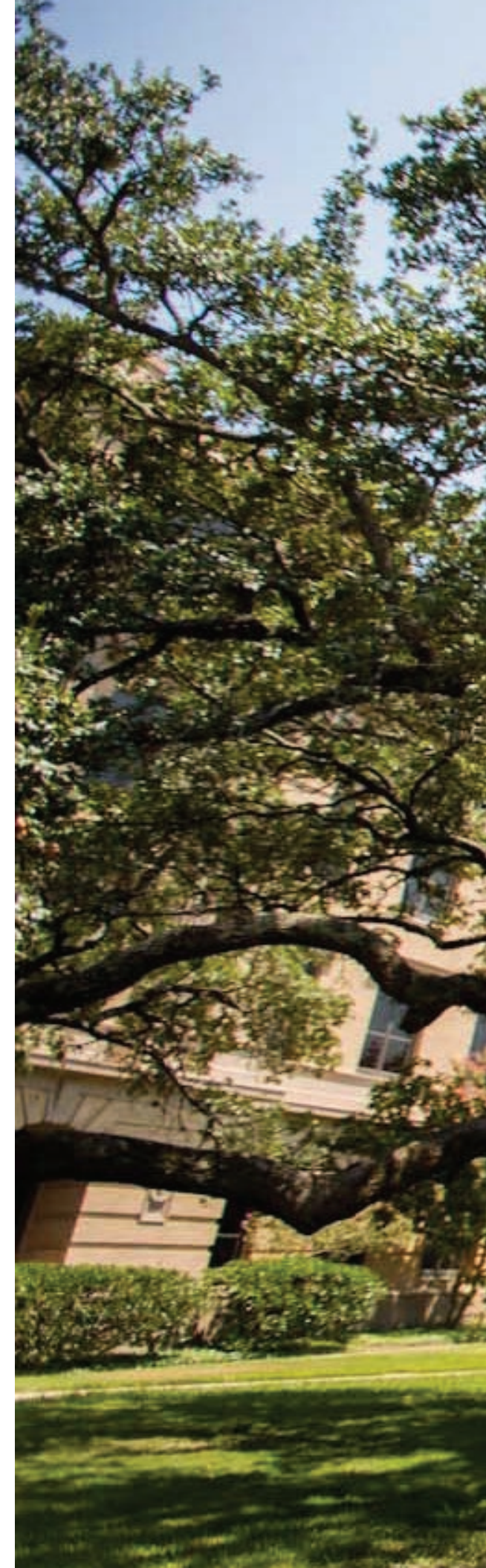



Site and Landscape Principles

1. Define the Open Space Network through the Site and Landscape Guidelines.
2. Create connective spaces that facilitate movement in a seamless and intuitive experience.
3. Use consistent site amenities and landscape details to build a strong campus identity.
4. Craft open space to create purpose, intent or program.
5. Support the campus sustainability strategy through plant selections.
6. Plan for maintenance and resiliency in landscape design.

Campus Wide: Open Space Network

The combined built and non-built areas of campus define Texas A&M's Open Space Network. It is comprised of a variety of scales, uses, and physical elements that collectively define a diverse set of landscape typologies, resulting in the campus' identity and character as experienced by students, faculty, staff, and visitors. The campus contains numerous open spaces where clear programming and thoughtful material selections support functional and enjoyable engagement between landscape and the end users. Spaces such as Hullabaloo's courtyard, Memorial Student Center's and Kyle Field's commons, and Academic Plaza are all positive examples of the symbiotic relationship between place and people.

Reversely, there are also open spaces within the campus network that are essentially "leftover" space with no clearly identified programs or appropriate levels of amenities and details to support potential users. As Texas A&M's density and campus body grows, it is no longer feasible to neglect these spaces and purposeful programming and thoughtful design must bring these "leftover" spaces into the campus fold instead of allowing them to detract from the landscape's unity. This Open Space represents prime areas for development, which over time will create new programmed open spaces supported and reinforced by future campus buildings. As the campus grows and expands, the amount of unassigned open space will be redefined and developed into new quads, malls, courtyards, and educational and recreational spaces. As these new spaces are designed and implemented, it's essential that solid campus guidelines are in place to ensure softscape and hardscape cohesion.

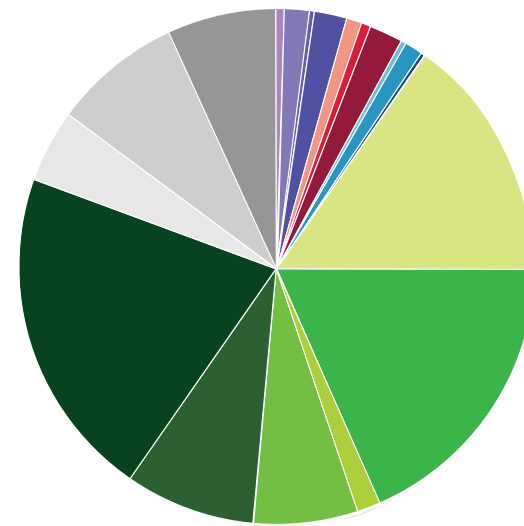

Framework Chart Key

Mall	9.93 AC
Connectors	44.88 AC
Urban Edge	6.06 AC
Boulevard	64.81 AC
Civic	24.79 AC
Campus Quadrangle Greenspace	15.63 AC
Pocket Park	47.84 AC
Courtyard / Building Entry	7.29 AC
Rooftops	27.98 AC
Recreation	0.41 AC
Buffer Spaces	275.59 AC
Park	19.20 AC
Educational Open Space	42.85 AC
Unprogrammed Open Space	196.37 AC
Natural	116.62 AC
Surface Parking	67.63 AC



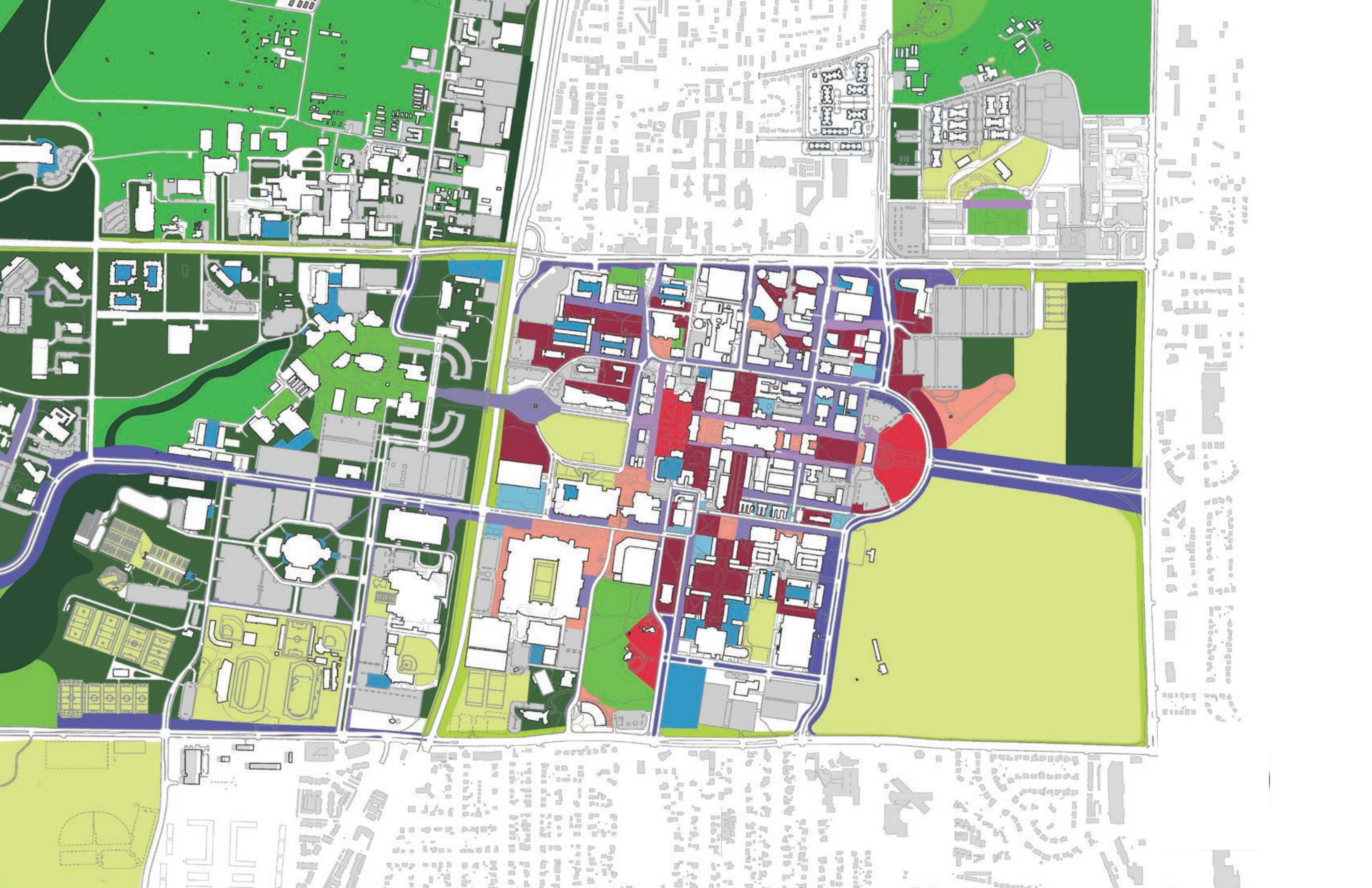

As a reflection of the University's values, Open Spaces sets the tone for a visitor's first impressions of the campus. In conjunction with feedback from extensive campus engagement, this has encouraged the utilization of the Open Space Network as the primary tool to direct future planning. This also closely aligns with the goals of the Mobility and Safety Chapter, which seeks to elevate the current campus access and circulation along with projected scenarios based on potential growth, while emphasizing the pedestrian experience along with campus gateways, edge conditions, alternate mobility opportunities, future garage locations, and connections to the community.

The Campus Master Plan establishes and outlines the programs, amenities and details necessary for successful open spaces. Open space programs identify primary uses for spaces, while the amenities and details outline the necessary physical characteristics that support these uses. Together, these forms of structure achieve an expanded and enhanced Open Space Network.



Memorial Student Union/Rudder Tower Plaza



Academic Plaza



J. K. Williams Administration Building East Lawn



Courtyard at Hullabaloo Hall



Kyle Field Plaza

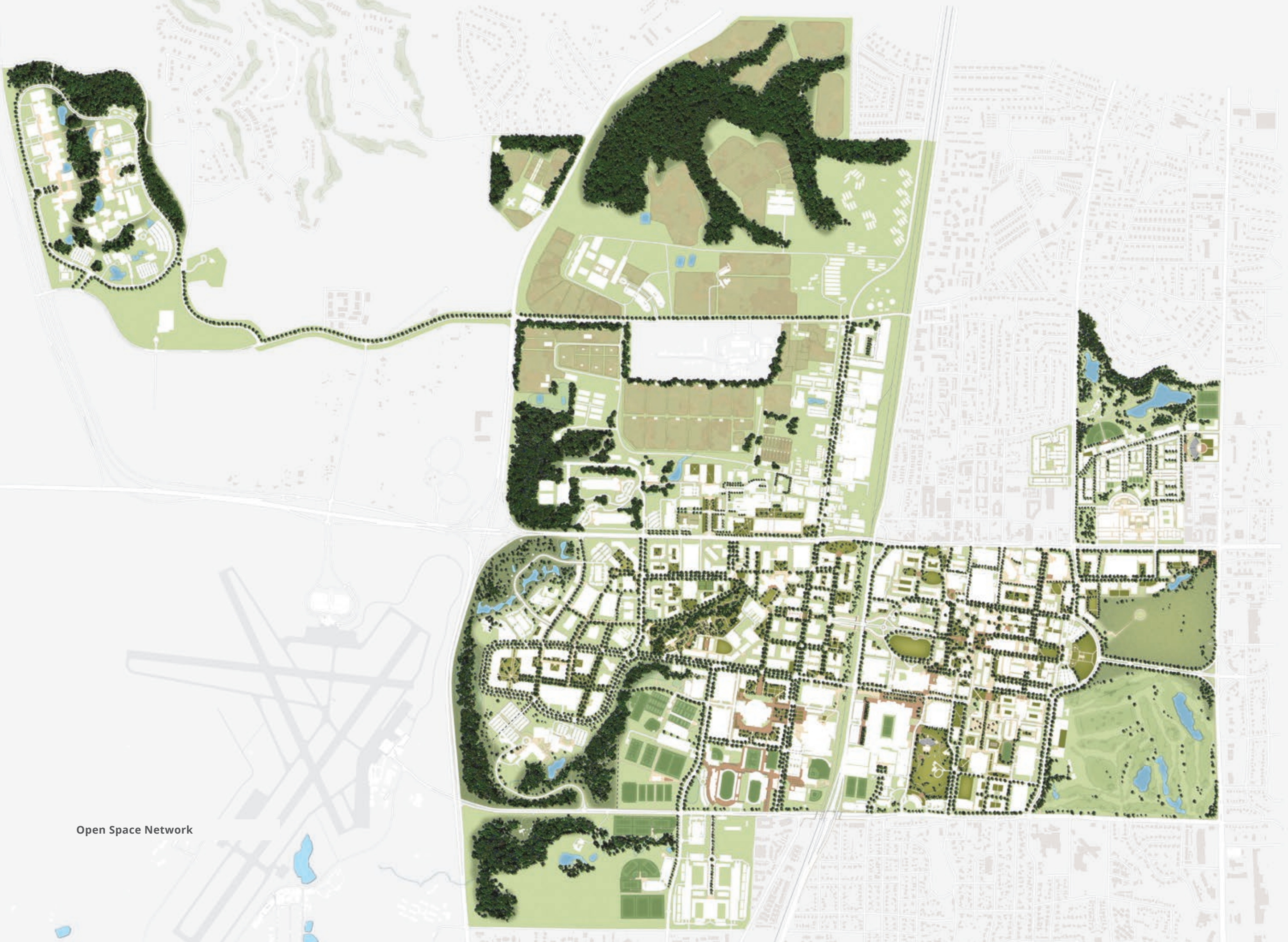

Open Space Network

Connections and Linkages

The campus landscape should support pedestrian-centered movement through linkages and gathering areas which both facilitate movement across campus and ease the transition between indoor and outdoor spaces.

Campuses are inherently busy spaces, and large numbers of people, bicyclists, vehicles, and buses regularly move around and through them. Whether it's a typical school day where students are crossing from one side of campus to another to reach their classes or it's a home game day where 100,000 Texas A&M fans have gathered to support their team at Kyle Field, it's critical that clear routes with strong connections and linkages are present in the ground-level design.

People movers are a series of paths, sidewalks, malls, and other connective spaces that facilitate movement across campus, helping to create a seamless, conflict-free pedestrian experience, while eliminating confusion with clear orientation and circulation. Hierarchy delineates main pedestrian thoroughfares from smaller pedestrian connectors and multi-modal connections for bus and bicycle users. Surface treatments, such as hardscaping, connector width, amenity and detail selections, and aesthetic articulation of these connective spaces, can also help define the hierarchy and strengthen the understanding of whether the path leads one across a campus mall or through a pocket park.

Campuses are also essentially 24-hour places, and safety for all users is paramount. Therefore, proper lighting is critical to keep connections and linkages safe and desirable. Properly scaled lighting is critical, and pole and path lighting should be used in conjunction with the adjacent site to determine proper scaling and ensure that passages are safe throughout evening hours. Campus standards have already been established in regards to site lighting and can be found in the Utilities and Energy Services' *Exterior Lighting and Installation document*. More information can be found at <https://utilities.tamu.edu/>.



Open Space Network: Linkages and Connections



Military Walk



Underpass at Old Main Drive and Wellborn Road

The moderate climate in College Station allows for students to spend time outside in the natural environment while studying, gathering or moving from building to building. Easing the transition between indoors and outdoors can create a more seamless and comfortable experience for users. In the built environment, this is achieved by activating the interior ground floor spaces, providing seamless pedestrian walks with gathering areas, and easing the transition between indoor and outdoor spaces through colonnades and entry courtyards. In the natural environment, activating the exterior ground plane through unified design and improved pedestrian experiences strengthens the broader landscape's cohesion and elevates the campus to a thriving, environmental asset for the University.



Rendering: Proposed Interstitial Space at Commons/Corps of Cadets

Landscape Amenities/Details

Consistency and continuity are keys to establishing a pleasing landscape. Repetition in softscape and hardscape materials and their application can provide a sense of orderliness. The intent of the Guideline is to set up a reference vocabulary that is consistent across the broader campus landscape to build a stronger campus identity. Taking the different character zones and their associated architectural style into account, the landscape becomes the glue, adhering buildings and site together. The following prescribed softscape and hardscape amenities and details attempts to achieve a cohesive landscape that enhances and strengthens the hallmark of Texas A&M's campus.

Softscape

The goal of the softscape is to enhance the natural and designed beauty of the campus landscape. Strengthening the softscape spaces across campus, particularly in key campus locations that make the best "first impression," ensures that visitors and potential students, who have 30-60 seconds to make up their minds about the campus' "nice" or "not nice" factor, have a positive first experience. This can best be achieved by broadening the plant palette (see Plant List XX) beyond the current mono-culture of live oaks, Asian jasmine, and Bermuda grass and embracing a much larger and diverse Texas native and adaptive plant palette ("native" and "adaptive" defined on page XX). Such diversity, within a structure of continuity, has the ability to enhance the overall foundation, beauty, and resiliency of the campus landscape.

The recommended plant palette has been broken down into 75% and 25% categories. The goal is for the broader campus landscape structure to come from the 75% plant list, ensuring visual continuity as well as improving the strength and longevity of the landscape through plant material that is best suited for the challenging campus environment. The 25% plant list is for small gathering areas, or "special spaces," where unique areas with site specific soft and hard scape materials bring diversity to the campus outdoor experience.

These plants may need additional maintenance or micro-climate zones where they can be featured as specialty plantings.

Additionally, the softscape amenities and details include industry-wide best practices that ensure the health of the campus' environment. Specified plantings that are well suited for the campus ecoregions, of high quality and sourced from reputable nurseries or growers, and maintained through a program that includes regular organic material and fertilizer application ensure that the softscape thrives and is best able to counter any overuse due to the volume of people who regularly engage with the campus landscape.

Hardscape and Site Furniture

Material continuity plays a major role in the structure of the broader campus environment. As such, products and material choices that differ in color, style, and construction highlight a lack of cohesion. When these differing elements are adjacent, it can be particularly confusing and undermines the desire for order and ground plane structure. A palette that upholds the designated campus standards for items such as paving, site or garden walls, site furnishings, and lighting helps strengthen visual order on the campus, allowing students, faculty, staff, and campus visitors to easily recognize boundaries, transitions, and programs for any campus space, small or large.

Hardscaping "harmony" should be achieved through consistency and a sensitivity to scale, materials, pattern, texture and form, thus enhancing the balance between variety and unity. Additionally, hardscape materials must be functional, economical, of quality, and dovetail with the spirit of sustainability that the campus strives to achieve as stewards of its built and natural environments.



Rain Garden at Mitchell Physics



Pavers at Corps of Cadets Quad



Outdoor Seating at Residence Hall

Standard site furnishings, which include benches, tables, shade structures, lighting, etc. are an integral part of the development of campus streets, open spaces, and pedestrian zones for a consistent campus character. These items should be consistently applied throughout the campus with the exception of areas of historical significance or a unique program may have unique site furnishings specific to the character of those spaces.

Utilities

Complete coordination between all parties before installation/construction of utilities is essential. All utilities, such as manholes, underground utilities, and overhead utility lines, must be accurately and precisely located and identified. This will avoid having to make impromptu field decisions that may compromise the quality and intent of the design, the health of planting material, or the structural integrity of hardscaping material.

Because most utilities are found underground, repairs on utilities require soil excavation usually around or near trees and plantings. As underground utilities age, the frequency of excavation increases due to repairs or replacement. As trees age, their root systems expand placing them at greater risks of damage from construction activities. Severed roots, mechanical damage, and compaction caused by these activities, greatly decreases the life span of the trees.

Proper planning can greatly reduce the damage to existing trees during the construction process. It is important to be informed of construction activities long before they take place. If known far enough in advance, several techniques can be used (e.g. growth regulators, moving trees, fertilization, etc.) to help the trees survive the construction process. There should be a clear line of communication between landscape maintenance personnel and the personnel supervising the construction activities.

To avoid future utility conflicts, limit trees and plantings at least 10 feet from utility lines (above and below ground) if possible.

To maintain the highest level of safety, Texas A&M's pre-construction policy requires that an advance utility locate be performed for 1) Any ground penetration on campus, to any depth, when mechanized equipment such as augers, trenches, excavators, etc. will be used and 2) All ground penetrations to a depth greater than 12 inches. Any excavation to a depth less than 12 inches without a utility locate is required to be done via hand-digging or soft excavation. Excavation in the vicinity of underground utilities must be done with care and if necessary by hand. All projects must follow Texas A&M's Utility Locate Procedure which is outlined by Utilities and Energy Services. More information can be found at <https://utilities.tamu.edu/>.



Site Furniture and Features along Military Walk



Pocket Park at SUP 3

Softscape

Trees and Plantings

Approaching the campus holistically, the base planting should be expressed across the campus, while simultaneously using the distinct conditions present in Character Zone to accent and diversify the campus. College Station's challenging soils and water conditions require that the campus' environmental needs be carefully considered when selecting plantings and detailing how they are planted.

Campus plantings should be Texas native or adaptive species that will succeed in the Post Oak Savannah and Blackland Prairie ecoregions. As defined by the US Department of Agriculture, native plants live and grow naturally in a particular region or ecosystem without direct or indirect human intervention. Adaptive, or "naturalized," plants were introduced long ago but are able to reproduce and thrive without human intervention. These baseline definitions help align plantings with the environment or ecoregion in which they will be planted, ensuring greater softscape success across campus.

The plant list included at the close of this chapter includes trees (shade/medium/ornamental), evergreen shrubs, ornamental grasses, grass-like plants, screening plants, naturalized/biofiltration plants, ground covers, annuals (for color), perennials and other shrubs, vines, and turf grasses that are recommended as suitable Texas native and adaptive species.

The plant list is broken down into 75% and 25% categories. The broader campus landscape structure should come from the 75% plant list, ensuring visual continuity as well as improving the strength and longevity of the landscape through plant material that is best suited for the challenging campus environment. The 25% plant list is for small gathering areas, or "special spaces," where unique areas with site specific softscape and hardscape materials bring diversity to the campus outdoor experience. These plants may need additional maintenance or micro-climate zones where they can be featured as specialty plantings.

Campus Tree Care: The University has recently completed a Campus Tree Care Plan. The purpose of the plan is to identify and establish regulated policies and procedures committed to proper planting, maintaining, protection, conservation, and removal of trees on campus, that are universally understood and practiced by developers, contractors, faculty, staff, and students. These policies and procedures will contribute to enhanced aesthetics, environmental awareness, safety, sustainability, image, and identity or "sense of place" that reflect the values of the Aggie spirit. This plan is a comprehensive guide to trees on the campus, and should be used as a resource in parallel with the Campus Master Plan.

Tree Removal, Replacement and Relocation: One of the issues facing the campus landscape is the decline, and in some cases death, of historic oak trees. As historic trees are lost to natural and environmental causes, such as drought, age, poor growing conditions, and possible fungal diseases like oak wilt, campus needs to have a clear replacement plan. While a lack of vegetative diversity and mono cultural plantings are generally discouraged, there are some locations on campus where it is appropriate. Military Walk is composed of a strong line of historic live oaks that have created beautifully shaded roads and sidewalks. It is appropriate to replace a dying/dead live oak with a new live oak. Outside of such iconic campus spaces, a diverse mix of trees is otherwise suggested. Newly created malls, such as along Evans Library, should include a diverse mix of shade or ornamental trees, while maintaining regularity and pattern so as to avoid random and discordant plantings. In some cases, it will be necessary to remove a large healthy tree, especially when it is located within the building footprint of planned/upcoming construction. When these unavoidable conditions arise, tree relocation is encouraged and should be thoroughly considered before a final decision to remove a tree is made.



Shade Tree located at Residence Hall



Live Oaks at Glasscock Building



Shade Trees located at Evans Library Mall

Trees in Construction Areas: Texas A&M holds construction projects to standard tree preservation and protection rules so as to minimize tree damage commonly attributed to soil compaction, root damage, and branch or trunk wounding. Existing trees and natural areas shown on the plan to be preserved shall be protected by fencing before construction begins and fencing shall be maintained throughout all phases of the construction project. No equipment or materials shall be stored or operated within the fenced areas. Fences shall be at a minimum the drip line and completely surround the tree or clusters of trees. Fences shall be 6' high chain-link. Fencing may not be moved without the approval of the Campus Arborist. Where any of the above exceptions result in a fence being closer than 4 feet to a tree trunk, protect the trunk with strapped-on planking to a height of 8 feet (or to the limits of lower branching) in addition to the reduced fencing provided. No burning of debris, cleaning fluids, concrete spills, etc. will be allowed within fenced areas. Any roots exposed by construction activity shall be pruned flush with the soil. Backfill root areas with good quality top soil as soon as possible. If exposed root areas are not backfilled within 2 days, cover them with organic material in a manner which reduces soil temperature and minimizes water loss due to evaporation. Trenching shall not occur within the fenced drip line areas of existing trees.

Where construction will occur within a tree protection barrier, a tree protection plan shall be developed during the planning phase of the project by a Board Certified Master Arborist or a Registered Consulting Arborist with documented local experience with tree preservation. The tree protection plan shall include an evaluation of impacts on the trees from proposed development and construction, identification and the location of trees to be removed and/or preserved, tree protection zones, tree protection barriers, soil erosion controls, staging and storage areas, both existing and proposed utilities, and other on-site activities that may impact the condition of the trees. An arborist shall monitor the trees on site weekly and report issues to responsible parties.

Tree Grates: Whenever possible, trees should have limited paving around them. However, in more urban areas of campus where space is tighter, tree grates are a way to increase area around trees without compromising their health. Cast iron or permeable paver grates are both acceptable. In both cases, grates must be removable to accommodate incremental tree growth and expansion. Tree grates should be a minimum of 6' x 6' and come no closer to the trunk than 6". While tree grates offer expanded area and improved tree protection, they do require regular maintenance to remove cast iron rings or pavers as trees grow and expand. As such, they are not maintenance free and need to be included in a regular maintenance plan. Tree grates are typically used in tandem with interconnected tree wells.

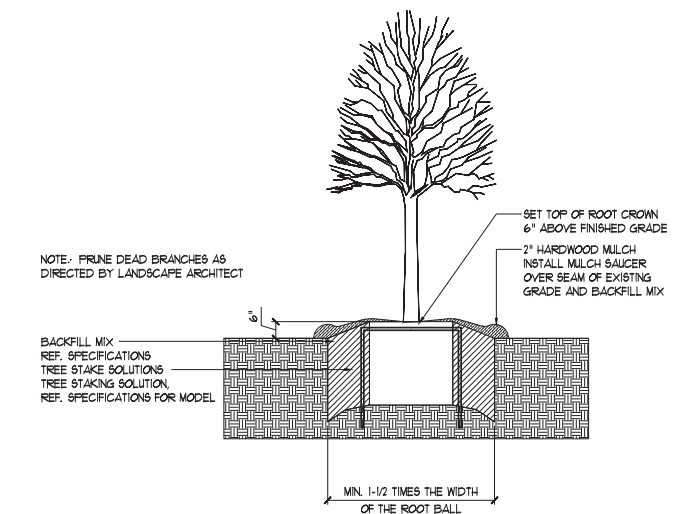

Construction Detail: Tree Grate



Century Tree located in Academic Plaza

Tree Staking: The Texas A&M system incorporates a below-ground tree stabilizing system for all shade and ornamental trees. Placing staking below grade eliminates tripping hazards for pedestrians and obstacles for maintenance equipment. Below-ground systems do not require hoses, clamps, wires, or twine to stabilize trees and are easily removed and reused once a tree takes root, although it is not necessary to remove them. Below-ground systems are low maintenance, promote trunk growth, and make fertilizing and deep root watering easier.

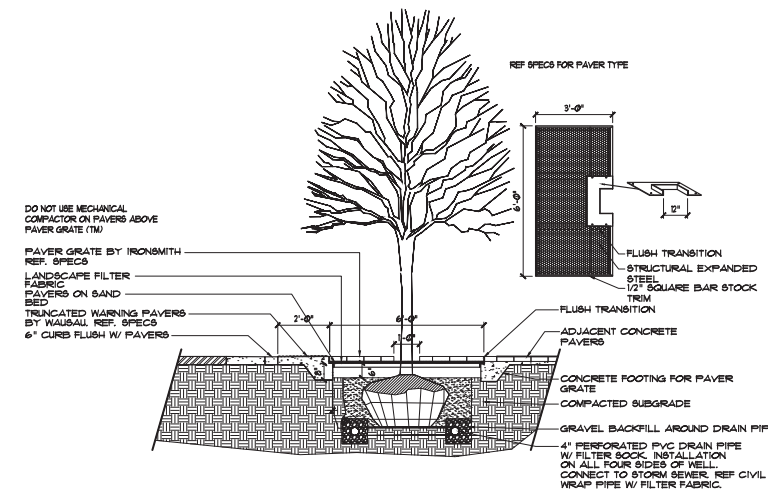

Construction Detail: Tree Stake

Interconnected Tree Wells: Shade trees offer numerous advantages to urban and campus environments, such as aesthetic beauty, on-site water management, and reduction of the heat-island effect. Unfortunately, shade trees are typically planted in small volume areas with highly-compacted, low-quality soil. Considering a typical shade tree needs roughly 1,200 cubic feet of soil to reach optimal growth, these are undesirable conditions that greatly impact their health and longevity. Interconnected tree wells (such as the brand Silva Cell) help create larger areas and networks through modular suspended pavement systems where roots can optimally expand and grow. The modular design is ideal for almost any application but is particularly popular in hardscape dense, pedestrian-heavy areas, such as campus malls and quads. These proven systems enable the optimal growth and longevity of shade trees and should be considered for new tree plantings on Texas A&M's campus.



Detail: Interconnected Tree Well

Soils, Drainage & Planting

Texas A&M's campus straddles the Post Oak Savannah and Blackland Prairie ecoregions where the native top soil was historically about 12 inches deep and generally rich in decomposed organic material. Today, Texas A&M's native top soil layer is either non-existent or extremely compromised campus-wide, and the existing soil consists of a shallow topsoil layer and a dense clay pan underneath. This soil structure, coupled with an irrigation supply that relies on well water with elevated quantities of mineral salts, results in hampered growing conditions for most plant material. Plants struggling to survive in soils with poor permeability and drainage can experience toxicity, inadequate amounts of moisture and oxygen, and a high pH making essential nutrients unavailable to them. To help counter these challenging growing conditions, planting native and adaptive vegetation that is better able to handle soil salinity, while regularly amending the soil by adding organic material, fertilizer, and additional topsoil, is recommended. Prior to planting, soil testing should be performed to determine the soil's composition and what, if any, chemical amendments might be necessary.

Improving campus soil greatly increases the overall health of the softscape and also plays a significant role in reducing stormwater runoff, which is a significant problem on campus. Drainage issues on campus include flooding buildings, puddling on pedestrian paths, swamped open spaces, and negative impacts on White Creek, such as extensive downstream erosion. There are very few low-impact design solutions for storm water employed on campus, which causes large amounts of water to run directly into storm outlets that drain downstream. This is exasperated by the expansive amounts of impervious hardscape on campus. Most of the older courtyards and quadrangles on campus have been designed to remove storm water off site into the storm sewer system as quickly as possible, limiting infiltration and groundwater recharge in these areas.

Due to the poor drainage on campus, Texas A&M prefers to plant their trees higher in the landscape. In general the top of any tree's root ball shall stand after settlement of the backfill approximately 20-30 percent above finish grade. As such, trees should be placed in the ground so that the root flare is 6" above the finished grade. Shrubs require a minimum of 14"-16" soil planting depth. Ground covers require a minimum of 12" soil planting depth. Four to six inches of top soil is required for sod. (See Construction Details)

To improve the softscape's resiliency and ease its maintenance requirements, it is important to incorporate proper spacing when planting. Overplanting in tight spaces makes it difficult for the maintenance staff to ensure the design integrity, as well as the plants' health. Crowded plants compete for resources, such as light and water, and are also more susceptible to disease. Placing plants too close to walkways encourages growth to spill over bed edges onto paths, becoming an impediment and nuisance for pedestrians and maintenance vehicles.

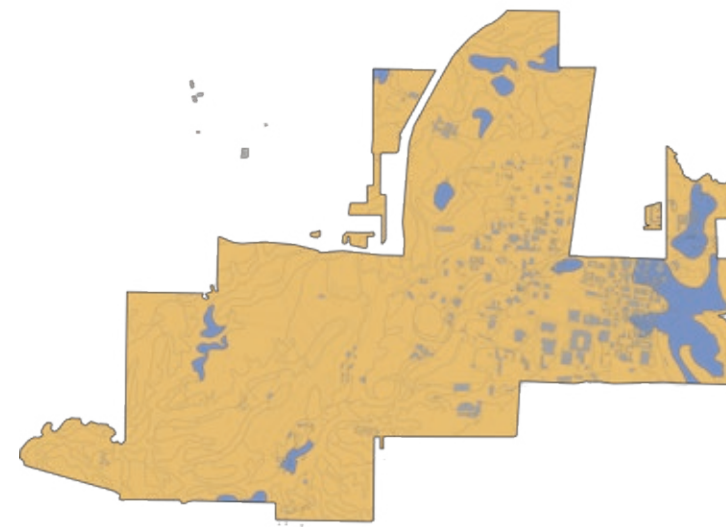

Campus Soils Plan based on ecoregions, 2004 Campus Master Plan

Mulch

Mulching vegetation is a vital part of industry-wide best practices for newly planted materials, as well as for ongoing plant maintenance programs. A two to three inch deep organic mulch ring should be applied no closer than one inch from the trunk. The mulch ring's ultimate width may vary and instructions should be included in the design set details. There should be no exposed dirt after mulch application. Mulching needs to be replenished annually.

Tray Systems

Roof gardens are an increasingly popular typology, and there are several installations at Texas A&M. Tray systems can be used, but it is necessary to consider how these applications will be watered when specifying them. Whether pre-grown or plant-in-place trays are specified both will be most successful if they are watered with rain water or condensate. Overhead irrigation, with its high salt content, may not support all vegetation. Roof gardens can be both popular green spaces and living lab zones, as long as their growing needs are recognized and incorporated into the design and an appropriate maintenance program is implemented.

Water Collection

Campus has twelve underground cisterns, none of which are currently in use. Above ground options, such as cisterns, rain barrels, and condensate, are gaining in popularity as viable and efficient means of collecting water and should be explored as alternative ways to irrigate campus' softscape. These options can be much easier to maintain and require fewer infrastructures to preserve their functional integrity. Additionally, the water from these collection methods will be salt-free, thus better irrigation sources for campus vegetation. Texas A&M should create standards within the Facility Design Guidelines for above ground and below ground campus rainwater and condensate collecting.



Student and Faculty Green Roof Project at the Langford Architecture Building

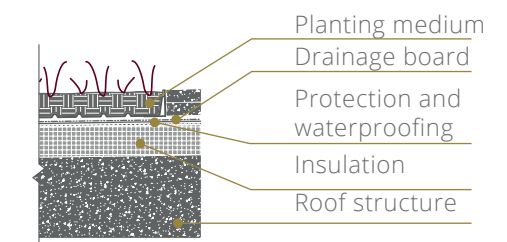

Extensive

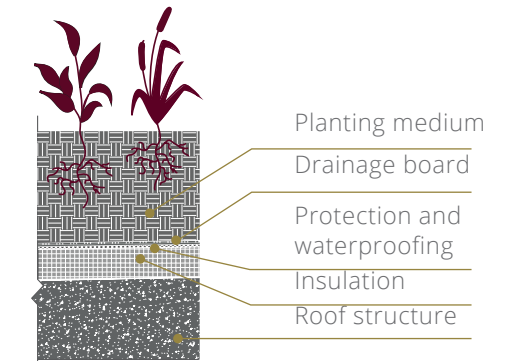

Intensive

Green roofs can be intensive or extensive depending on soil depth.



Rainwater Collection Cistern at Agriculture Building

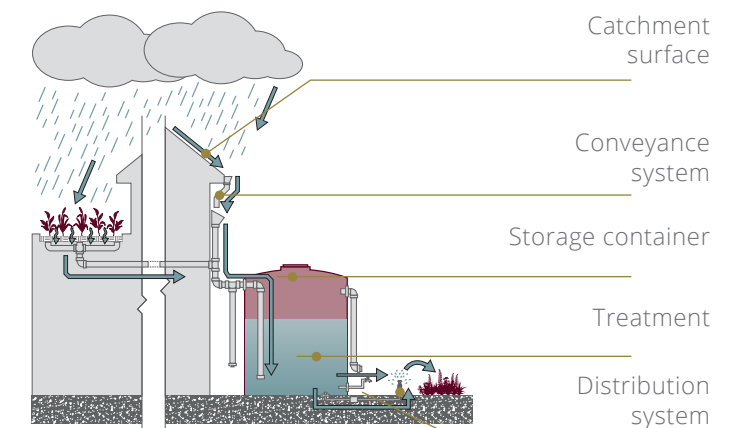

Rainwater Harvesting



Hardscape

The continuity of ground level materials plays a major role in the structure of the broader campus environment. When differing elements are adjacent, it can be particularly confusing and undermines the desire for order and ground plane structure. A palette that upholds the designated campus standards for items such as paving helps strengthen visual order on the campus, allowing campus users to easily recognize boundaries, transitions, and programs for any campus space, small or large.

Paving

Pavers are encouraged in pedestrian-heavy areas, such as civic spaces, quads, pocket parks, courtyards, and entries. They are also successful in both connector and mall applications .

Currently, the campus features pavers within important spaces on the campus - both heritage spaces such as Military Walk, and new outdoor spaces such as the Corps of Cadets Quad, Memorial Student Center and the Liberal Arts and Arts and Humanities Building. Overall, the campus currently is displaying a plethora of hardscapes that differ in material, color, style, patterning and construction, highlighting both a lack of cohesion and a hierarchy of spaces.

Moving ahead, Open Spaces on campus should consist of a cohesive palette of materials using designated/approved patterns and colors that support the intent to tie the campus together. The following considerations should be made when selecting pavers:

- All paving must contextually relate to the Character Zone, precinct in which it is located. Selection of pavers should not be specific to the adjacent building(s), but instead the immediate larger context.
- At Campus edges, Character Zone edges, and Heritage Open Spaces, it may be necessary to blur and/or merge paving types to achieve visual balance and conformity.

- Where a smaller-scale sidewalk, path or open space meets a larger-scale public space, standard paver color, size, and patterns must be used.
- More intimate applications, such as private or insulated courtyards, can allow for limited variety in colors, sizes, and patterns.
- With the rich character of existing spaces on the campus, it is vital to allow for variation where appropriate. The material types should be from the same color family but can vary slightly within developed character zones or precincts that have a established palate that differs from the campus at large. For example, Athletics and Recreation has distinct hardscaping around Kyle Field to denote an area for gathering, but the color palate is similar to the hardscaping adjacent to this area. Thoughtful material choices illustrate and support campus cohesion, while still allowing for distinct and unique spaces.



Corps of Cadets Quad



Corps of Cadet Center Plaza



Fire Lane Paving

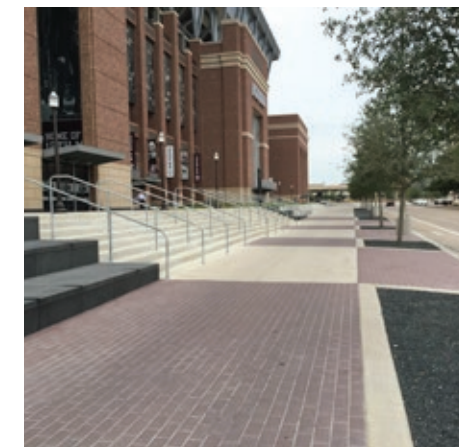

Existing Paving at Kyle Field

Materials and Construction: Paving on campus can include concrete or clay pavers, concrete panels accentuated with paving bands or paving “buttons,” or just concrete. All hardscapes on Texas A&M’s campus must be designed to meet or exceed American Disabilities Act and Texas Accessibility Standards.

Pavers can be concrete, clay, or other paving material, such as limestone or granite, as long as the surface is textured to provide a slip resistant finish. Pavers must be installed over a reinforced concrete sub base (minimum 4” with #3 rebar) and use polymeric sand. The paver depth and the concrete/ reinforcing design must be sized to accommodate the type of traffic that will be using the surface (pedestrian, vehicular, or fire truck). All pavers should be supported by reinforced concrete contained and at the edge with a minimum 12” concrete band to avoid failure. Drainage over and around all paver installations shall be designed to avoid ponding or retention of water within the paver field. To further facilitate water flow from the pavers, installed weeps may also be necessary. Paver cuts should be avoided or minimized. Ideally, the design modular for paver fields should be designed to accommodate a full paver pattern. When pavers must be cut, no paver “remnant” less than 1/3 of a paver should be used. Infill pavers will concrete or mortar instead of paver slivers.

Colored or stylized concrete, with the exception of access ramps, is not to be used. Concrete must be reinforced with appropriately spaced and sized reinforcing bars. Appropriate concrete finishes include broom finish, exposed aggregate, as long as the surface provides a slip resistant finish, or patterned concrete, as long as the patterns does not create a trip hazard or maintenance issue and is not stamped.

Colors: There is a wide variety of paver colors present on campus. Projects in which new pavers will be installed should attempt to specify pavers that adhere to the existing palate of maroons, reds, browns, greys, and natural stones (cream, buff or tan in color) and also relate to the existing surrounding context. All paving must contextually relate to the character zone in which it is located and cannot be specific to adjacent buildings. Colored concrete is not to be used.

Patterns: Acceptable paving patterns include 45 degree herringbone, 90 degree herringbone, stretcher bond, basketweave. Similar may be proposed. Busy patterns should be avoided.

Final approval for any hardscape material, patterning, design and location shall be made by the Council for the Built Environment and the Office of the University Architect.

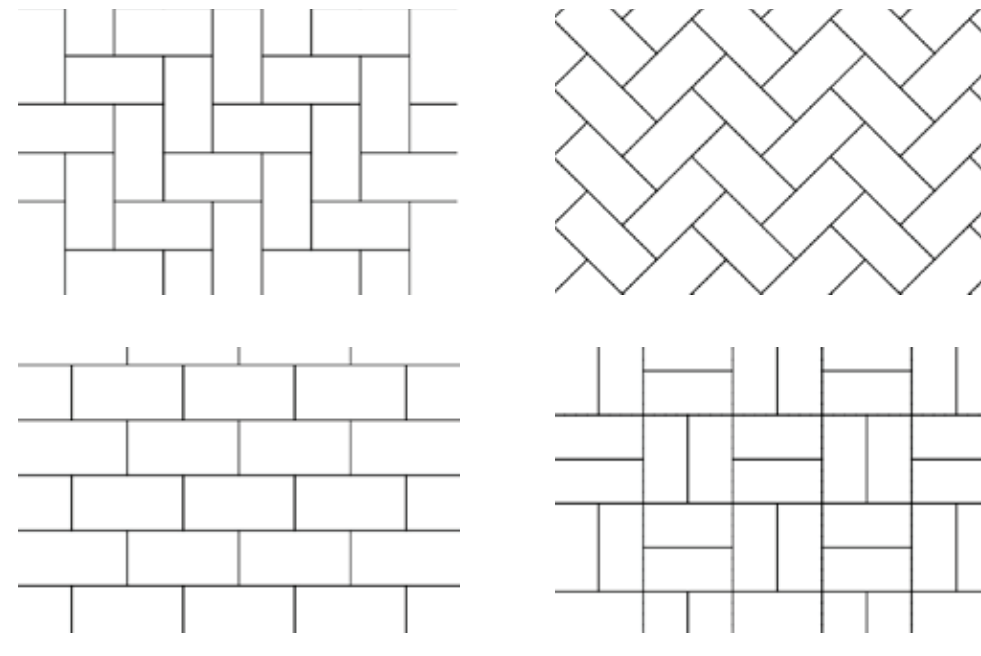

Acceptable Paving Patterns: From Top Left to Bottom Right - Herringbone, 45 degree Herringbone, Stretcher or Basketweave.

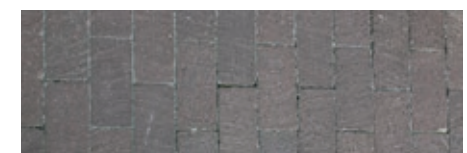

Pavers can be concrete, clay, limestone or granite. Colors are to match surrounding context within above color family.

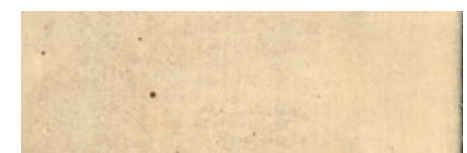

Concrete

Artificial Turf

Artificial turf is not allowed when natural Turfgrass is feasible for the intended location or use. Artificial turf is allowed with constraint in site specific situations where natural Turfgrass will not thrive or when artificial turf is used as an outdoor amenity such as for a volleyball court, horseshoes/washers, or other specialized applications, such as the Engineering Activities Building Courtyard berms. Where ever artificial turf is installed, a hose bib (water source) for cooling and cleaning should be located within 100 feet of every portion of artificial turf. Drainage and the proper stabilizing subsurface shall be installed as per manufacturer's specifications.



Artificial Turf at Engineering Activities Building

Access Ramps

Access ramps at sidewalks shall use truncated dome pavers, manufactured of fired clay or concrete material. Ramps with scored, integral-colored concrete shall be reinforced concrete. All truncated dome pavers must be designed with a reinforced concrete subbase and mortar bed. All ramps on campus must be designed, located, and installed in accordance with the American Disabilities Act and Texas Accessibility Standards.

Handrails

Ramp and stair handrails should be aluminum, galvanized steel, or stainless steel. Painted handrails are not appropriate, due to their high upkeep. Handrails used in key areas on campus could be lit, such as at Memorial Student Center. All handrails on campus must be designed, located, and installed in accordance with the American Disabilities Act and Texas Accessibility Standards.

Fire Lanes

Proper emergency vehicle access throughout campus is essential. Emergency lanes are typically concrete or concrete pavers. To lessen their visual impact, lanes can be gravel pave, grass pave, or pavers, but they must be able to carry an emergency vehicle load. Emergency lanes must be a minimum of 20' wide and located 15 - 30' away from a building's edge for ladder access. The minimum obstructed height of a fire lane is 14', and any vegetation hanging in the fire lane must be trimmed up to 14'. All fire lanes must be appropriately marked on the curbs and curb ends. If a fire lane is required but no continuous curb exists then mounted signage or alternate painting is required. All building projects should be reviewed by the local fire department and fire lane markings/signage must be approved by the Fire Marshall.

Gravel

Gravel is a popular alternative for turf or paved areas and plant-based mulch. It can also be used as a maintenance band around structures or in un-planted areas, such as under stairwells. Due to its permeable nature, gravel can be a good material choice in areas where increased storm-water management methods are incorporated. Increased airflow and water infiltration through the material benefits trees. While gravel does have low-maintenance properties, it is not completely maintenance free and must be secured in place by containing it with a border or edge. Because gravel can migrate it will need to be replenished periodically as well.

Gravels as Walking/Gathering Surfaces – Gravels as hardscape (patios, paths, and gathering spaces) shall be installed to minimize migration of material. This can be accomplished through inclusions of “fines” in the material, stabilizers, and/or compaction. With the exception of park or athletic uses, gravel areas should be used with restraint and are not allowed for high-intensity use spaces where the only access or gathering is exclusively gravel. Concrete edging must be installed along all paths and patios unless other approvals are granted. Drainage should be provided so that erosion of materials or ponding does not occur during rain events. ADA accessibility must be considered when designing these spaces.

Gravels in Lieu of Plant-Based Mulch – Gravel in planting beds (except maintenance bands) should be used with great constraint. Only plants that perform well in gravel beds should be allowed, such as yuccas, native grasses, or other xeric plants. Gravel shall not contain any “fines” and shall be thoroughly washed when placed. Gravel should be constrained by curb, concrete edging or other physical constraint to prevent migration of material.

Gravel as Maintenance Bands – Maintenance bands are defined as a zone of approximately 2 - 5 feet around a structure that separates the structure (slab) from planting and irrigation areas. This zone not only keeps irrigations (both drip and spray) away from walls and glass, but serves additionally as access for maintenance operations. Gravel in these zones can be inexpensive “washed river gravel” or equivalent. It is not always necessary to provide a weed barrier or physical separation (steel edging or concrete band) unless this zone is highly visible. (See Guidelines Chart for gravel sizes)



Site Furniture

Standard site furnishings, which include benches, tables, chairs, and bicycle racks, should be an integral part of the development of campus streets, open spaces, and pedestrian zones for a consistent campus character. However, campus areas of cultural or historical significance may have unique site furnishings specific to the character of those spaces. As site furnishings need to be replaced in areas with existing styles, new site furnishing must match what is already present. As older site furnishings fail or need to be replaced in areas that do not have existing styles, they should be upgraded with the brands and styles called out in the Campus Site Furnishings and Hardscape Standards document. Site furnishing choices should be approved by the Council for the Built Environment and/or the Office of the Architect. Placement of all site furnishings should never obstruct pedestrian or emergency vehicular traffic and should allow for adequate circulation and access for wheel chairs, per Texas Accessibility Standard. Construction should be of commercial grade for low maintenance, ease of cleanup, vandal resistance, and weather resistance. Depending on material type, site furnishings need to be anchored to pavement or use in-ground installation. Regular maintenance is required to keep all site furnishings free of chips and cracks, fading, and peeling paint/coatings.



Site or Garden Walls

Site or garden walls can be used for grade accommodation, screening purposes, or seating areas. These walls encourage informal meeting and gathering places in locations that naturally attract people, such as building entries or transit hubs. These walls should be permanent structures that match the campus standard. Site or garden walls should be brick or stone with a pre-cast stone cap or concrete where appropriate. The brick and stone should match the brick types in the building materials per character zone. A concrete finish may be utilized where appropriate and must be approved by the Council for the Built Environment and/or the Office of the University Architect. The preferred height for site or garden walls should be sixteen to twenty inches. Site and gardens walls should have a consistent top elevation and step down with the grade where necessary, instead of sloping with the grade. To protect the site or garden wall structure and ensure their availability for those wishing to sit, skateboard deterrents should be included along the walls.



Proposed Site/Seat Walls
From Top Left to Bottom Right: Blue Bell Stadium, Memorial Student Union, Liberal Arts and Humanities, Oceanography and Meteorology Building, White Creek Apartments, Engineering Activities Building

Bollards

Bollards are necessary to control entrance to pedestrian-only areas and to protect equipment and buildings when in close proximity to vehicular traffic.

Bollards may be fixed or removable but must adhere to Texas A&M Campus standards. These standards can be found in the Utilities and Energy Services' Exterior Lighting and Installation document. More information can be found at utilities.tamu.edu. Some bollards may have to be removable to allow for emergency access into the core of campus. Bollards may be lit.

Exterior Lighting

Exterior lighting is critical for maintaining a high-level of safety across campus during the evening hours, as well as for making sure programmed outdoor spaces, such as athletic fields, are usable after dark, while respecting established Texas A&M aesthetics and addressing economic concerns of maintenance and operation of the campus outdoor lighting system.

Texas A&M's standards, as outlined in the Utilities & Energy Services' Exterior Lighting and Installation Document, include fixtures, poles, lamps, and lighting control for these specifically defined areas on campus:

- Pedestrian/General Area Lighting (Primary Campus Standard)
- Historical Pedestrian and Heritage Area Lighting (Standard for Noted Historic District Lighting areas, including New Main Roadway and Military Walk)
- Parking and Roadway Lighting

All fixtures must be a "white light" (no High Pressure Sodium) and be "dark-sky" compliant as required by state law. It is important to make sure that lights and trees are properly placed and not in such close proximity that the tree canopy interferes with lighting. To minimize light obstruction, it is recommended to plant trees no closer than 11' of light poles.



Standard Bollards



Standard Exterior Lighting



Any deviation from the campus standards must be approved by Utilities & Energy Services, the Council for the Built Environment and the Office of the University Architect. Manufacturer specifications for fixture and poles are available in the Exterior Lighting and Installation Document. More information can be found at utilities.tamu.edu.

Structured Shade

In addition to planting new shade trees, which can take years of growth before they provide adequate shade, the campus can install built-in shading structures to provide immediate shade in both large and small gathering areas. There are three examples of possible shade structures that currently populate campus:

Architectural: Any shade structure on campus should relate to the adjacent building vernacular. Traditional versions of shade structures that relate to the historic buildings on campus are appropriate within the historic core. More contemporary styled shade structures, such as the metal arbor in Hullabaloo's Courtyard, are appropriate for newer buildings or outdoor spaces on campus. Architectural structures are also appropriate for bike parking shelters.

Bus Shelters: Bus shelters are important for providing students and other campus visitors waiting for the bus suitable protection from the elements. A well-designed bus shelter can also enhance the traveling experience and solidify the sense of place. Wherever possible, transit hubs should provide shade and seating.

Campus bus shelters should be durable and economical and be easily installed on site. The overall design should include adequate protection from the elements and ease and safety of use, as well as appropriate integration into the overall campus aesthetic so as to minimize visual impediments to adjacent campus buildings. Currently, there are two bus shelter styles on campus:

- 10' x 20' Hip Roof Shelter – located at Wehner Building and South Area Residential Hall
- 10' x 10' Hip Roof Shelter – located at Wisenbacker Engineer Research Center and South Area Residence Halls

Texas A&M's suggested manufacturer and model number can be found in the Campus Site Furnishing and Hardscape Standards, which also includes material, size, clearance and color specifications for both shelter sizes.

All campus shelter designs, which includes bike and golf cart shelters, such as the ones at J.K. Williams Administration Building, must be well proportioned to give them a sleek and elegant appearance, similar to the campus standards for bus shelters. All components and elements of the shelter should read as part of a consistent design language and items such as signage, seating, lighting, and trash receptacles should constitute an integrated, cohesive, and consistent design. In addition to the standard bus shelters, additional treatments that integrate into the campus landscape should be explored for larger queuing areas or transit hubs. For example, the bus queue along Houston Street attracts hundreds of students waiting for their scheduled bus. The waiting experience could be greatly improved with large shade structures that incorporate seating and help clarify and direct movement through a regularly crowded part of campus.

Tensile Canvas: Canvas shade structures are located on campus within the green spaces adjacent to the Engineering Activities Buildings (EAB) and within residence life areas. These contemporary forms of shading are not appropriate for the historic core but may be appropriate elsewhere across campus, such as for hammock areas, around student housing, or in parks. In some cases, such as at EAB, the intent is to ultimately eliminate the canvas shade structures once the surrounding trees have reached maturity and are providing ample natural shade.



Proposed Shade Techniques
 From Top Left to Bottom Right:
 Hullabaloo Shade Structures, Golf
 Cart Parking area at J.K. Williams
 Administration Building, Bus Shelters
 at Houston Street (Beutal Hall), Tensile
 Shade Structure at Engineering
 Activities Buildings, Proposed Houston
 Street Transit Hub Improvements

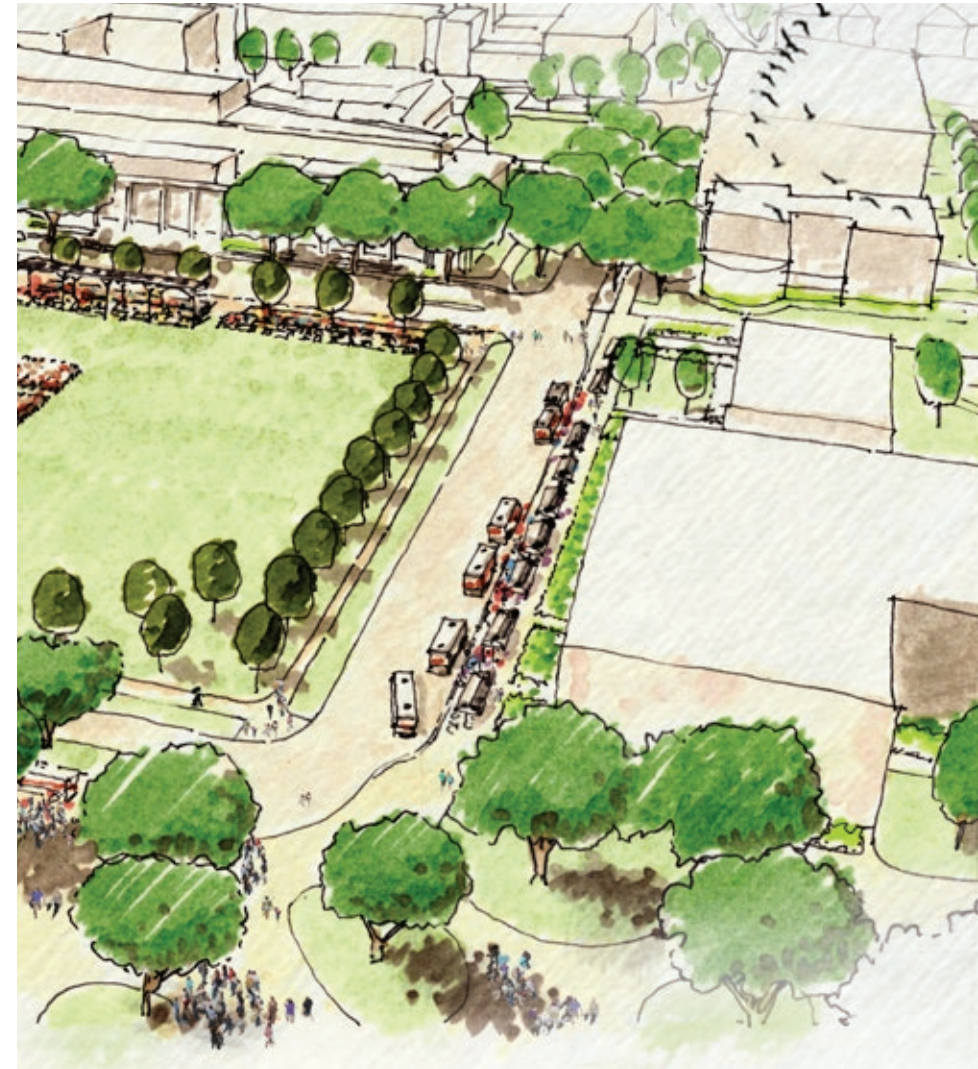

Houston Street Transit Hub

- Since Live Oaks have been removed, addition of bus shelters along Houston Street from Lamar Street to Old Main Drive
- Shelters should not impede on pedestrian circulation or queuing areas.
- Improved landscaping, including site walls and benches for additional seating, resilient plantings for stormwater management, exterior lighting, and paving.

Bike Parking

As Texas A&M works towards a stronger pedestrian-centric campus that encourages alternative modes of transportation, accommodating bicyclists and bicycles becomes a bigger priority. Purposefully incorporating bike parking into the campus design, improving usability, proximity, and safety, and making sure that bike parking is either sheltered or screened depending on its location is necessary. To ensure safety and visibility after dark, all bike parking areas must be well lit. Bike shelters should provide adequate protection from the elements for both bicyclists and bicycles and should follow the design guidelines recommended for shelters. (See Structured Shade above)

When providing screened bike parking, Texas A&M has three approved methods:

- Low brick wall with stone cap
- Brick wall with sections of metal screen
- Softscape hedge - double planting row consisting of a row of grasses with a row of shrubs. Planting bed must be a minimum of 8' deep to accommodate edge (concrete mow strip) and plantings.



Proposed Bicycle Parking Standards
From Top Left to Bottom Right: Brick wall with Stone Cap, Covered Bicycle Parking, Landscape Screen



Proposed Texas A&M Campus Condition

Service and Mechanical Screening

Wherever possible, service and mechanical screening should be integrated into the building design. If it is not possible to incorporate the screening into the building, service and mechanical spaces shall be screened with brick enclosures, softscape, or metal fencing/screening, such as a louvered metal fence system. Metal screening shall comply with campus standards in relation to material, type and color if it is not designed as a unique application. Brick or stone enclosures should be contextually appropriate to the adjacent building. Softscape screening can include landscape buffers, such as green walls or planted berms, but must provide full screening upon completion of project. Screening should keep service areas out of sight, while providing proper ventilation for the equipment.



Mechanical and Service Screening
From Top Left to Bottom Right:
Perforated Metal Screen at Liberal Arts and Arts & Humanities Building, Vegetative Screen, Brick wall with Stone Cap, Perforated Metal Screen at Liberal Arts and Arts & Humanities Building

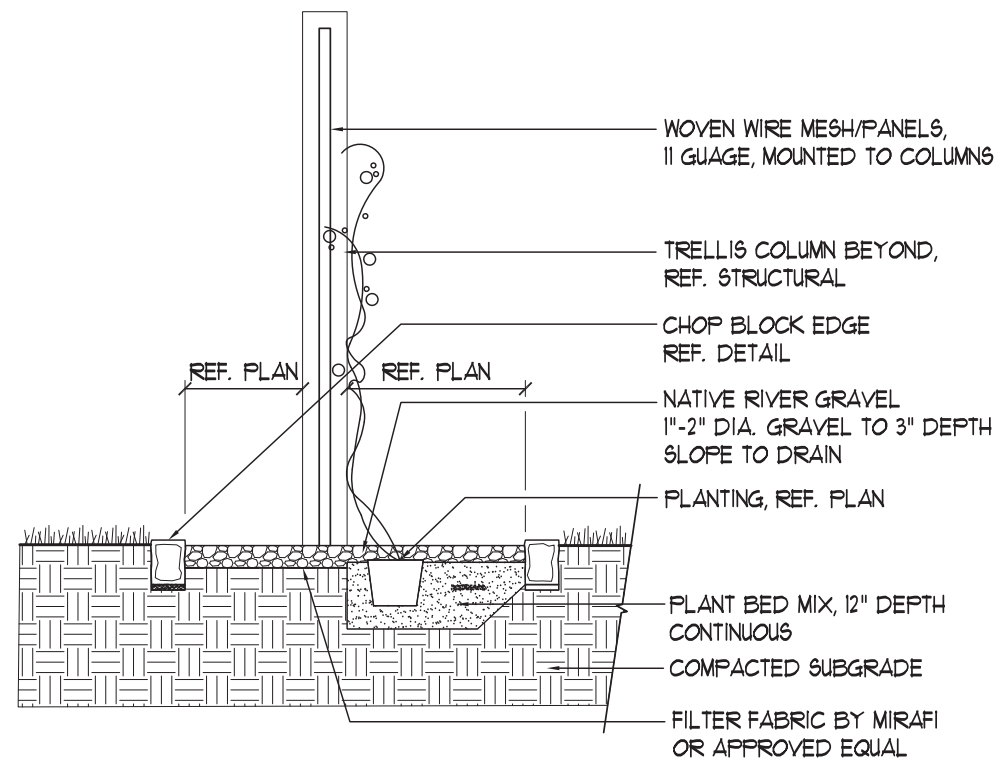

Construction Detail: Trellis Location



Grills

There are a number of areas on campus for outdoor grilling, specifically in close proximity to residence halls and park areas. Where outdoor grilling is permitted (Residence Halls, Parking Lots with RV access, Recreation Outdoor Activity Area (Backyard), etc.), coal bins for safe disposal of used ashes must also be present. BBQs and coal bins must be made of heavy gauge steel with high-temp, non-toxic powder coated or enamel black paint.

Trash/Recycling Receptacles

So that all open spaces remain clean and free of debris, trash/recycling receptacles should be placed accordingly and should comply with Texas A&M Campus standards. They should be level and firmly secured to the ground to avoid easy removal by theft. Additionally, they should have drainage openings at their base, be fire-proof, vermin-proof (crows and other animals), and vandal-proof, and hold a 40-50 gallon container. Trash receptacle placement should be appropriate to encourage/facilitate use with the trash container closest to the area highest in traffic. Ash urns or trash receptacles with an ash tray must be located at least 20 feet away from doors. All containers shall be located on an accessible path of travel per the ADA and State Building Code. Locations and placement must first be approved by the Department of Physical Plant and the Texas A&M Recycling Center. The University is currently in the process of updating its standard recycling receptacle. This new standard will be for both interior and exterior locations



Existing BBQ at Hullabaloo Hall



Texas A&M Trash and Recycling Receptacle Standard

Emergency Telephones

Security, or “blue light,” phones are an important element in the overall campus safety strategy. Blue light phones can be used to contact campus security for any reason, such as to call for an escort, to report a suspicious person, or report an emergency so that security, police, fire, or medical personnel can be contacted and directed to a specific location. There are 115 blue light phones located across Texas A&M’s campus. These phones are distinguished by a 12-foot pole with a blue light on top and “Police Help” written on the front and sides. The weatherproof box includes a red button that when pressed directly connects to the University Police Dispatcher.

Security phones must be strategically located throughout campus with clear site lines so that they are visible. Each location shall be ADA accessible. Free standing pole foundations shall include one 1” telephone conduit, one 1” power conduit, and anchor bolts. Texas A&M’s suggested manufacturer and model/style number can be found in the Campus Site Furnishing and Hardscape Standards.

Hammock Stands

The sight of students lounging in hammocks around campus is become more popular. These efforts to take time out of the day and connect with nature and each other have caused questions about where these hammock communities should be located on campus and if the trees that are being used should be substituted with dedicated hammock stands instead. Some campuses have successfully created dedicated hammock “nests,” constructed with cemented in steel posts and eye bolts. The eye bolts serve as a place for students to clip their hammocks, as well as a place to hang their personal belongings. As Texas A&M’s student population grows and hammocks gain in popularity, campus should consider dedicated zones, infrastructure, and even shade sails for hammocks.



Texas A&M Emergency Phone Standard

People Movers





People movers are open spaces that facilitate movement throughout campus via a network of paths, sidewalks, connective spaces, and roadways. With the goal of creating a large pedestrian zone that enhances the pedestrian experience on campus, these linkages are important elements within the broader campus landscape. In some cases, these linkages act as transition areas, bringing the open spaces on campus together to create a seamless experience. All people movers need to be understood as complete elements and designed to include paving materials, site furnishings, and plantings.

People movers need to be sized so that they accommodate existing and projected pedestrian traffic. The paving and surrounding plant material choices must reflect the amount of traffic expected in any specific area. Malls, connectors, and the urban edge should be barrier-free. This includes avoiding steps in these areas as much as possible. Ramps and other grade transitions need to be incorporated as seamlessly as possible. In addition to the primary program and goal of getting people through spaces, people movers should also include areas where the public can rest and interact.

People movers are a series of paths, sidewalks, malls, and other connective spaces that facilitate movement across campus, helping to create a seamless, conflict-free pedestrian experience, while eliminating confusion with clear orientation and circulation. An established paving hierarchy for these campus linkages supports to maintain appropriate scales and highlights places importance. The following hierarchy applies materials, colors, patterns specific to the type of connection. The corresponding diagrams and guidelines should be used as a baseline, but are not the only acceptable solutions. Final approval for any hardscape material, patterning, design and location shall be made by the Council for the Built Environment and the Office of the University Architect.

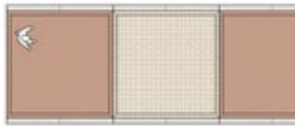
Visitors to campus take a guided tour ►

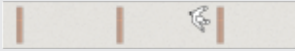
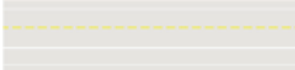

People Mover	Size	Locations	Materials (see page XX for detailed information)	Site Furnishings	Plantings
Limited Access Street 	Dimensions vary based on existing right-of-way; must be able to accommodate service and emergency vehicles	Internal campus roadways within Pedestrian-Priority Zone	Pavers with 12" – 24" concrete banding with either an entirely paver span or an incorporated every other concrete panel; Must be able to accommodate service and emergency vehicles	Path and Pole Lighting; Seating Areas throughout; Bollards may be necessary;	Canopy trees; Given the larger amounts of pervious area in malls, alternative storm water techniques should be explored, such as retention areas with bioswales or rain gardens.
Pedestrian Mall 	Typically 12'-20'; dimensions may vary based on existing conditions	Internal to campus; Along major axis of the campus framework schema	Pavers with 12" – 24" concrete banding with either an entirely paver span or an incorporated every other concrete panel; Must be able to accommodate service and emergency vehicles	Path and Pole Lighting; Seating Areas throughout; Bollards may be necessary	Canopy trees; Given the larger amounts of pervious area in malls, alternative storm water techniques should be explored, such as retention areas with bioswales or rain gardens.
Major Connector 	Dimensions may vary based on existing conditions	Along major roadways; adjacent to premier buildings	Pavers with 12" – 24" concrete banding with either an entirely paver span or an incorporated every other concrete panel; Must be able to accommodate service and emergency vehicles	Path and Pole Lighting	Canopy trees; Given the larger amounts of pervious area in malls, alternative storm water techniques should be explored, such as retention areas with bioswales or rain gardens.
Large Connector 	Typically 8'-12'	Connections between quads, courtyards, malls, etc.	Concrete with bands of pavers along the edge and perpendicular; concrete with large bands of pavers only perpendicular; or similar	Path and Pole Lighting	Canopy trees; Given the larger amounts of pervious area in malls, alternative storm water techniques should be explored, such as retention areas with bioswales or rain gardens.
Small Connector 	Typically 4'-8'	Connections between quads, courtyards, malls, etc. Adjacent to roadways	Emphasized sidewalks should be concrete with bands of pavers (1 or 2) only perpendicular; Basic sidewalks to be plain concrete; or similar	Path and Pole Lighting	Canopy trees; Given the larger amounts of pervious area in malls, alternative storm water techniques should be explored, such as retention areas with bioswales or rain gardens.
Multi-Use Path 	Typically 10'-14' with 2' shoulders; Delineate pedestrian and bicycle/skate lanes	Adjacent to roadways; within open park-like spaces	Concrete or similar; must be suitable for pedestrians, wheelchairs, cyclists, and skaters.	Path and Pole Lighting; Seating Areas throughout; Bollards may be necessary	Canopy trees; Given the larger amounts of pervious area in malls, alternative storm water techniques should be explored, such as retention areas with bioswales or rain gardens.
Urban Edge 	Typically 8'-14'; sidewalks should be able to accommodate large groups of people; 40'-50' set backs	University Drive (Texas Ave to Wellborn Road), Raymond Stotzer Parkway at Vet Med Complex, George Bush Drive at Recreation Complex	Emphasized sidewalks should be concrete with bands of pavers (1 or 2) only perpendicular; Basic sidewalks to be plain concrete; or similar	Path and Pole Lighting	Canopy trees; Shrubs and accent planting planted in large masses and placed between the road and the sidewalk to discourage unsafe roadway crossing
Boulevard	Preferred Multi-Use Paths adjacent to roadway; If right-of-way does not allow, Small connectors (4'-8') should be present on either side of roadway		Concrete or similar; must be suitable for pedestrians, wheelchairs, cyclists, and skaters.	Path and Pole Lighting	Canopy trees; Shrubs and accent planting planted in large masses and placed between the road and the sidewalk to discourage unsafe roadway crossing

Malls

Malls are used as a public walk or promenade through campus and are predominantly populated by groups of pedestrians, bicyclists, and skateboarders. Military Walk and the underpass at Wellborn Road are considered successful examples of campus malls.

Location: Malls should be internal to campus and within the Pedestrian-Priority Zone. The Framework Schema can dictate where new pedestrian malls should be located as campus development occurs.

Size: Malls are typically 12' – 20' but can be larger based on existing conditions, such as in the case of the conversion of roadways to limited access roadways such as Spence Street, Nagle Street and Lamar Street. Where applicable, malls must be sized large enough for service and emergency vehicles to access.

Materials: Pedestrian Malls are typically dominated by hardscape. Streets converted into limited access streets or pedestrian malls shall be fully paved. (Figure 1); or similar. Internal campus malls shall be pavers with 12" – 24" concrete banding with either an entirely paver span or an incorporated every other concrete panel (Figure 2-3); or similar.

Site Furnishings: Purposefully placed benches and small seating areas adjacent to malls are appropriate and path and pole lighting is essential, allowing people to walk safely after dark. (See pages X-X for acceptable site furnishings)

Plantings: Shade trees should align along both sides of the mall to provide formality, as well as shade and comfort. Trees can be consistently spaced but do not have to formally line the sidewalk. Shrubs and accent plantings directly adjacent to paths should be avoided so as not to create vegetative barriers. Given the larger amounts of pervious area in malls, alternative storm water techniques should be explored adjacent to malls, such as retention areas with bioswales or rain gardens.

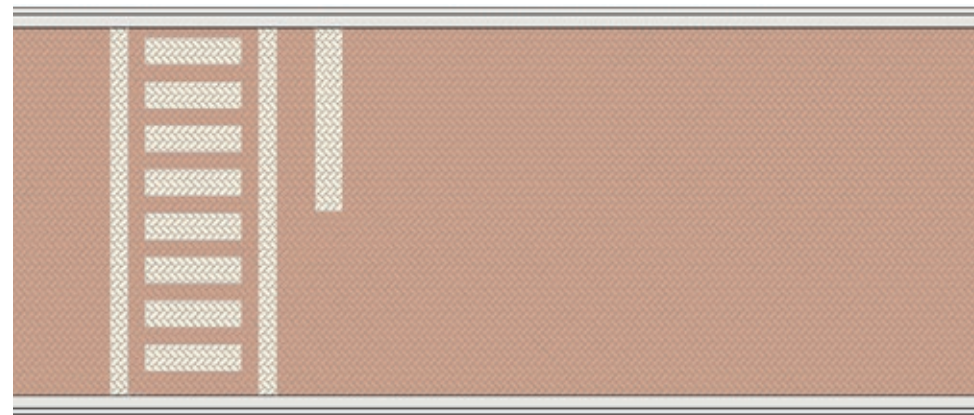

Figure 1: Limited Access Street



Intersection condition



Paved Crosswalk in contrasting paver color



Concrete banding and curb



Transition from Limited Access Roadway to unlimited roadway



Underpass at Old Main Drive and Wellborn Road



Military Walk

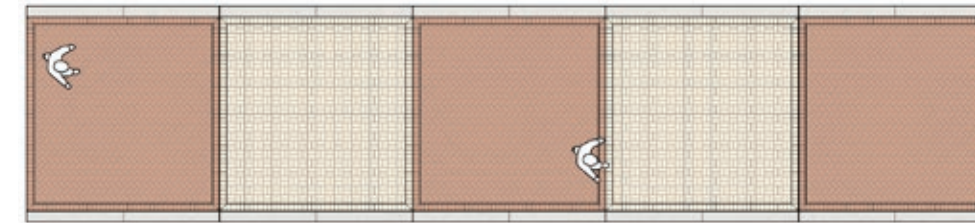

Figure 2: Pedestrian Malls (12'-20')

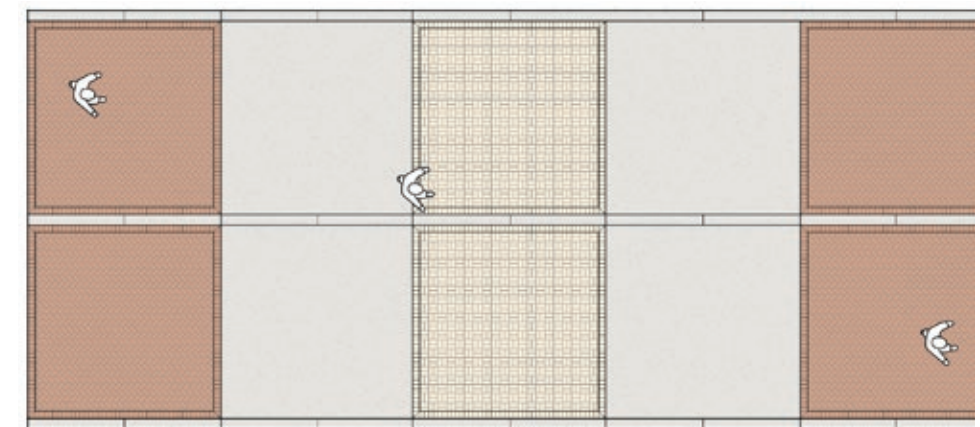
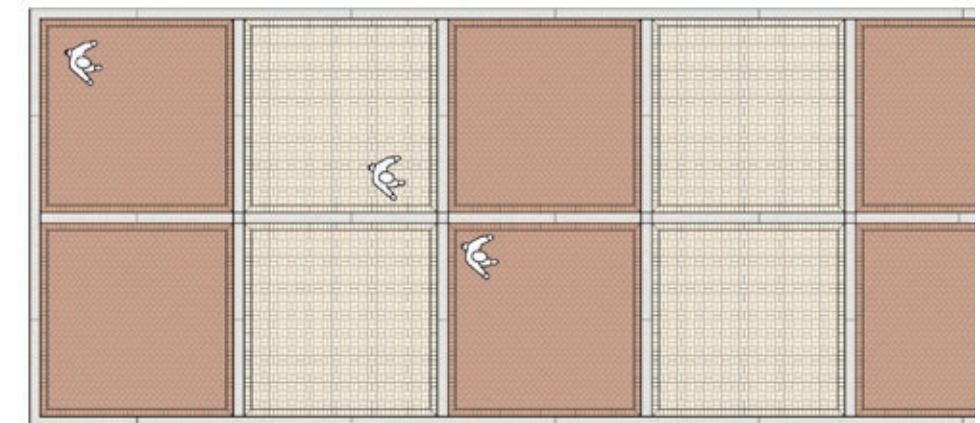
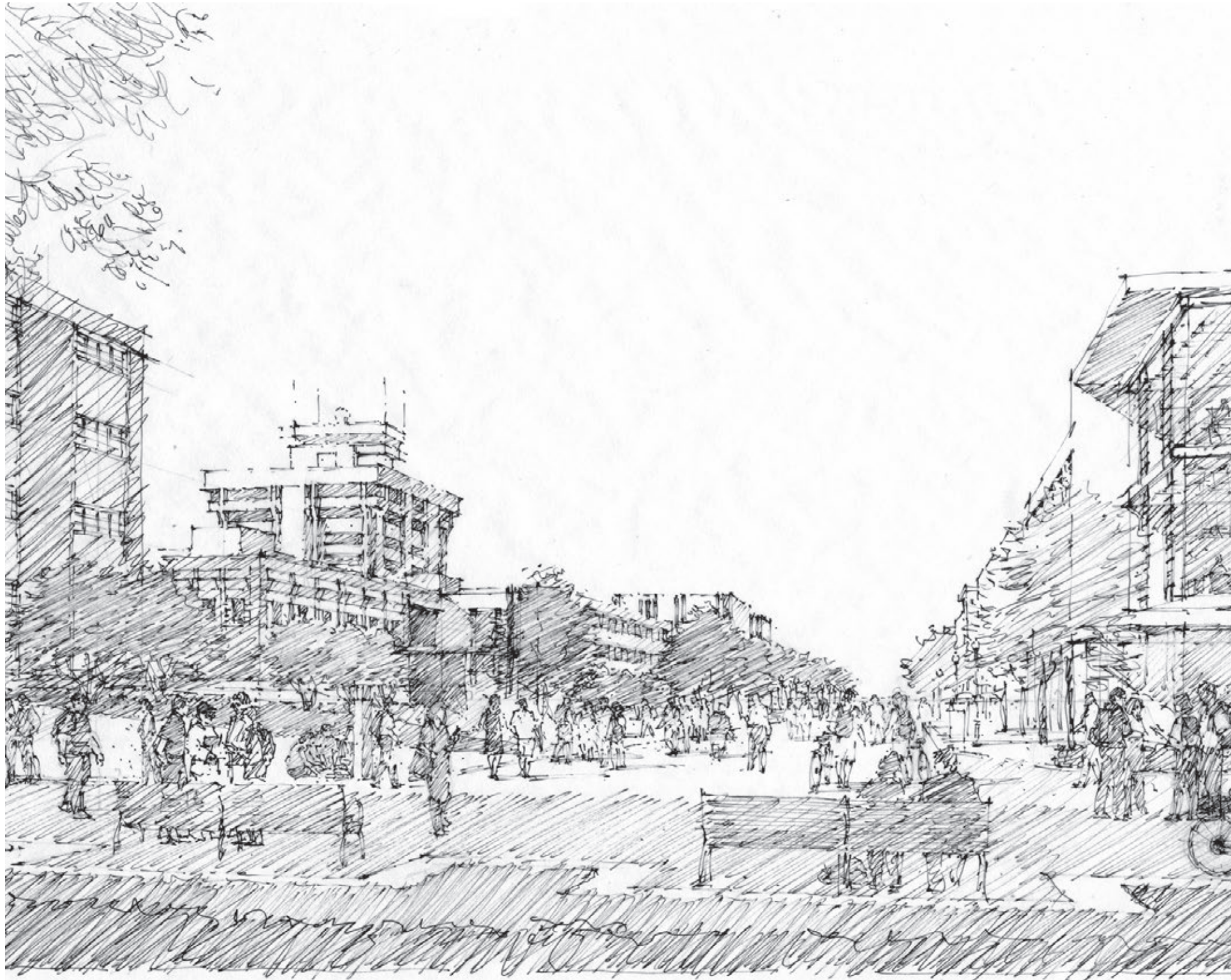

Figure 3: Pedestrian Malls (20' wide or more)



Lamar Street

- As Research Park is built out, a series of connectors, malls, quadrangles, courtyards will develop in between new and existing buildings
- Hardscaping should consist of standard exposed aggregate, concrete pavers and brick pavers
- Canopy trees are recommended for providing shade and organization



Evans Library Malls

- As Research Park is built out, a series of connectors, malls, quadrangles, courtyards will develop in between new and existing buildings
- Hardscaping should consist of standard exposed aggregate, concrete pavers and brick pavers
- Canopy trees are recommended for providing shade and organization

Connectors

Connectors are the interstitial linkages between buildings, quads, courtyards, malls, and along roadways. These spaces are meant to be multi-functional, sized to allow for large groups of pedestrians, bicyclists (outside of dismount zone), and in some cases service and emergency vehicles.

Connectors should be sized and designed based on their location. This results in three types of connectors:

Main Connector: Existing examples include along Houston Street at Kyle Field and along Joe Rott Boulevard at the Memorial Student Center

Large Connector: Existing examples include the connection from the corner of Coke and Lubbock Streets into the Corps of Cadets area

Small Connector: Existing examples include sidewalks along the Urdan edge of the campus along University Drive

Location:

Major Connectors: Located along roadways or adjacent to premier buildings.

Large Connectors: Located as connections between malls, quads, courtyards, etc.

Small Connectors: Located as connections between malls, large connectors, quads, courtyards, and adjacent to roadways.

Size:

Major Connectors: Dimensions vary based on existing conditions.

Large Connectors: Typically 8'-12' wide (*Where applicable, connectors must be sized large enough for service and emergency vehicles to access.*)

Small Connectors: Typically 4'-8' wide

Materials:

Major Connectors: Pavers with 12" – 24" concrete banding with either an entirely paver span or an incorporated every other concrete panel; or similar (See page XX for hardscape guidelines).

Large Connectors: Concrete with bands of pavers along the edge and perpendicular; concrete with large bands of pavers only perpendicular; or similar

Small Connectors: Emphasized sidewalks should be concrete with bands of pavers (1 or 2) only perpendicular; Basic sidewalks to be plain concrete; or similar

Site Furnishings: Due to their multifunctional nature, connectors are not best suited for long-term seating opportunities. Seating can be spaced at greater distances along the connectors. Since these spaces are often heavily used by pedestrians crossing campus, it is imperative that they be safely lit and well-maintained. Connectors that pass through historic places on campus will require appropriate lighting to match the historical aesthetic of the space.

Plantings: Canopy trees are recommended for providing shade and comfort. Trees can be consistently spaced but do not have to formally line the sidewalk. Shrubs and accent plantings directly adjacent to paths should be avoided so as not to create vegetative barriers.



Major Connector



Large Connector



Small Connector



Figure 3: Major Connector (dimensions vary)



Figure 4: Large Connectors (8'-12')

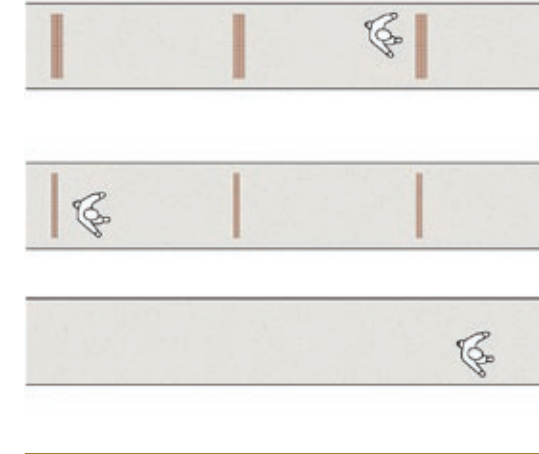

Figure 5: Small Connectors (4'-8), Urban Edge



West Campus Walk

- Located, sized and designed as a Large Connector
- Multi-functional, sized for large groups of pedestrians, bicyclists, and service and emergency vehicles
- As west campus grows, a series of connectors will develop in between new and existing buildings to connect outdoor spaces
- Canopy trees to provide shade and comfort
- Integrated fire and safety access

Multi-Use Paths and Trails

Multi-use paths and trails are increasingly a part of campus infrastructure as administrations seek to improve students' quality of life and incorporate greater recreation and alternative transportation opportunities. Multi-use trails, or shared-use paths, are an excellent way to efficiently connect different parts of campus, while providing dedicated spans for regular walking, skating, and bicycling. Horticulture Street is a recently completely example of a multi-use trail on campus.

Location: Adjacent to roadways and within open park-like spaces

Size: National design guidelines require that two-directional multi-use trails be a minimum of 10' wide with 2' shoulders. For more heavily-used trails, suggested widths are 12' – 14' with 2' shoulders. Separation from motor vehicle traffic via an open space or barrier is an aesthetic, as well as safety, feature of multi-use paths.

Materials: When choosing paving for multi-use trails, multiple forms of transportation must be considered. Paths should be traversable and accessible for bikes, pedestrians, wheelchairs, and skaters. Paving or striping should delineate pedestrian and bicyclist zones. Trails must be built to accommodate users with disabilities.

Site Furnishings: Seating along multi-use trails should be located occasionally to offer areas of rest. They should not be an impediment to safety and must be located far enough off the path to be outside the zone of travel. Multi-use trails are used for transportation and leisure throughout the day and evening and require adequate lighting to ensure usability and safety after dark.

Plantings: Canopy trees are recommended for providing shade and comfort. Trees can be consistently spaced but do not have to formally line the sidewalk. Shrubs and accent plantings directly adjacent to paths should be avoided so as not to create vegetative barriers. Plantings along multi-use trails should be complimentary to any adjacent open space.

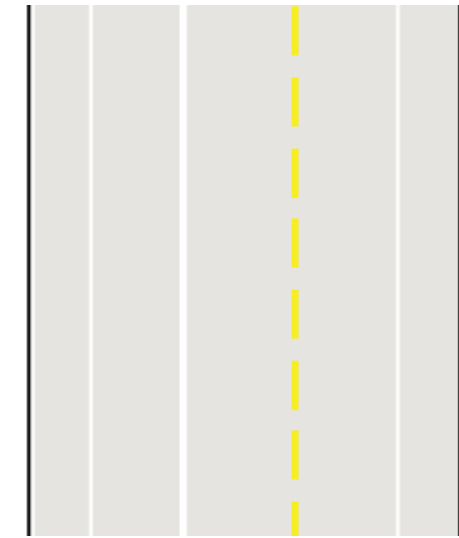

Multiuse Path



White Creek Detention Area

White Creek Detention Area

- Detention basins are being developed within the White Creek area to improve stormwater run-off from the campus
- Multi-use paths and trails adjacent to overfill areas
- Naturally re-tree and lost trees due to detention basin additions
- Exterior lighting should be placed throughout to address user safety



Proposed Multi-use path at Olsen Boulevard

Olsen Boulevard Multi-use Path

- To better accommodate pedestrians and cyclists a separated 16' multi-use paths are to be added along both sides of Olsen Boulevard from University Drive to Kimbrough Boulevard
- Paving should delineate pedestrian and bicyclist zones
- Exterior lighting should be placed throughout to address user safety
- Regularly spaced street tree planting along the edges with ornamental trees and shrub plantings in the median.

Urban Edge

Urban edges are usually heavily populated zones where people transition between the edges town and campus. The urban edges of campus create the “town-gown” relationship between Texas A&M and the City of College Station. The goal of the current, phased roadway improvement project between the City of College Station and TXDOT is to transform University Drive into a lively, pedestrian-oriented area that connects campus users to off-campus housing and local businesses. The project’s improvements are streamlining traffic flow and controlling pedestrian crossings. Additionally, sidewalks along University Drive are being repaired and widened wherever possible, allowing for pedestrians and bicyclists to stay clear of the roadway. Removing the existing brick walls along the north side of University Drive and adding large mass plantings and regularly spaced shade trees will also greatly improve the aesthetic quality of the “town-gown” edge. As the campus and surrounding neighborhoods are developing, more urban edges have emerged, such as the along Raymond Stotzer Parkway between western campus and the Vet Med Complex, and along George Bush Drive at the new Recreation Complex. Overtime, more urban conditions may emerge as development occurs both on and off campus.

Location: Urban edge conditions should be located at heavy pedestrian areas and areas where many campus users travel between on and off campus. The existing urban edges of the campus are located at University Drive (from Texas Ave to Wellborn Road), Raymond Stotzer Parkway at Vet Med Complex, George Bush Drive at the Recreation Complex.

Size: Typically 8'-14'; Sidewalks should be able to accommodate large groups of people. Building set backs from the street should be 40'-50'

Materials: To better define the edges of campus, concrete sidewalks should be emphasized with bands of pavers. See page XX for hardscaping and paving guidelines and acceptable solutions.

Site Furnishings: These busy edge zones are not best suited for long-term seating opportunities; however, seating can improve the overall aesthetic quality. Seating along the urban edge should be located occasionally to offer areas of rest. Lighting: Standard pedestrian lightings along edges make these places safe for those going into town or returning to campus after dark.

Plantings: Canopy trees are recommended for providing shade and comfort. Trees can be consistently spaced but do not have to formally line the sidewalk. Softscaping (shrubs and accent plantings) is being incorporated to soften the building edge as well as to help control and discourage pedestrians from crossing at unsafe, un-designated areas along this busy roadway.

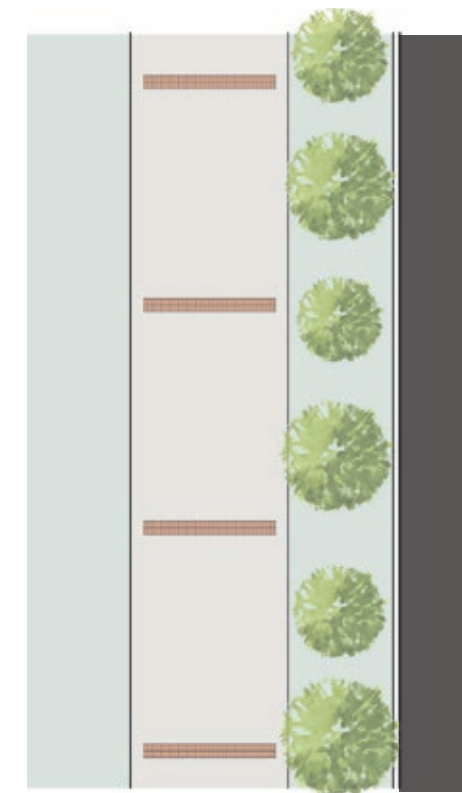

Urban Edge



Proposed Solution: Spence Street (planned to become a pedestrian mall) at University Drive

Spence Street at University Drive

- A new pedestrian entrance into campus - closed to private vehicles (specifically during busy daytime hours)
- Multifunctional, sized for large groups of pedestrians, bicyclists, and service and emergency vehicles
- New buildings along University Drive should be 50' from street edge to accommodate a multi-use path and vegetative buffers

Boulevard

Boulevards should be designed as complete systems that simultaneously and effectively accommodate cars, buses, bikes, and pedestrians. In most cases, boulevards will have multiple traffic lanes and adjacent multi-use paths to accommodate pedestrians and bicyclists. In order to provide a high level of safety to pedestrians, traffic measures such as crosswalks, speedbumps, signage, and lighting should be consistent. White Creek Boulevard is considered a successful example of a boulevard.

Size: If no multi-use path is located adjacent to the boulevard, generous sidewalks (4'-8') should tie logically into the overall pedestrian framework of the campus.

Materials: Paving along boulevards will depend on the location and the context but will be predominantly asphalt for the roads or heavy duty concrete at bus stops.

Site Furnishings: Heavily-trafficked areas are not appropriate for encouraging pedestrian seating. Standard campus lighting is necessary along heavily trafficked areas to ensure the safety of the motorists, pedestrians, and bicyclists who share the roadways.

Plantings: Boulevards should be tree-lined to provide shade and formality to the streets. Street trees should be consistent per block but varying species across campus are encouraged assuming a basic consistency in scale and form. Coordination between tree and utility locations must take place in order to ensure consistent tree spacing, while avoiding existing utility lines. Where ever possible, streetscapes should incorporate integrated storm water management best practices and employ low maintenance, high-resilience native plantings.



White Creek Boulevard



Proposed Road Section at Kimbrough Boulevard

Kimbrough Boulevard Improvements

- New shared-use path on both sides of road
- Improved median landscaping
- Separated pedestrian paths
- New raised vegetated buffers
- Travel lanes narrowed

Large Gathering

Large gathering areas are the non-continuous spaces where users are encouraged to assemble. These gathering spaces are a blend of larger, open spaces and interspersed smaller areas for single users or small groups. Bringing program to these large gathering spaces activates the landscape and encourages campus users to engage with spaces that are currently underutilized, such as the East Quad and In order to stimulate activity, large gathering areas should integrate various forms of seating, including movable tables and chairs, site or garden walls, and benches. Seating variety fosters social interaction and provides opportunities for rest and relaxation. Wherever appropriate, large gathering areas should be utilized for campus programs and events, recreation activities, and socialization.

Even though the primary use of these spaces is for gathering and interacting, there is also movement within and through these spaces. As such, pathways should follow and support intuitive movement flow. Large gathering areas are often at the intersections of malls or connectors, thus the language should remain consistent in order to support a seamless pedestrian experience and minimize confusion.

These areas should include a mixture of highly manicured lawns and native vegetation to aid in storm water management. Hardscaping should reflect the prominence of the spaces by featuring standard exposed aggregate and concrete/ brick pavers. Plain concrete should be avoided. Wherever possible, these areas should include plantings that provide softscaping interest, shade, and year-round usability.



Students take a break under the trees in the Academic Plaza ▶

Civic

Civic spaces contribute directly to Texas A&M's identity and are where people predominantly gather to celebrate, exchange, and mingle. Civic spaces are also considered the "public" areas of campus, as they attract not only students, faculty, and staff but also alumni, future students, and other campus visitors.

These areas are not typically used on a daily basis but are heavily utilized multiple times of the year by large amounts of people. As such, these areas must be designed for high durability and easy conveyance of people. Places of respite, such as benches, planter walls, and seating plinths, are necessary in these spaces and should occur frequently to accommodate the masses; however, circulation is the primary goal and seating areas should not hinder easy movement.

Civic spaces are often used after hours, so appropriate lighting is essential in how well these spaces perform and serve the public. Pole and path lighting should be used in conjunction to ensure the space is safe throughout the evening. Lastly, all materials used in and around civic spaces should be highly durable and low maintenance. This includes all hardscape, softscape, furniture, lighting, and signage components necessary to make these spaces successful.

J. K. Williams Administration Building East Lawn, and Simpson Drill Field are all examples of civic spaces.

A mixture of turf grass and hardscaping materials are generally predominant in civic spaces depending on the use of the space. Paver types and colors should relate to the surrounding context and also align with the guidelines for hardscaping. Busy patterns should be avoided. If large amounts of turf grass and paving are present, alternative storm water techniques should be explored like retention areas with bioswales or rain gardens.

Ample seating is necessary to accommodate the masses when large events happen in these spaces. Many different types of seating can be explored and incorporated into a creative design that ensures seating options do not hinder the ability to move large quantities of people through the space. The after-hours nature of civic spaces requires adequate lighting to ensure usability and safety throughout the evening.

Canopy trees are recommended for providing shade and comfort. Trees can be consistently spaced but do not have to formally line the sidewalk. Shrubs and accent plantings should be planted in large masses and considered a higher maintenance area due to their predominant location and visibility.



Simpson Drill Field Improvements

- Relocate drill field seating to northside of field
- New built-in seating, paving and shade structures to accommodate spectators
- Improve drainage issues to improve the utilization of the space
- Re-tree perimeter as necessary

Quadrangles

Campus quadrangles (quads) are created when multiple buildings come together, resulting in a space that's enclosed on three to four sides. Quads are predominantly used by people sitting, socializing, and studying, making them popular nodes of activity on campus. These areas are prime locations for multiple types of seating, movable and fixed options, colorful plants, shade trees, public art displays, and open lawns. Quads are activated, social zones where people tend to gather, linger, relax, and socialize. Adequate seating is necessary to ensure the continued success of campus quads. The after-hours nature of civic spaces requires adequate lighting to ensure usability and safety throughout the evening.

Given that quads are intersections where multiple malls or connectors come together, they must also accommodate large volumes of people at peak passage times. Properly designed circulation routes are critical to the long-term success of these spaces. Within the quadrangle, plaza space can be incorporated to allow people to gather for large, occasional events but also for daily relaxing and socialization. Plazas should include tree and vegetative plantings that provide shade and make the spaces pleasant and useable year round. Canopy trees are recommended for providing shade and comfort. Shrubs and accent plantings should be planted in large masses and considered a higher maintenance area due to their predominant location and visibility. Lighting should include pole lighting to ensure the safety and security of students who gather in and pass through these spaces after dark.

Hardscaping materials are generally the predominant element in quad structure. Paver types and colors should relate to the surrounding context and also align with the guidelines for hardscaping. Adding pattern can break up large overwhelming swaths of materials, while also creating visual interest. Busy patterns should be avoided. If large paving are present, alternative storm water techniques should be explored like retention areas with bioswales or rain gardens.



Open Space Improvements: Cushing Quad, Evans Malls, Nagle and Lamar Streets



Open Space Improvements: West Campus Quadrangle

West Campus Quadrangle Improvements

- Improved organization – from informal and circuitous to formal and symmetrical
- Integrated fire and safety access
- New pavilion building centrally located to shorten the visual perception between eastern and western campus
- Shade trees and human scaled landscaping reduces the scale of the large open space



Open Space Improvements: Cushing Quadrangle

Cushing Quadrangle Improvements

- New intuitive connections and circulation placed diagonally within quadrangle
- Integrated fire and safety access
- Central gathering area and smaller gathering areas within
- New Monarch butterfly garden
- Deciduous trees in core with Evergreen shade trees along perimeter
- Connect to Evans Library Malls, Nagle Street and Lamar Street through consistent paving, landscape and site features



Existing Conditions: Cushing
Quadrangle

Small Gathering

Small gathering areas, or “special spaces,” are outdoor areas of campus that are more “interior” in nature, often visually and/or physically detached from the broader campus landscape. They encourage collecting and gathering at more intimate scales and are frequently unique spaces that pleasantly “surprise” the user when they come upon them. These spaces are ideal for extra creativity and should be viewed as canvases for one-of-a-kind designs. Due to their distinctive nature and more site specific expanded materials palette, they may vary from the campus standards and will need to be reviewed and approved by the Council for the Built Environment and the Office of the University Architect on a case-by-case method.

Small gathering spaces tend to be located on the edges of malls and connectors, immediately outside buildings, and sometimes within a building. Specifying program for these smaller campus spaces strengthens activation of the broader landscape and encourages campus users to engage with spaces that are currently underutilized. They may also include an educational element, as in the case of roof gardens.

Unlike large gathering areas, small gathering areas do not have vast amounts of movement and circulation within them. As such, small gathering areas should integrate various forms of seating, including movable tables and chairs, site or garden walls, and benches. A range of seating variety fosters social interaction and provides opportunities for rest and meditation. These areas are particularly well suited to featuring a “looser” mix of small lawn panels, native vegetation, and accent plantings. Custom furnishings, custom pavers or pavement types, artificial turf, decking, shade sails, shade structures, water features, and planters are all features that could be incorporated, enhancing the unique, or “special,” nature of these spaces.

Rudder Plaza and Fountain ▶



Pocket Park

Pocket parks are small in scale and passive in nature. Typified by seating and shade, they are great areas for studying, conversing, and reading. Plantings should be lush. Shade should be provided via trees or a built structure. These areas can be found within, or adjacent to, quads and courtyards but more typically will be the interstitial spaces on campus that are adjacent to buildings and malls. Pocket parks are excellent spaces to incorporate seating for those who wish to rest, study, or have quiet conversations. Movable seating allows for small groups to gather. More ambient lighting choices, such as wall lights, step lights, and bollards, are appropriate for pocket parks, but lighting must ensure safety for use after dark.

Canopy trees are recommended for providing shade and comfort. Ornamental trees are excellent choices for these smaller more intimate spaces. Shrubs and accent plantings should be lush and can include native vegetation and accent plantings. Small lawn panels can be incorporated in sunny spots and also provide areas for event gatherings. Pavings should match the size of the overall space, so as not to dwarf or overwhelm the pocket park with hardscaping materials. Paver types and colors should relate to the surrounding context and also align with the guidelines for hardscaping. Adding pattern can break up large overwhelming swaths of materials, while also creating visual interest. Busy patterns should be avoided. If large paving are present, alternative storm water techniques should be explored like retention areas with bioswales or rain gardens.



Existing Pocket Park at SUP 3



Existing Pocket Park at Chemistry Plaza

Courtyard/Entry

Courtyards are similar to quadrangles but are smaller in scale and typically enclosed on all four sides by a single building. These spaces fulfill a similar function of quadrangles but accommodate less people and do not need to circulate them in the same way. The program and subsequent design of courtyards should align with the program of the adjacent building. For example, courtyards adjacent to student housing should have gathering and study areas, hammocks, shade structures, outdoor seating, and open green space for small recreation activities. Courtyards adjacent to academic buildings should have areas suitable for individual and small group studying and should be more formal in their design.

Since courtyards are typically accommodating small gatherings, they should include benches and moveable tables and chairs. They should also have a balance of hardscape and softscape areas. Courtyards are excellent spaces to incorporate seating for those who wish to rest, study, or have quiet conversations. Movable seating allows for small groups to gather. Seating located at entries should be of materials that match or compliment the adjacent building. Lighting should be included to ensure the safety and security of students who gather in these spaces after dark. Due to their enclosed nature and smaller scale, lighting must be sized appropriately. More ambient lighting choices, such as wall lights, step lights, and bollards, are appropriate for courtyards, but lighting must ensure safety for use after dark. Entry lighting must be adequate to ensure visible and safe building entry/exit after dark.

Pavings should match the size of the overall space, so as not to dwarf or overwhelm the pocket park with hardscaping materials. Paver types and colors should relate to the surrounding context and also align with the guidelines for hardscaping. Adding pattern can break up large overwhelming swaths of materials, while also creating visual interest. Busy patterns should be avoided. If large paving are present, alternative storm water techniques should be explored like retention areas with bioswales or rain gardens.

Low-maintenance plantings are important for courtyard spaces, as limited access to courtyards will dictate the amount of feasible care. Canopy trees are recommended for providing shade and comfort as long as they do not outgrow their space and conflict with the architecture. Ornamental trees are excellent choices for these smaller more intimate spaces. Shrubs and accent plantings should be planted in large masses and considered a higher maintenance area due to their predominant location and visibility. Small lawn panels can be incorporated in sunny spots and also provide areas for event gatherings.

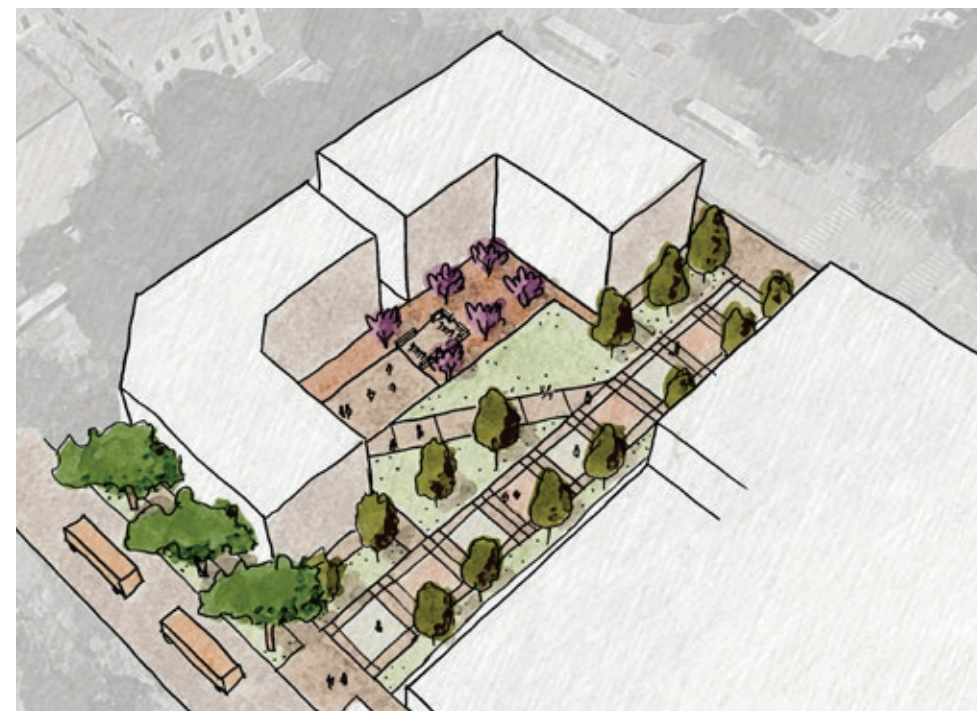

Proposed Courtyard at Military Sciences Building

Military Sciences Building Courtyard

- Remove surface parking lot
- New connection from Lubbock Street to Rudder Tower
- Improved Landscaping including ornamental trees, shrubs, accent plantings and lawn panels
- Include seating within to foster socialization and interaction
- Screened bike parking area

Roof Gardens

There are several roof garden installations at Texas A&M, and the hope is to expand this typology across campus and have it included in the design of all new buildings. As stated in Chapter Five, the environmental benefits of roof gardens, or “green roofs,” are tremendous. Their reduction in the urban heat-island effect, mitigation of storm water runoff, and help with lowering building heating and cooling costs makes them viable design solutions. They also provide ecosystems benefits to biodiversity and wildlife. Roof gardens provide a canvas for designers to be innovative and showcase creative design skills and state-of-the-art products. These areas can be marketed as an amenity space for buildings and can showcase sustainable design, while also being popular social spaces. These spaces can also enhance the concept of campus as a living lab through their inherently educational nature.

Roof top gardens are excellent spaces to incorporate seating for those who work or attend classes in the building to rest, study, or have quiet conversations. Movable seating, tables and, shade structures allows for small groups to gather. Seating located at entries should be of materials that match or compliment the building. Site or garden walls can also be used to create additional seating areas. More ambient lighting choices, such as wall lights, step lights, and bollards, are appropriate for roof gardens. Lighting must ensure safety for use after dark, and entry lighting must be adequate to ensure visible and safe building entry/exit after dark, unless the garden is not accessible after hours. Whenever possible the lighting should be located in the architecture or integrated with other elements like site or garden walls.

The garden component is especially important, and ensuring that there is a regular water source and adequate soil mass to sustain healthy, viable plant material year round is a necessity. When planning a roof garden, it is important to include storage for gardening equipment and incorporate

adequate accessibility to ensure easy maintenance. Planting is completely dependent on the roof structure. Shade trees can be used with careful planning and preparation but should be limited and only used when the structure can adequately support them. Where planting depths allow, shrubs and ornamental trees can be used. Roof gardens need consistent and adequate resources to thrive, thus regular maintenance and easy access must be carefully considering and planned for when designing a roof garden.

There are many paving systems for roof gardens, and the roof structure will need to be carefully considered. All hardscaping materials should relate to the building and surrounding context and should adhere to the guidelines for hardscaping.

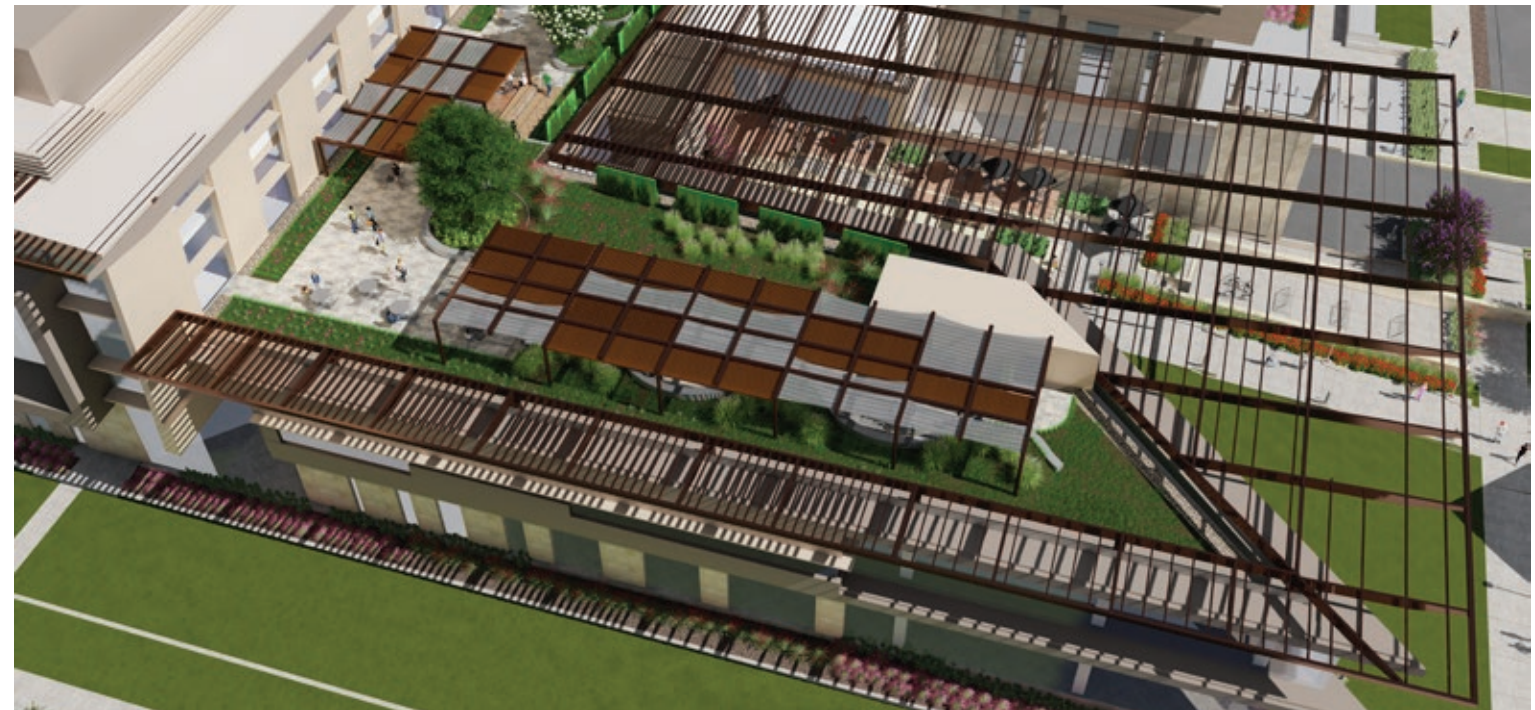

Proposed Roof Garden at Zachary Engineering Education Complex

Open Space

Open spaces are typically large landscape areas that are mostly un-programmed and consist of more softscape than hardscape. These areas tend to be more natural and less “designed,” allowing for more informal use.

Park

Campus parks provide enough open space that they can simultaneously facilitate active and passive users. Sweeping turf areas for recreation, jogging paths, and gathering areas all promote a wide variety of routines and events in these multi-use spaces. Parks are primarily open and mostly turf-ed softscapes with a plethora of shade trees for protection from the hot Texas sun. They are appropriate throughout campus; however, they are highly effective on the periphery of campus where they buffer campus density from the City of College Station.

Parks can also consist of mature natural landscapes, which highlight the region’s native vegetation. Canopy trees are recommended for providing shade and comfort. Trees can be consistently spaced but don’t just have to line the sidewalk. These trees can fill the open space to provide shade. Shrubs and accent plantings should be planted in large masses and used sparingly. Open lawn should be predominating ground plane treatment.

Natural areas are ideal for unpaved walking trails and possibly an educational signage component identifying and emphasizing important features of the landscapes. Standard integral color concrete, exposed aggregate, concrete pavers should be used sparingly depending on campus context. Gravel paths with a 12” concrete border can be used in these areas. Plain concrete is to be avoided.

Seating is important for both the active and passive park user. More private seating is appropriate for people eating their lunch in the park or taking a nature break during the work day. People using the park for an afternoon stroll or a pick-up game of disc golf with friends need seating in close proximity to activity for rest and relaxation. Safety is paramount to any university location; therefore, good lighting and proper plant selection are critical to keeping parks on campus safe and desirable for all users.



Rendering of Proposed Hensel Park re-design

Natural Creek

Campus areas that still exist in their natural form should be preserved to the greatest extent possible. These natural areas are important for storm water management, and preserving the existing native tree canopy helps to minimize Texas A&M's carbon footprint. Additionally, these areas can be used for educational opportunities and passive recreation. Mulch trails for hiking with places of respite should be added to enhance the outdoor experience and attract not only student, faculty, and staff but also members of the community.

In best case scenarios, natural creek areas are undisturbed and populated with native vegetation. However, oftentimes natural creeks in urban areas have been disturbed and overused, resulting in invasive species and erosion problems. Minimal additional softscaping needs to be added to these areas; however, supplemental native planting can be added to help strengthen the health of the ecosystem and for improved erosion control. native varieties, done sparingly, and with the native ecoregions in mind.

Natural creeks in urban areas have their own maintenance requirements. Invasive and noxious weeds, debris (environmental and human), sediment control, animals, insects, and erosion control are all important elements of the natural ecosystem that need to be managed. When incorporating these spaces into the campus landscape, regular periodic care must be included in the maintenance plan.

Standard integral color concrete, exposed aggregate, concrete pavers should be used sparingly depending on campus context. Gravel paths with a 12" concrete border can be used in these areas. Plain concrete is to be avoided. Seating in natural areas should be sparsely located to minimize hardscape interventions. Minimal lighting and hardscape interventions should be made in these areas. Lighting along trails or parking areas is appropriate to keep trails safe after dark. Natural areas are also rife with educational possibilities; a signage/educational component could be added with minimal impact on the native ecosystem.



White Creek



White Creek Detention Area

White Creek Detention Area

- Detention basins are being developed within the White Creek area to improve stormwater run-off from the campus
- Multi-use paths and trails adjacent to overflow areas
- Naturally re-tree and lost trees due to detention basin additions
- Exterior lighting should be placed throughout to address user safety

Educational

Landscapes as interpretive or educational features align with Texas A&M's goal to develop the campus as a learning laboratory. Historically, the agricultural landscapes north of the University have been heavily used for educational and research purposes, while the central landscapes of campus have been used for more utilitarian or aesthetic purposes.

The Gardens at Texas A&M University on the western side of campus supports a recent focus for the use of green space and plant material on campus as an educational tool and a community resource. These demonstration gardens are meant to be accessible to all students and community members and highlight educational opportunities and initiatives.

As campus grows, it is imminent that new opportunities will present themselves to use landscapes as an educational or research tool. There should be a focus on using underutilized green spaces as places for interim educational initiatives as the campus continues to develop. For example, Research Park has acres of green space that could be utilized in the short-term for educational purposes, while that area is developing. In alignment with all of the landscape programs in this section, bringing campus users to these open areas aids in energizing the zone activity and purpose.

If education is the primary goal for a green space, signage is an important component in the ultimate success of the space. Spaces, such as the existing green roofs and bioswales in the eastern areas of campus, should incorporate educational signage as a way to teach users about green technologies.

Educational spaces vary in size and structure. They may range in size from large fields to smaller exhibits with winding, gravel paths that lead students along an educational route. Outdoor educational spaces should have plenty of seating available to accommodate the outdoor classroom environment. Site and garden walls are encouraged and lend themselves to additional seating opportunities for students who have gathered for an outdoor lecture. Lighting must ensure safety for use after dark, especially if evening classes incorporate outdoor classroom time. More ambient lighting choices, such as wall lights, step lights, and bollards, are also appropriate for educational spaces.



The Gardens at Texas A&M, Douglas F. Welsh - 2013

Athletics/Recreation

Athletics and recreation are an essential part of life on a university campus, and these spaces should not only be located throughout campus but also within close proximity to student housing. Athletic and recreation areas are characterized by large turf fields available for a variety of sports activities. Some areas need to be specifically designed to properly accommodate the users, such as tennis courts and baseball/softball diamonds.

Texas A&M has a unique athletics and recreation space at the Simpson Drill Field, which is traditionally used by the Corps of Cadets. When not in use for drill practice, the area easily accommodates pick-up Ultimate Frisbee and touch football games but also supports passive recreation like hacky sac and tossing a baseball. Athletics and recreation areas need to consider circulation, integrated seating, and gathering spaces. These areas also need to include shade and some softscape improvements. Adjacencies to restroom facilities are ideal, although some may include their own restroom facility. Proximity to adjacent buildings could also allow for the use of shared restrooms. Additional examples of successful recreation spaces unique to Texas A&M's campus are the polo fields, campus golf course, and the Penberthy Rec Sports Complex, which are located across campus, ensuring equitable access to recreation for all.

Athletic and recreational spaces need to be able to accommodate large numbers of people and allow for easy pedestrian flow without vegetative barriers. Canopy trees are recommended for providing shade and comfort. Trees can be consistently spaced but do not have to formally line the sidewalk. Shrubs and accent plantings should be planted in large masses and considered a higher maintenance area due to their predominant location and visibility.

Athletic and recreational spaces should have plenty of seating to accommodate the large numbers of people who regularly use these spaces. Site and garden walls are encouraged and lend themselves to additional seating opportunities for students who have gathered for an evening game of flag football or pick up soccer. Standard integral color concrete, exposed aggregate, and for higher profile areas concrete and clay pavers are allowed depending on campus context. Plain concrete is appropriate in intermural areas. Lighting is done differently in athletic and recreation areas than in other campus areas. Since they are characteristically used more often after hours, courts and fields must be well lit with high mast sports lighting, for optimal illumination and so that activities can occur safely after dark. Since athletic and recreational spaces are often heavily used during evening hours, lighting must ensure safety for use after dark and be appropriately sized to accurately light playing fields. More ambient lighting choices, such as wall lights, step lights, and bollards, are also appropriate for lighting perimeter areas.



Penberthy Recreation Sports Complex

Parking Areas

Parking demands on campus are high due to the large amount of commuters traveling to campus each day, as well as the large number of athletics, and other, events held on campus. Because of the inevitable need for campus parking, clear guidelines will better incorporate these areas into the overall campus network. As parking lots and structures move towards the campus perimeter, pedestrian connections should be strongly aligned with parking areas to efficiently move pedestrians toward the campus center.

Surface parking lots should incorporate islands with shade trees, shrubs, groundcovers, and grasses to help reduce the heat-island effect, as well as create a more visually pleasing space. Fewer but larger islands are preferable with the width being determined by the 15 year drip line of the largest shade tree variety chosen for the plan. Canopy trees are recommended to provide shade and comfort. Plantings need to be properly spaced so as not to interfere with vehicle and pedestrian accessibility and plant growth. To ensure ease of care and rejuvenation after damage, herbaceous vegetation should be placed closest to vehicles. Woody shrubs can be in the center of islands and adjacent beds. Naturalized plantings in parking lots are discouraged due to excessive campus resource requirements. Turf immediately adjacent to parking areas is also discouraged for similar reasons. To help mitigate storm water runoff, permeable paving and retention areas, such as bioswales and raingardens, are encouraged.

The use of permeable paving and naturalized drainage areas, such as bioswales or raingardens, will help mitigate runoff, but retention areas must be adequately sized to effectively hold water. Retention areas that are too small can become a trip hazard for individuals accessing vehicles or a repository for debris and excess silt deposits.

The outside edge of surface lots should be planted with shrubs and grasses to help screen vehicles. Leave a 24" (after 3 years of growth) gap between the edge of the plantings and the back of the curb. Utilizing parking blocks will keep car bumpers from hanging over into the landscape. All plantings near intersections and egresses must not obscure site lines.

All walkways connecting drivers to/from the parking lot need to be well lit for safety after dark. Campus standard light for roadway and parking areas should be followed in parking areas to ensure safety after dark. To minimize light obstruction, it is recommended to plant trees no closer than 11' of light poles.



Parking Lot 61



Sustainability

Sustainability in the landscape hinges on plant selections that are resilient to local climate conditions and contribute to low-impact stormwater management strategies. Implementing low-impact landscape design strategies across campus is one of the best ways that Texas A&M can preserve and improve its natural resources and landscape environment. For a more in depth discussion of low-impact design strategies, see the stormwater management section of Chapter Five.

Choosing vegetative materials from the recommended plant list (page XX) ensures that new plantings will have a high likelihood of succeeding in Texas A&M's challenging growing conditions. Plants on the recommended plant list include resilient native and adaptive plants that can thrive in College Station's climate. While native and adaptive plantings will still require organic material and fertilizer application, using the recommended plantings will reduce irrigation and other maintenance requirements, thus decreasing softscape's impact on the campus environment when compared with turf grass or non-native specimen plantings.

Stormwater management methods, such as bioswales, rain barrels, and other methods, manage storm water on site and keep it from overwhelming below-grade piping infrastructure and contributing to the erosion of surrounding creeks. Low-impact design strategies that use vegetation as a means of filtering out pollutants such as chemicals, fertilizers, and other urban debris also maintain the highest possible water quality and will support Texas A&M University in being a good neighbor to downstream communities.

Green roofs, walls, and screening elements have gained popularity as their environmental and aesthetic values have become more apparent and understood. These contemporary green design features are already being incorporated on campus, and their continued and increased use going forward will positively impact campus' environmental footprint.

By using the recommended plantings and implementing the low-impact stormwater management strategies described in Chapter Five, Texas A&M will not only be an example for other universities looking to decrease their environmental footprint but also ensure that future generations of students, faculty, and staff have the opportunity to fully experience the natural beauty and resources of campus.



Rain Garden at ISLB

Maintenance and Resiliency

As with any designed campus space, it is only as successful as its maintainability and overall resiliency and longevity dictate. As such, it is critical to anticipate potential post care or funding limitations for any proposed landscape project, and a thorough knowledge of the campus' maintenance allocation, both in terms of staff size and budget, is necessary for choosing the most appropriate softscape and hardscape materials.

Vegetation that is grown by and/or selected from a reputable grower/ supplier is critical for initial plant health and long-term resiliency. In addition, appropriate plant selections, such as Texas native or adaptive plants that can handle the Post Oak Savannah and Blackland Prairie ecoregion conditions, must be made. Continued plant health can be maintained through best gardening practices, such as regular mulching and fertilizing, proper pruning, adequate irrigation, and general plant care. If any of these optimal growing conditions are not easily met, it may be necessary to adjust the design or work to ensure conditions are improved.

Hardscaping and site furnishings must also follow similar resiliency and longevity guidelines by choosing materials and brands that are reputable, have sound structural integrity, and are meant to last in the public realm. Since material choices will be made for heavily-used areas, it is imperative that proper installation methods are followed, so as to not invalidate any warranties or compromise any product integrity.

Even the healthiest plants can die and the most durable materials can wear out over time. As such, it is important that the University anticipates these occasional replacements/upgrades and allocate funds for the future, ensuring the continued overall beauty and structure of the landscape.



Resilient Plantings at Wellborn Road and Old Main Drive underpass



The reality of maintenance

PLANT LIST

The following plant list includes trees (shade/medium/ornamental), evergreen shrubs, ornamental grasses, grass-like plants, screening plants, naturalized/biofiltration plants, ground covers, annuals (for color), perennials and other shrubs, vines, and turf grasses that are recommended as suitable Texas native and adaptive species for the Post Oak Savannah and Blackland Prairie ecoregions.

The plant list has been broken down into 75% and 25% categories. The goal is for the broader campus landscape structure to come from the 75% plant list, ensuring visual continuity as well as improving the strength and longevity of the landscape through plant material that is best suited for the challenging campus environment. The 25% plant list is for small gathering areas, or “special spaces,” where unique areas with site specific soft and hard scape materials bring diversity to the campus outdoor experience. These plants may need additional maintenance or micro-climate zones where they can be featured as specialty plantings.

This list is not all inclusive, and designers wishing to incorporate vegetative material not on this list must consult with the Office of the University Architect before including it in their design.

SHADE TREES

<https://www.thetreecenter.com/wp-content/uploads/2014/06/american-sycamore-2.jpg>



American Sycamore,
Platanus occidentalis

http://www.wildflower.org/gallery/result.php?id_image=14980



<http://www.ci.blaine.mn.us/images/misc/trees/buroak-summer.jpg>



Bur Oak,
Quercus macrocarpa

http://www.plymouth.org/images/thumbnails/bur_oak_tree.jpg



https://austintexas.gov/sites/default/files/CedarElm_0.jpg



Cedar Elm,
Ulmus crassifolia

http://www.tree-land.com/images/cedar_elm_tree.jpg



<http://wildlifemanagementtrees.com/media/8232653d-a658-4130-9988-1a89167942115004072/wildlifemanagementtrees.com/images/4%20F%20oak%20and%20oak%20tree%20trees%20trees%20oak.jpg>



Chinkapin Oak,
Quercus muehlenbergii

<http://austintexas.gov/department/growgreen-plant-guides/oak-chinkapin>



<http://www.halkanursery.com/wp-content/uploads/2014/04/20140819-bald-Cypress-1-393x590.jpg>



Common Bald Cypress,
Taxodium distichum

<http://www.innovative-outdoors.net/wp-content/uploads/2013/09/bald-cypress.jpg>



<http://www.kurtelison.com/scout-plants/live-oak-b12.jpg>



Live Oak,
Quercus virginiana

https://www.tree-land.com/images/live_oak_tree.jpg



https://i1.staichick.com/1728466075424_30dad94444_b.jpg



Mexican Sycamore,
Platanus mexicana

<https://pics.davesgarden.com/pics/2006/10/02/jeeboom63a034.jpg>



https://www.tree-land.com/images/Monterrey_Oak_Mature.jpg



Monterrey Oak,
Quercus polymorpha

<http://pics.davesgarden.com/pics/2006/10/02/jeeboom63a034.jpg>



https://www.dirtdoctor.com/www/default/cv/kinder/user/files/1114/images/TREES/Montezuma%20Cypress_new_0105.jpeg



Montezuma Cypress,
Taxodium distichum var. *mexicanum*

<http://southwestgarden.com/uploads/347/14/34/112/34659602.jpg>



<https://s-media-cache-ak0.pinimg.com/236x/9/b/a/a79bca/9e993c7e9f15d63e2629892c.jpg>



Pond Cypress,
Taxodium distichum var. *imbricarium*

https://i2.staichick.com/4/3118/2839625195_067699ae3_b.jpg



SHADE TREES

<http://dendro.cme.vt.edu/dendroblog/images/Quercus%20shumardii/form1.jpg>



<http://www.carolinanature.com/trees/quish50661.jpg>



Shumard Oak,
Quercus shumardii

<http://www.august.aga.gov/images/pages/NI1637/Southern%20Magnolia%20-%20Photo%204.jpg>



http://alldesktop.com/data_images/original/4241019-magnolia.jpg



Southern Magnolia,
Magnolia grandiflora

<https://selecttree.calpoly.edu/images/1200/64/original/quercus-buckleyi-tree-3.jpg>



http://web.gccaz.edu/galleries/images/Quercus_buckleyi_3.jpg



Texas Red Oak,
Quercus buckleyi

http://cdn2.bigcommerce.com/server4900/gp99ab/product_images/uploaded_images/water-oak.jpg?1=1441246733



<http://www.carolinanature.com/trees/quini1300629.jpg>



Water Oak,
Quercus nigra

<http://caseytreecare.org/wp-content/uploads/2012/03/VF-ferm.jpg>



http://www.tree-land.com/images/facebook_elm_tree_1.jpg



Willow Oak,
Quercus phellos

MEDIUM TREES

<p>http://www.discounttreesofbrenham.com/files/5214405977964/Arizona_Cypress.jpg</p>		<p>http://www.plantsystematics.berkeley.edu/Cupressus/ArizonaCupressus-arizonic.jpg</p>		<p>Arizona Cypress, <i>Cupressus arizonica</i></p>
<p>http://www.austintexas.gov/sites/default/files/CherryLaurel.jpg</p>		<p>http://www.abutexas.edu/bio-0060/images/Prunus%20caroliniana%20leaves.jpg</p>		<p>Cherry Laurel, <i>Prunus caroliniana</i> spp.</p>
<p>http://www.treesofbrenham.com/wp-content/uploads/2015/06/Pistache-Chinese.jpg</p>		<p>http://www.treesofbrenham.com/wp-content/uploads/2015/12/Juniperus-virginiana.jpg</p>		<p>Chinese Pistache, <i>Pistacia chinensis</i></p>
<p>http://www.discounttreesofbrenham.com/files/391379451705/eastern_red_cedar.jpg</p>		<p>http://www.treesofbrenham.com/wp-content/uploads/2015/12/Juniperus-virginiana.jpg</p>		<p>Eastern Red Cedar, <i>Juniperus virginiana</i></p>
<p>http://www.vcmga.org/yahoo_site_admin/assets/images/12Apr03NarrowLandscapeBlueberry_06090114_std.jpg</p>		<p>http://www.onlineplantguide.com/image%20library/11971.jpg</p>		<p>Japanese Blueberry Tree, <i>Elaeocarpus decipiens</i></p>
<p>http://www.tamie.com/wp-content/themes/horizon/admin/extensions/fthumb.php?file=3427&f=www.tamie.com%2Fwp-content%2Fuploads%2F131-detail.jpg&w=612</p>		<p>http://www.avondalewatersavingplants.com/PlantMaster/Photos/2097a.jpg</p>		<p>Lacebark Elm, <i>Ulmus parvifolia</i></p>
<p>http://www.carolinanature.com/trees/ulm/230495.jpg</p>		<p>http://www.avondalewatersavingplants.com/PlantMaster/Photos/2097a.jpg</p>		<p>Mesquite, <i>Prosopis glandulosa</i></p>
<p>http://www.treesofbrenham.com/wp-content/uploads/2015/06/Pistache-Chinese.jpg</p>		<p>http://www.treesofbrenham.com/wp-content/uploads/2015/06/Pistache-Chinese.jpg</p>		<p>River Birch, <i>Betula nigra</i></p>
<p>http://imgcache01.verio.com/35184048/view76x68A.html</p>		<p>http://www.abutexas.edu/bio-0060/images/pcs/06/leaves%20n%20300.jpg</p>		<p>Texas Ash, <i>Fraxinus texensis</i></p>

ORNAMENTAL TREES

<p>https://s-media-cache-a0.pinning.com/736w/4770d/91470/09fbanc8e5021d3b9e5d01250a7.jpg</p> 	<p>http://www.discountrreesobrenham.com/files/53142446/8126/bubba.jpg</p> 	<p>http://www.mswn.com/media/tbeer/plants/rhus_virens_ver_387.jpg</p> 	<p>https://www.theplantingtree.com/media/catalog/product/cache/1/image/1200x/043d080142c94223bed35ca3133827/fo/for/est/pansy-redbud-3.jpg</p> 	<p>http://www.wildflower.org/image_archive/640x480/AM6151/6151_IMG001391.jpg</p> 
<p>https://terradincognita.files.wordpress.com/2009/08/usc0181961.jpg</p> 	<p>Coleman & Associates</p> 	<p>http://www.wildflower.org/uploads/2010/04/ML500_IMG0032.JPG</p> 	<p>http://media.oregonlive.com/homesandgardens/uploads/2010/05/2692269.jpg</p> 	<p>http://www.countyisdustin.com/wp-content/uploads/2010/05/mexbuckeye.jpg</p> 
<p>Common Crapemyrtle, <i>Lagerstroemia indica</i></p>	<p>Desert Willow, <i>Chilopsis linearis</i></p>	<p>Evergreen Sumac, <i>Rhus virens</i></p>	<p>Forest Pansy Redbud, <i>Cercis canadensis</i></p>	<p>Mexican Buckeye, <i>Ungnadia speciosa</i></p>
<p>http://weedwaterwatchm.com/wp-content/uploads/2016/03/earlyspring.jpg</p> 	<p>http://www.wildflower.org/image_archive/640x480/PCD3937/PCD3937_IMG0010.JPG</p> 	<p>http://www.penicknerdiggimg/images/2010_01_20/Possumhaw_in_berry_2.jpg</p> 	<p>https://s-media-cache-a0.pinning.com/544w/bd/bd/95/bbb959f5e3514721f900029c2b955d.jpg</p> 	<p>http://4.bp.blogspot.com/N3w25Ac03e/ULU9ZlhpC5/AAAAAAAAACRQ/boptTjert5ww/st1600/Purple-Leaf-Plum.jpg</p> 
<p>http://haulfc.org/wp-content/uploads/2013/11/MexicanPlum-flower.jpg</p> 	<p>http://aggie-horticulture.texasaam.edu/orchardnursery/atwebsites/FILES/FILES/SCA/164240.jpg</p> 	<p>http://img808.images.flickr.com/2008/05/Possumhawholly.jpg</p> 	<p>http://www.wildflower.org/uploads/2010/04/ML500_IMG0046.JPG</p> 	<p>http://hickorycreeknursery.com/wp-content/themes/2k4/purpleofplumbloom-628x250.jpg</p> 
<p>Mexican Plum, <i>Prunus mexicana</i></p>	<p>Mexican Redbud, <i>Cercis canadensis var. mexicana</i></p>	<p>Possomhaw Holly, <i>Ilex decidua</i></p>	<p>Prairie Flameleaf Sumac, <i>Rhus lanceolata</i></p>	<p>Purple Leaf Plum, <i>Prunus cerasifera</i></p>

ORNAMENTAL TREES

http://www.landscapehilltophead.com/uploads/70/29/3/70333343/3700926_016.jpg



Southern Waxmyrtle,
Myrica cerifera

<http://www.carolinanature.com/trees/mocce1170893.jpg>



<http://saxonson.com/sites/default/files/styles/default/public/texas.jpg?tok=odfahyl>



Texas Mountain Laurel,
Sophora secundiflora

http://www.penicill.net/digitalimg/15%2033_07.jpg



<http://www3.templejc.edu/Campus/Landscape/photos/Plants/TexasRedbud.jpg>



Texas Redbud,
Cercis canadensis var. texensis

<http://www.willbress.com/files/IMG01283.JPG>



https://media.licdn.com/mp/mpi/shrine.qp_800_800/AALFAAQAAAAAAAAAAAAAAAAAAGVAMGXWJLIT030DcNGViy1INGQALpMTMwMwrmjpmkg.jpg



Tree Yaupon,
Ilex vomitoria

<http://www.carolinanature.com/trees/ivo3412.jpg>



EVERGREEN SHRUBS

https://www.hilltoplandscaping.com/wp-content/uploads/boxwood_3.jpg



Boxwood,
Buxus microphylla

<https://s-media-cache-ak0.pinimg.com/736x/d9/81/12/d9811250565949ff7948102a1f88>



Burford Holly,
Ilex cornuta 'Burfordii'

<https://plants.com/wp-content/uploads/2014/09/Chinese-Fringe-Flower-Finger.jpg>



Chinese Fringe Flower,
Loropetalum chinense

<https://www.hilltoplandscaping.com/wp-content/uploads/2014/09/Callistemon-citrinus-rod-custer-1.jpg>



Common Bottlebrush,
Callistemon citrinus

<https://s-media-cache-ak0.pinimg.com/736x/1b/0d/81/1b0d811c25c5f932b823c05f.jpg>



Dwarf Burford Holly,
Ilex cornuta 'Dwarf Burford'

https://as.comconnect.com/s3.amazonaws.com/100_0006-1-0391FD1FA0826276.jpg



Dwarf Palmetto Palm,
Sabal minor

<https://s-media-cache-ak0.pinimg.com/736x/8d/b1/02/8db10251486145625c283181.jpg>



Dwarf Waxmyrtle
Myrica cerifera

<https://s-media-cache-ak0.pinimg.com/736x/5f/1d/25/5f1d251894201b0b04a1b1838c.jpg>



Dwarf Yaupon,
Ilex vomitoria

<https://s-media-cache-ak0.pinimg.com/736x/1d/07/f0/1d07f011c25c5f932b823c05f.jpg>



Flowery Senna,
Senna corymbosa

<http://7765-dc50721p15s1muu4dmlk.uploads.pinterest.com/21883988/>



Glossy Abelia,
Abelia x grandiflora

http://www.robspants.com/images/stock_small/15.jpg



Gray Cotoneaster
Cotoneaster glaucophyllus

http://www.stmaisonplant.com/images/1614_7936179304.jpg



Indian Hawthorn,
Raphiolepis spp.

<https://www.gardensdirect.com/public/img/aucuba.jpg>



Japanese Aucuba,
Aucuba japonica

http://columnnet.com/DCS_0107_cpk.jpg



Japanese Pittosporum,
Pittosporum tobira

<http://s-media-cache-ak0.pinimg.com/736x/8d/b1/02/8db10251486145625c283181.jpg>



Japanese Yew,
Podocarpus macrophyllus

<http://www.plantoftheweek.com/magaz/2014.jpg>



Mahonia,
Mahonia bealei

<http://www.thegardens.com/sabulifer/content/uploads/2011/06/nandina-01.jpg>



Nandina,
Nandina domestica

<http://www.thegardens.com/sabulifer/content/uploads/2011/06/nandina-01.jpg>



Nellie R. Stevens Holly,
Ilex cornuta

http://zpropagata.com/imagenes/primrose_jas.jpg



Primrose Jasmine,
Jasminum mesnyi

<http://s-media-cache-ak0.pinimg.com/736x/27/1b/1f/271b1f11c25c5f932b823c05f.jpg>



Rosemary,
Rosmarinus officinalis

EVERGREEN SHRUBS

Coleman & Associates



Sago Palm,
Cycas revoluta

<https://www.royalbotanicgardens.com/2078/Sandankwa-Viburnum.jpg>



Sandankwa Viburnum,
Viburnum suspensum

**PERENNIALS & OTHER
SHRUBS**



Artemisia,
Artemisia x 'Powis Castle'



Bulbine,
Bulbine frutescens



Firecracker Fern,
Russelia equisetiformis



Giant Hesperaloe,
Hesperaloe funifera



Lily-Of-The-Nile,
Agapanthus africanus



American Beautyberry,
Callicarpa americana



Daylily,
Hemerocallis spp.

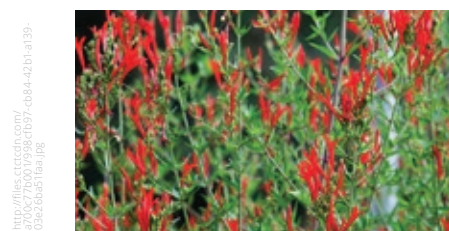

Flame Acanthus,
Anisacanthus quadrifidus



Giant Turk's Cap
Malvaviscus arboreus var. *drummondii*



Louisiana Hybrid Iris,
Iris x 'Louisiana Hybrids'



Blue Nolina,
Nolina nelsoni



Dwarf Pomegranate,
Punica granatum



Fragrant Sumac,
Rhus aromatica



Inland Sea Oats,
Chasmanthium latifolium



Mexican Heather,
Cuphea hyssopifolia



Blue Plumbago,
Plumbago auriculata



Firebush,
Hamelia patens

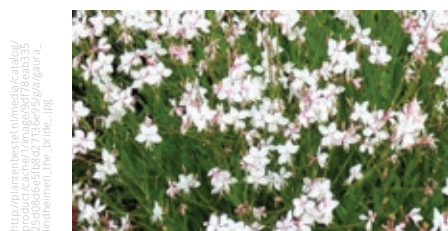

Gaura,
Gaura lindheimeri



Jerusalem Sage,
Phlomis fruticosa



Mexican Mint Marigold,
Tagetes lucida

PERENNIALS & OTHER SHRUBS



<https://www.burkebach.com/content/uploads/2016/05/Oakleaf-Hydrangea-1024x768.jpg>

Oakleaf Hydrangea,
Hydrangea quercifolia



https://www.plantsofamerica.com/pride_of_barbados.jpg

Pride-Of-Barbados,
Caesalpinia pulcherrima



<https://www.comfreespecies.com/wp-content/uploads/2016/04/red-yucca-parviflora.jpg?resize=658%2C553>

Red Yucca,
Hesperaloe parviflora



<https://www.mediterranean.com/wp-content/uploads/2016/04/Perovskia-atriplicifolia.jpg>

Russian Sage,
Perovskia atriplicifolia



http://www.robustplants.com/images/plant/index/viburnum_rufidulum.jpg

Rusty Blackhaw Viburnum,
Viburnum rufidulum



https://www.robustplants.com/images/plant/index/philodendron_bipinnatifidum.jpg

Split-Leaf Philodendron,
Philodendron bipinnatifidum



https://www.robustplants.com/images/plant/index/lantana_urticoides.jpg

Texas Lantana,
Lantana urticoides



<https://www.mediterranean.com/wp-content/uploads/2016/04/Leucophyllum-frutescens-varieties.jpg>

Texas Sage,
Leucophyllum frutescens 'varieties'



https://www.robustplants.com/images/plant/index/dasylirion_texanum.jpg

Texas Sotol,
Dasylirion texanum



https://www.robustplants.com/images/plant/index/lantana_montevidensis.jpg

Trailing Lantana,
Lantana montevidensis



https://www.robustplants.com/images/plant/index/turks_cap.jpg

Turk's Cap,
Malvaviscus arboreus var. mexicanus



https://www.robustplants.com/images/plant/index/alpinia_zerumbet.jpg

Varigated Ginger,
Alpinia zerumbet



https://www.robustplants.com/images/plant/index/dietes_iridioides.jpg

White Butterfly Iris,
Dietes iridioides



https://www.robustplants.com/images/plant/index/tecoma_stans_var_angustata.jpg

Yellow Bells,
Tecoma stans var. angustata



https://www.robustplants.com/images/plant/index/dietes_bicolor.jpg

Yellow Bicolor Iris,
Dietes bicolor



https://www.robustplants.com/images/plant/index/hesperaloe_parviflora.jpg

Yellow Yucca,
Hesperaloe parviflora



https://www.robustplants.com/images/plant/index/wedelia_hispida.jpg

Zexmenia,
Wedelia hispida

ORNAMENTAL GRASSES

http://austinnativeplants.com/site/Pictures/Bamboo_Muhly.jpg



Bamboo Muhly,
Muhlenbergia dumosa

<http://s3.amazonaws.com/cdn-images-1-us-east-1.amazonaws.com/132105865294817941024.jpg>



Deergrass,
Muhlenbergia rigens

<http://www.thespruce.com/132105865294817941024.jpg>



Gulf Muhly,
Muhlenbergia capillaris

<http://www.thespruce.com/132105865294817941024.jpg>



Lindheimer Muhly,
Muhlenbergia lindheimeri

<https://plantdatabase.kpcu.ca/images/habit/myside.jpg>



Maidengrass,
Miscanthus sinensis

<http://175.03.59.72/pics/annuals/flowers/uploads/plants/origmab/3116.jpg>



Purple Fountain Grass,
Pennisetum alopecuroides

GROUNDCOVERS

http://www.theflorist.com/assets/images/Asian_Jasmine_6.jpg



Asian Jasmine,
Trachelospermum asiaticum

<http://img.ahrc.ca.org/ahrc/ahrc/ahrc/media/0/01378-Asparagus-densiflorus.jpg>



Asparagus Fern,
Asparagus densiflorus

<http://media1.burtonisaacs.com/media/0/01378-Asparagus-densiflorus.jpg>



Cast Iron Plant,
Aspidistra elatior

<http://www.onlinepanorama.com/image420/library/4528.jpg>



Trailing Juniper
Juniperus horizontalis

<http://www.nerveless.com/wp-content/uploads/2011/07/01.jpg>



Foxtail Fern,
Asparagus densiflorus

<http://www.davesgarden.com/pics/20040624/top88290.jpg>



Frogfruit,
Phylla nodiflora

<http://www.orchidnursery.com/images/fern-holly.jpg>



Holly Fern,
Cyrtomium falcatum

<http://www.chryson.com/ftp/gogol-wizard/images/musc/LIRIOPUS.jpg>



Liriope,
Liriope muscari

<http://www.nerveless.com/wp-content/uploads/2011/07/01.jpg>



Mondo Grass (Monkey Grass),
Ophiopogon japonicus

<http://www.davesgarden.com/pics/20100520/10071-Dichondra-argentea-Silver-Ponyfoot-10071.jpg>



Silver Pony Foot,
Dichondra argentea

<http://www.orchidnursery.com/images/fern-wood.jpg>



Varigated Liriope,
Liriope muscari

<http://www.orchidnursery.com/images/fern-wood.jpg>



Wood Fern,
Thelypteris kunthii

CLIMBING VINES

http://www.tropicalforages.info/keys/forages/ternatea_01.jpg



Butterfly Pea,
Clitoria ternatea

<https://s-media-cache-ak1.pinimg.com/736x/48/89/896482114e9.jpg>



Coral Honeysuckle,
Lonicera sempervirens

<http://www.blossoms.com/LOJ/2/27sw/51600/carolina%20jessamine%20.jpg>



Carolina Jessamine,
Gelsemium sempervirens

<https://www.ontarioparks.com/img/2012/07/10/26.jpg>



Evergreen Wisteria,
Millettia reticulata

<http://www.tropicalforages.com/wp-content/uploads/2013/07/7.jpg>



Fig Ivy,
Ficus pumila

https://upload.wikimedia.org/wikipedia/commons/4/4c/Parthenocissus_quinquefolia_169.jpg



Virginia Creeper,
Parthenocissus quinquefolia

<http://gardens.tumblr.com/photos/13325290413/anna-confederate.jpg>



Confederate Jasmine,
Trachelospermum jasminoides

TURF

http://www.insecticidesinfo.com/files/1450411/images/Cynodon_dactylon.jpg



Bermudagrass,
Cynodon dactylon

<https://www.researchgate.net/profile/Buchloe-dactyloides/publication/320166277/figure/fig/1/figure/fig1/1517491414944/Buchloe-dactyloides.jpg>



Buffalograss,
Buchloe dactyloides

<http://www.wildflower.com.au/Content/uploads/2016/02/Annual-Ryegrass-Lolium-multiflorum.Pic1.jpg>



Perennial Ryegrass,
Lolium multiflorum

<http://www.turf.com/wp-content/uploads/2014/04/Zoysia-Grass.jpg>



Zoysiagrass,
Zoysia spp.

NATIVE SEED MIXES / WILDFLOWERS (NATIVE AMERICAN SEED)

Blackland Prairie Mix

American Basketflower	Pink Evening Primrose
Annual Winecup	Pitcher Sage
Big Bluestem	Prairie Agalinis
Black-eyed Susan	Plains Bristlegrass
Broomsedge Bluestem	Plains Coreopsis
Buffalograss	Purple Prairie Clover
Butterflyweed	Purpletop
Cane Bluestem	Prairie Verbena
Common Milkweed	Prairie Wildrye
Clasping Coneflower	Rattlesnake Master
Croton	Rose Milkweed
Cutleaf Daisy	Sand Dropseed
Eastern Gamagrass	Sand Lovegrass
Florida Paspalum	Showy Milkweed
Foxglove	Sideoats Grama
Gayfeather	Spiderwort
Green Sprangletop	Standing Cypress
Hooded Windmill Grass	Switchgrass
Illinois Bundleflower	Tall Goldenrod
Indian Blanket	Texas Cupgrass
Indiangrass	Texas Yellow Star
Inland Seaoats	Virginia Wildrye
Lemon Mint	White Tridens
Little Bluestem	Winecup
Maximilian Sunflower	White Rosinweed
Partridge Pea	

South East Recovery Mix (Post Oak Savannah)

Little Bluestem native Colorado County*	Lanceleaf Coreopsis*	Texas Cupgrass
American Aloe*	Lemon Mint	Texas Yellow Star
Balsamscale*	Longspike Tridens*	Three-Awn*
Big Bluestem*	Marsh Elder*	Vervain*
Black-Eyed Susan	Native Sedge*	Maximilian Sunflower
Broomsedge Bluestem*	Partridge Pea*	White Prairie Clover
Brownseed Paspalum*	Plains Coreopsis	Red Lovegrass
Bushy Bluestem*	Prairie Agalinis*	Purple Lovegrass
Cane Bluestem	Prairie Verbena	
Clasping Coneflower	Prairie Wildrye	* seed from prairie remnant conservancy harvest
Common Sunflower*	Purple Prairie Clover	
Croton*	Purpletop*	
Cutleaf Daisy	Ragweed Annual*	
Epazote*	Rattlesnake Master*	
Florida Paspalum*	Red Lovegrass*	
Gayfeather*	Rough Buttonweed*	
Giant Coneflower*	Sand Dropseed	
Green Sprangletop	Sand Lovegrass	
Gulf Coast Muhly	Sideoats Grama	
Gumweed*	Slim Tridens*	
Hairawn Muhlygrass*	Smartweed*	
Hooded Windmill Grass	Splitbeard Bluestem*	
Horned Beaksedge*	Sumpweed*	
Illinois Bundleflower	Switchgrass*	
Indian Blanket	Tall Dropseed**	
Indiangrass*	Tall Goldenrod*	
Knotroot Bristlegrass*	Texas Bluebonnet	

ANNUALS



<https://www.gardeners.com.au/flowers/annuals/salvia-splendens.jpg>

Annual Sage,
Salvia splendens



<https://www.gardeners.com.au/flowers/annuals/evolvus-glomeratus.jpg>

Blue Daze,
Evolvus glomeratus



<https://www.gardeners.com.au/flowers/annuals/caladium-bicolor.jpg>

Caladium,
Caladium bicolor



<https://www.gardeners.com.au/flowers/annuals/solenostemon-scutellarioides.jpg>

Coleus,
Solenostemon scutellarioides



<https://www.gardeners.com.au/flowers/annuals/narcissus-spp.jpg>

Daffodils,
Narcissus spp.



<https://www.gardeners.com.au/flowers/annuals/senecio-cineraria.jpg>

Dusty Miller,
Senecio cineraria



<https://www.gardeners.com.au/flowers/annuals/zinnia-angustifolia.jpg>

Mexican Zinnia,
Zinnia angustifolia



<https://www.gardeners.com.au/flowers/annuals/zinnia-haageana.jpg>

Old Fashioned Mexican Zinnia,
Zinnia haageana



<https://www.gardeners.com.au/flowers/annuals/brassica-oleracea-var-acephala.jpg>

Ornamental Cabbage or Kale,
Brassica oleracea var. acephala



<https://www.gardeners.com.au/flowers/annuals/capsicum-annuum.jpg>

Ornamental Pepper,
Capsicum annuum



<https://www.gardeners.com.au/flowers/annuals/viola-x-wittrockiana.jpg>

Pansy,
Viola x wittrockiana



<https://www.gardeners.com.au/flowers/annuals/petunia-x-hybrida.jpg>

Petunia,
Petunia x hybrida



<https://www.gardeners.com.au/flowers/annuals/antirrhinum-majus.jpg>

Snapdragon,
Antirrhinum majus



<https://www.gardeners.com.au/flowers/annuals/lobularia-maritima.jpg>

Sweet Alyssum,
Lobularia maritima

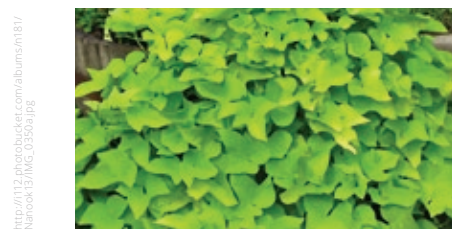

<https://www.gardeners.com.au/flowers/annuals/ipomoea-batatas.jpg>

Sweet Potato Vine,
Ipomoea batatas



<https://www.gardeners.com.au/flowers/annuals/lupinus-texensis.jpg>

Texas Bluebonnet,
Lupinus texensis



<https://www.gardeners.com.au/flowers/annuals/zinnia-elegans.jpg>

Zinnia,
Zinnia elegans





07

HERITAGE CONSERVATION

Introduction

Historic Resource Inventory and Assessment

Resource Stewardship

Preservation Principles

Heritage Conservation Guidelines



INTRODUCTION

Texas A&M University's heritage is reflected in the built environment that provides the unique characteristics that make it different from any other place.

Texas A&M University is recognized as an institution rich in history and tradition by current and former students, faculty, administrators and visitors. The University's heritage is reflected in the built environment that provides the unique characteristics that make it different from any other place. This important physical legacy reinforces and promotes the history and traditions of the University and provides a tangible link to its past. Familiar buildings, vistas and site features contribute not only to the distinctive identity of campus but they reinforce the connection former students have to the University. These are the buildings and spaces where knowledge is gained, memories are made and the Aggie network is forged. The built environment includes historic resources that are architectural, cultural and/or campus assets. Preservation of these resources is crucial to maintaining the identity and sense of place of Aggieland.

While the University has always taken pride in the preservation of its history and traditions, historic resources have been lost. The demolition of historic buildings, removal of character defining features like the tower of the Halbouty Geosciences Building, the wholesale removal of significant interiors like that of the H.J. (Bill) and Reta Haynes Engineering Building (formerly the Civil Engineering Building), or losses of historic fabric from maintenance ultimately send these resources to landfills.

In a desire to protect its built heritage, the University began to develop and plan for the protection of these historic resources in 2001. To celebrate the 125th anniversary of Texas A&M University, the Office of the President allocated funds to the Center for Heritage Conservation in the College of Architecture to commemorate culturally and architecturally significant buildings on campus.

The effort called, "The Campus Remembered: Historic Buildings at Texas A&M University," designated 17 buildings with a bronze plaque inscribed with a brief history of the building. This effort stopped short at only 17 buildings because funding was available for 17 plaques. This was one of first efforts to designate and celebrate the historic buildings on campus and would be the basis for future recognition efforts.

The 2004 Campus Master Plan designated 18 buildings that contribute to the "linkage with the past." The buildings listed in the master plan varied slightly from the "Campus Remembered" program with what was considered significant to the campus built environment. The building periods and styles represented in this listing included only some of the early buildings and excluded any buildings after the depression. This was the first time that designation and preservation of buildings was formalized by the University and authorized by the Board of Regents.

The Historic Core District Plan and Heritage Building Guidelines were created in 2007 as a result of a recommendation in the 2004 Campus Master Plan. Both of these efforts further expanded and developed preservation efforts on campus and utilized the term "heritage" to define significant historic buildings. However, they continued to focus on earlier campus buildings and did not include many of the post-war era buildings constructed during one of the University's most pivotal periods of transformation. The 2017 Campus Master Plan is intended to augment these earlier efforts at identifying and managing historic resources on campus.

The University faces significant challenges in maintaining and preserving its legacy and identity while adapting to changing needs and new technologies to fulfill its mission. It is the steward of a rich collection of historic resources that showcase its proud history and traditions. The Historic Resource Inventory and Assessment, preservation principles, and guidelines contained in this chapter aim to assist the University in the management of these valuable assets, vital to the identity of this institution, for the benefit of future generations of Aggies for years to come.



Redeveloping existing

buildings keeps significant quantities of construction material out of landfills and gives historic buildings renewed life and value on Texas A&M's campus. Preserving existing buildings also maintains continuity for the University's development legacy.

HISTORIC RESOURCE INVENTORY AND ASSESSMENT

Understanding and identifying historic resources is the first step in preservation planning. An inventory and assessment of resources that meet the criteria for eligibility for listing on the National Register of Historic Places was created, using the same standards (National Park Service's criteria and seven aspects of integrity) that are applied by the Texas Historical Commission in its review of University buildings over 50 years of age under the Antiquities Code of Texas. While this inventory does not take the place of an official Texas Historical Commission review, it provides a preview or list of potentially eligible properties that the University can use in planning for how to address these buildings. It is also the initial step in establishing a more prioritized list of resources that can be associated with treatment.

The purpose of identifying and assessing historic resources is to prevent insensitive alterations or unintentional destruction of these resources. The inventory and assessment process was comprised of several activities, including the review of previous identification efforts, historic research, and site visits. Every building constructed prior to 1970 was assessed for its potential to be eligible for listing on the National Register of Historic Places. Buildings built between 1970 and 1975 were addressed in a more cursory manner and are presented as part of a watch list, rather than suggesting potential eligibility.

The inventory and assessment resulted in a prioritization of the buildings on campus, presented in four building designation levels. This effort also identified outdoor spaces, vistas, circulation routes and site features as historic campus resources. These elements are not classified into designation levels, but are noted as historic resources in their own right that shall be considered when planning for the campus.

Building Designation Levels

The historic resources of Texas A&M University consist of a collection of buildings, dating from early campus development in 1909 to the rapid student population growth in the 1950's. Several building types are represented in this collection including educational, administrative, communal and residential.

The University shall strive to preserve and maintain historic resources throughout campus. However, it is not always practical to maintain and preserve every building to the same level. By inventorying, assessing and designating resources, campus assets that contribute to the character and sense of place unique to this campus are highlighted. To support the University in planning the campus environment a designation level system was created to assist in developing meaningful strategies for future development and to enable specific treatment of the most significant resources. The designation levels provide a framework and tools for changes that will occur. Even though a resource is designated at a lower level does not mean it is expendable or that it does not contribute to the historic context of that area of campus. The University shall take every effort to be responsible stewards of the historic resources provided by previous generations of Texans.

The resources designated in this section constitute many layers of architectural styles that mirror the trends popular nationwide at the time of construction. The earliest buildings date from campus development at the turn of the 20th Century, through the depression era with the realignment of campus to the post-war modern era and the rapid growth of campus. The building styles include Classical Revival, Romanesque Revival, regional PWA Moderne, and International Styles.

Building Designation Levels

- Heritage
- Historic
- Secondary Historic
- Buildings 50 years or older

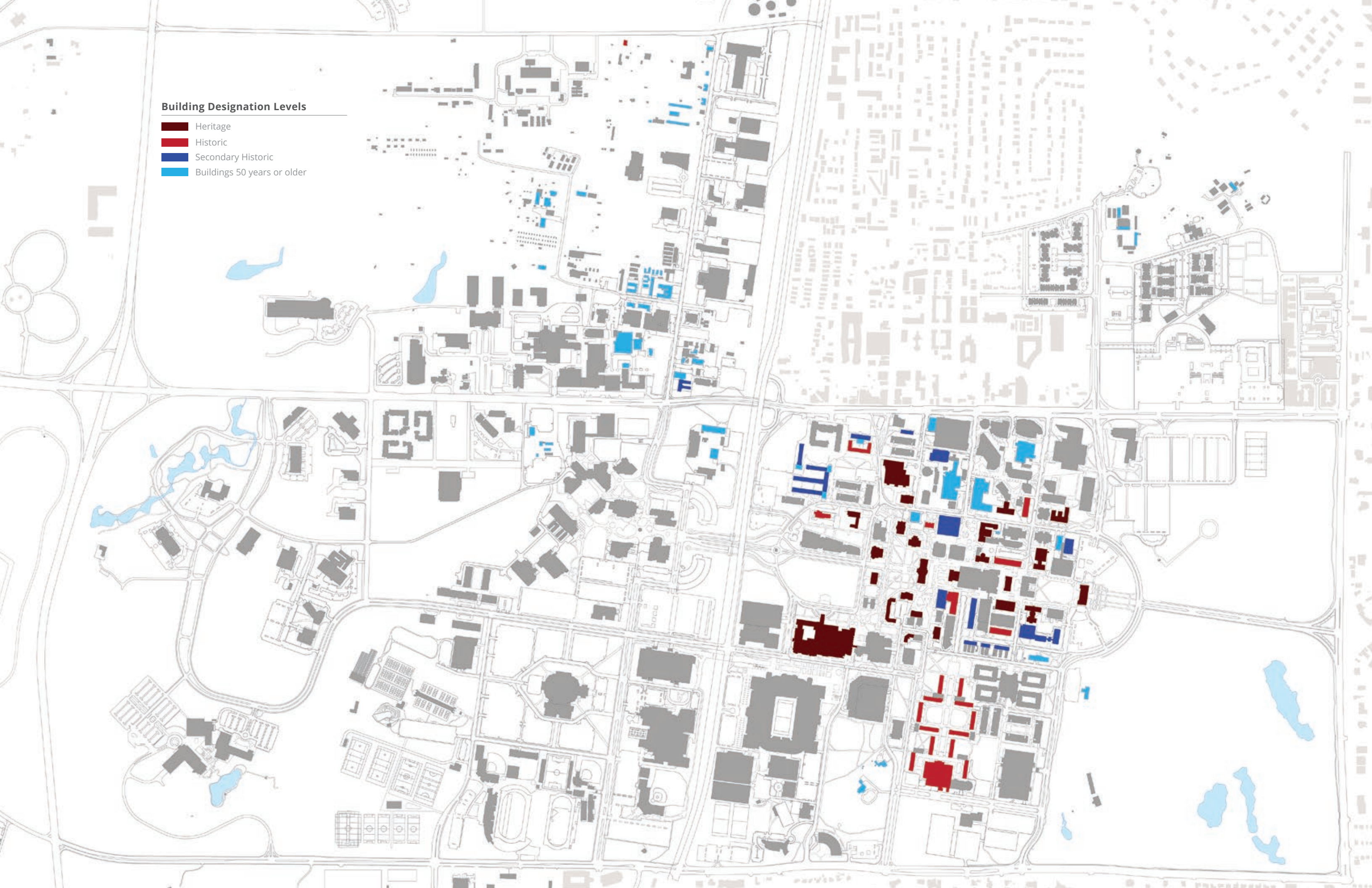

Level 1 — Heritage Buildings

Level 1 - Heritage Buildings are designated with bronze plaques and are those structures with exceptional architectural or cultural significance or that maintain an uncommon level of integrity. Typically these structures retain the majority of their original exteriors, interiors and other unique architectural features in reasonable or repairable condition and significantly contribute to the campus development and history.

Because Level 1 - Heritage Buildings are exceptional historic resources, the University is committed to permanently maintaining and preserving the character defining features of these structures. The character defining features of the exterior and interior are to be preserved or restored. Proposed additions or alterations are to be carefully considered and shall comply with the Heritage Conservation Guidelines contained in this chapter.



Academic Building, 1914

Current Building Name	Bldg #	Date
Nagle Hall	0506	1909
Legett Hall	0419	1911
Milner Hall	0420	1911
Bolton Hall	0480	1911
Sbisa Dining Hall	0495	1912
YMCA Building	0474	1913
Academic Building	0462	1914
Butler Hall	0465	1916
Pavilion	0471	1916
Psychology Building	0463	1920
Melbern G. Glasscock Building	0470	1921
Francis Hall	0476	1922
Military Sciences Building	0456	1923
Cushing Memorial Library	0468	1929
Chemistry Building	0484	1929
Hart Hall	0417	1930
Animal Industries Building	0472	1932
Jack K Williams Administration Building	0473	1932
Scoates Hall	0478	1932
H.J. (Bill) and Reta Haynes Engineering Building (formerly the Civil Engineering Building)	0492	1932
Halbouty Geosciences Building	0490	1933
Memorial Student Center	0454	1951
Coke Building	0461	1951
All Faiths Chapel	0512	1957

Level 1 — Heritage Building List



Level 1 - Heritage Buildings
From Top to Bottom: Nagle Hall, 1909; Scoates Hall, 1932; All Faiths Chapel, 1957

Level 1

Heritage Buildings

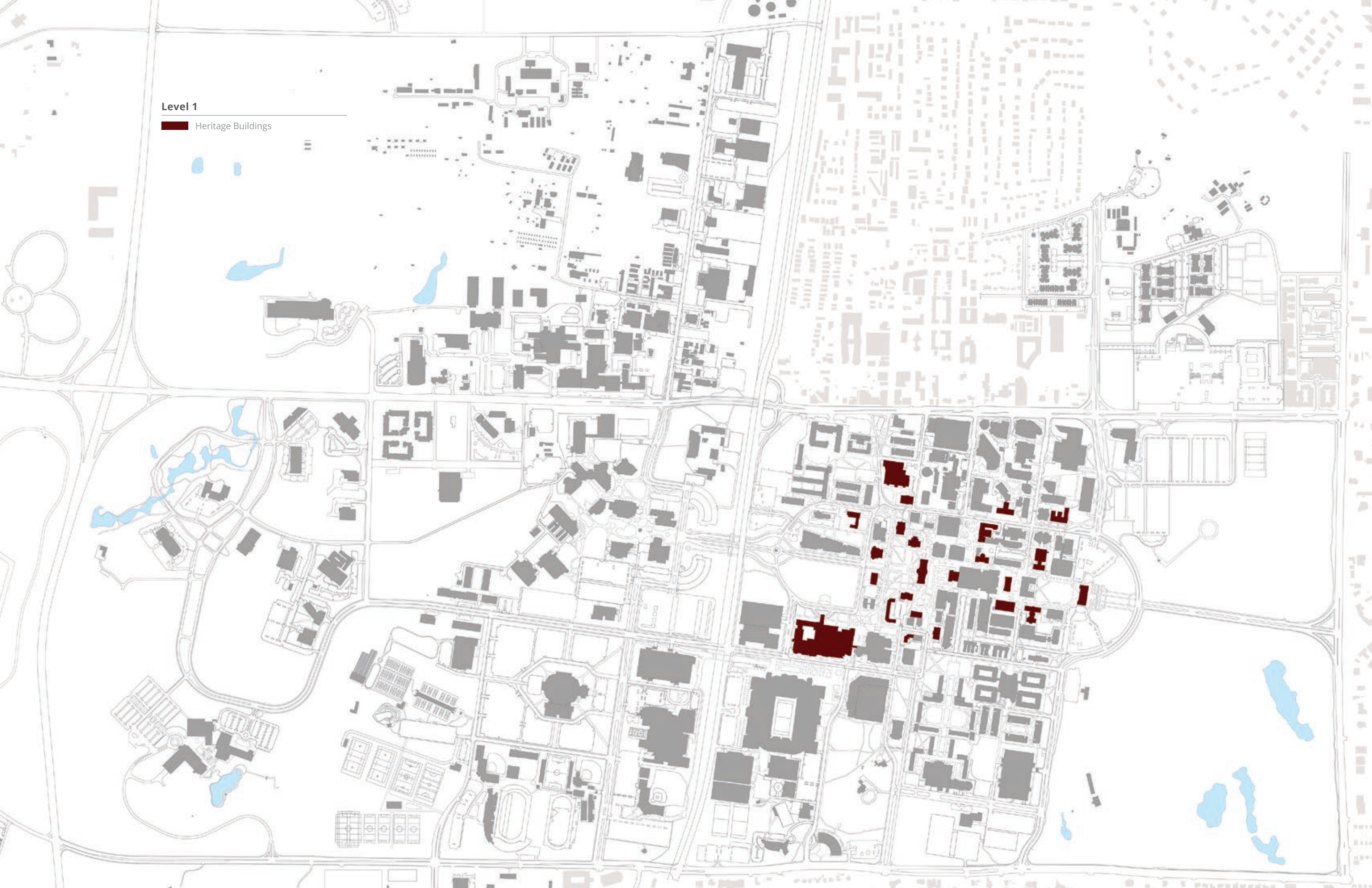

Level 2 — Historic Building

Level 2 - Historic Buildings are recognized as assets above and beyond their utilitarian value through architectural or cultural significance and design integrity. Level 2 buildings are typically those structures that retain the majority of their original exteriors and interiors but have experienced minor alterations in the past that do not compromise their historic integrity. While they are not classified as Level 1 - Heritage Buildings, these buildings contribute to the understanding of campus development and history. With time, the value of these structures as part of the campus and their importance as representatives of their respective building periods will increase and these structures may become Level 1 buildings.

The University is committed to maintaining and preserving the character defining features of these structures unless there is a compelling reason to do otherwise. The character defining features of the exterior and interior are to be preserved or restored. Additions or alterations are to be carefully considered and shall comply with the Heritage Conservation Guidelines contained in this chapter.



Walton Hall, 1931

Current Building Name	Bldg #	Date
Fermier Hall	0482	1919
Walton Hall	0422	1931
Spence Hall - Dorm 1	0400	1938
Fountain Hall - Dorm 4	0403	1938
Kiest Hall - Dorm 2	0401	1938
Briggs Hall - Dorm 3	0402	1938
Gainer Hall - Dorm 5	0404	1938
Lacy Hall - Dorm 6	0405	1938
Leonard Hall - Dorm 7	0406	1938
Harrell Hall - Dorm 8	0407	1938
Whitely Hall - Dorm 9	0408	1938
White Hall - Dorm 10	0409	1938
Harrington Hall - Dorm 11	0410	1938
Utay Hall - Dorm 12	0411	1938
Duncan Dining Hall	0450	1940
Biological Sciences Building East	0467	1950
Anthropology Building	0477	1952
Heep Laboratory Building	0511	1957
Henderson Hall	0425	1958
Doherty Building	0513	1960
Nuclear Science Center	1095	1961
TVMC Wildlife and Exotic Animals	4542	c. 1920

Level 2 — Historic Building List



Level 2 - Historic Buildings
From Top to Bottom: Heep Laboratory Building, 1957; Doherty Building, 1960; Corps of Cadets Quad and Dormitories, 1938;

Level 2

Historic Buildings



Level 3 — Secondary Historic Buildings

Level 3 - Secondary Historic Buildings, in their current condition, continue to contribute to understanding of the campus development and history. Planning for these buildings will include continued maintenance and preservation except where the building is found to be impractical for adaptive use, excessively costly to repair or where the removal substantially benefits the future development of the University. Additions or alterations are to be carefully considered and shall comply with the Heritage Conservation Guidelines contained in this chapter.



Architecture Building C, 1963

Current Building Name	Bldg #	Date
Thompson Hall	0483	1921
Utilities and Energy Services Central Office	0496	1940
Hotard Hall	0424	1941
Moses Hall	0412	1942
Davis-Gary Hall	0415	1942
Entomology Research Laboratory	0815	1949
Engineering Activities Building B	0459	1949
Engineering Activities Building C	0458	1954
Engineering Activities Building A	0460	1954
Computing Services Center	0516	1959
Peterson Building	0444	1963
Architecture Building C	0432	1963
Hughes Hall	0426	1966
Fowler Hall	0427	1966
Keathley Hall	0428	1966
Schuhmacher Hall	0430	1966
Teague Research Center	0445	1966
DPC Annex	0517	1966
Biological Sciences Building West	0449	1967

Level 3 — Secondary Historic Building List



Level 3 - Secondary Historic Buildings
From Top to Bottom: Thompson Hall, 1921; Utilities and Energy Services Central Office, 1940; Biological Sciences Building West, 1967

Level 3

Secondary Historic Buildings

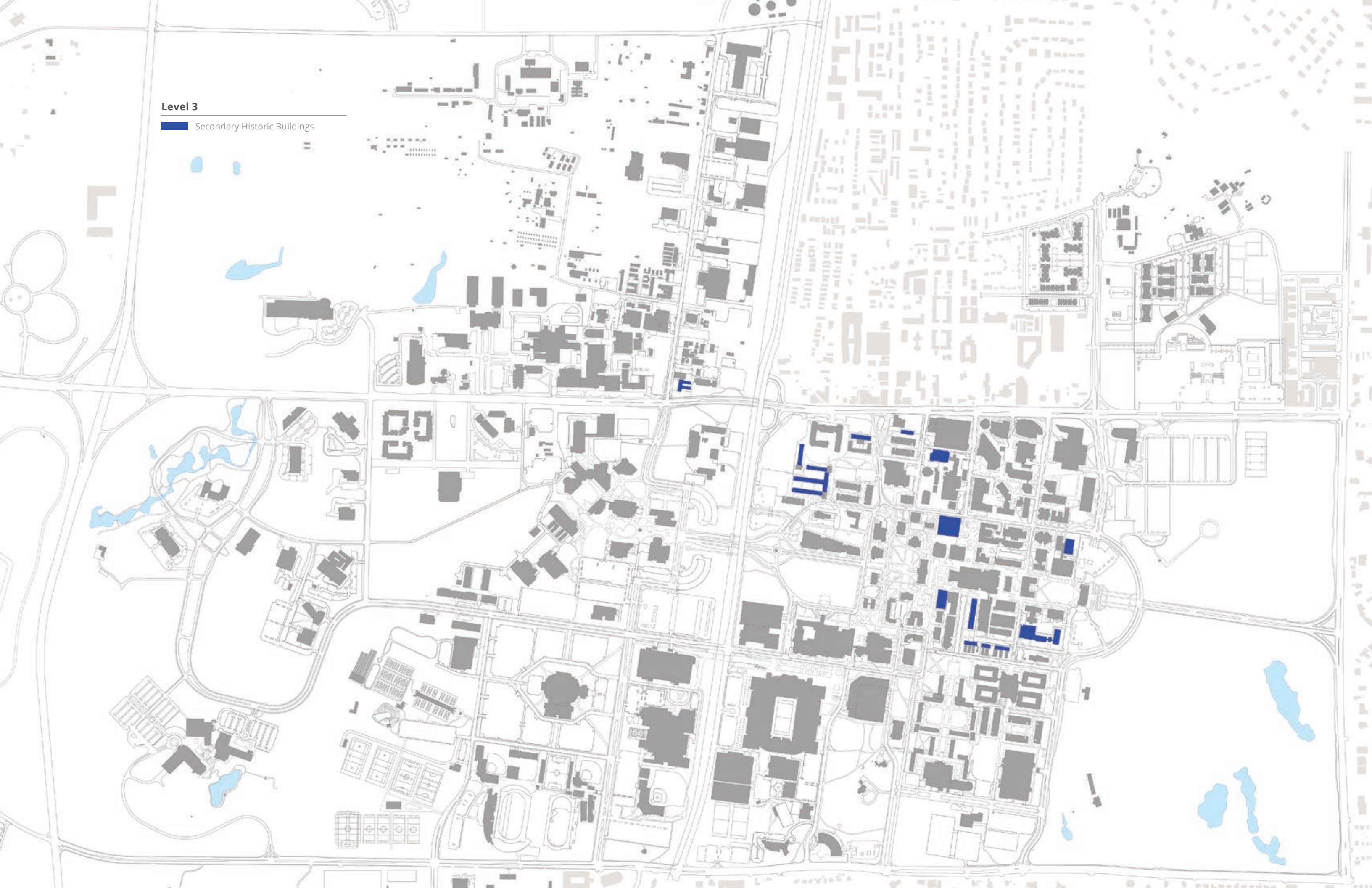

Level 4 — Buildings 50 years and older

Level 4 – Buildings 50 years or older, are structures that are at least 50 years old and have experienced significant alterations in the past that compromise their historic integrity. These buildings cannot be reasonably repaired or restored or they do not contribute to the understanding of campus development and history.



Heaton Hall, 1926

Current Building Name	Bldg #	Date
Central Utility Plant	0498	1915
Heaton Hall	0481	1926
Horticulture Shop	0799	1926
TAES Annex Building	0457	1933
Horticulture Implement Shed - B	0798	1936
Grounds Maintenance Implement Shed	0824	1937
Vice President's Residence	0630	1939
Horticulture Implement Shed - A	0797	1941
Farm Service Storage 2	1005	1946
Grounds Maintenance Office Shop Storage	0829	1947
Agronomy Field Laboratory	0954	1952
Soil Testing Laboratory	0806	1954
Engineering Innovation Center	0499	1955
Adriance Laboratory	0510	1955
Chemistry Chemical Storage	0715	1955
TVMC Small Animal Building	0880	1955
Farm Service Implement #1	1001	1955
Farm Service Implement #2	1002	1955
Farm Service Shop	1003	1955
TVMC Barn No 2	0943	1957
TVMC Barn No 3	1008	1957
CUSE Chemistry	0861	1958
Butler Building	0862	1958
Horticulture Shop and Garage	1011	1958
TVMC Small Animal Research Building	1010	1959
Nursery Floral Field Laboratory	1027	1959
Munnerlyn Astronomy and Space Sciences Engineering	0514	1960
Agronomy Implement Storage	1029	1960
AG Engineering Research Laboratory and Shop	1030	1960
Perennial Grass Breeding and Genetics	0956	1962
Architecture Building B	0359	1963
AG Engineering Power and Machinery Building	1034	1963

Level 4 — Buildings 50 years and older

Current Building Name	Bldg. #	Date
Forage and Turf Greenhouse	1054	1964
Soil and Crop Science Greenhouse	1057	1964
Civilian Lounge A2	1412	1964
Civilian Lounge A3	1415	1964
Civilian Lounge A1	1427	1964
Civilian Lounge C1	1430	1964
President's Residence	0634	1965
USDA Greenhouse 1	1045	1965
Weed Science Field Laboratory	1052	1965
Soil and Crop Science Greenhouse	1056	1965
Soil and Crop Science Greenhouse	1058	1965
Soil and Crop Science Greenhouse	1059	1965
CUSE Shop and Storage	1168	1965
Luedecke Building	0434	1966
Greenhouse Small Grains	1060	1966
Soil and Crop Science Dry Processing	1065	1966
Cotton Ginning Laboratory	1066	1966
Reed-McDonald Building	0436	1967
Greenhouse Cotton Taxonomy	1063	1967
Greenhouse	1064	1967
CUSE Toxicology Hut	1169	1967
TVMC Caged Animals	0989	1968
VMP Shop	0991	1968
Vivarium III	1020	1968
Golf Course Clubhouse	0672	1969
Grounds Maintenance Greenhouse	0831	1969
Cardiovascular Pathology Laboratory	1040	1969
Texas Veterinary Medicine Diagnostic Laboratory	1041	1969
Compressor House	0632	1970
Grounds Maintenance Storage	0742	1970
TVMC Experimental Animal Building	0992	1970
USDA Greenhouse 2	1049	1970

Level 4

Buildings 50 years and older

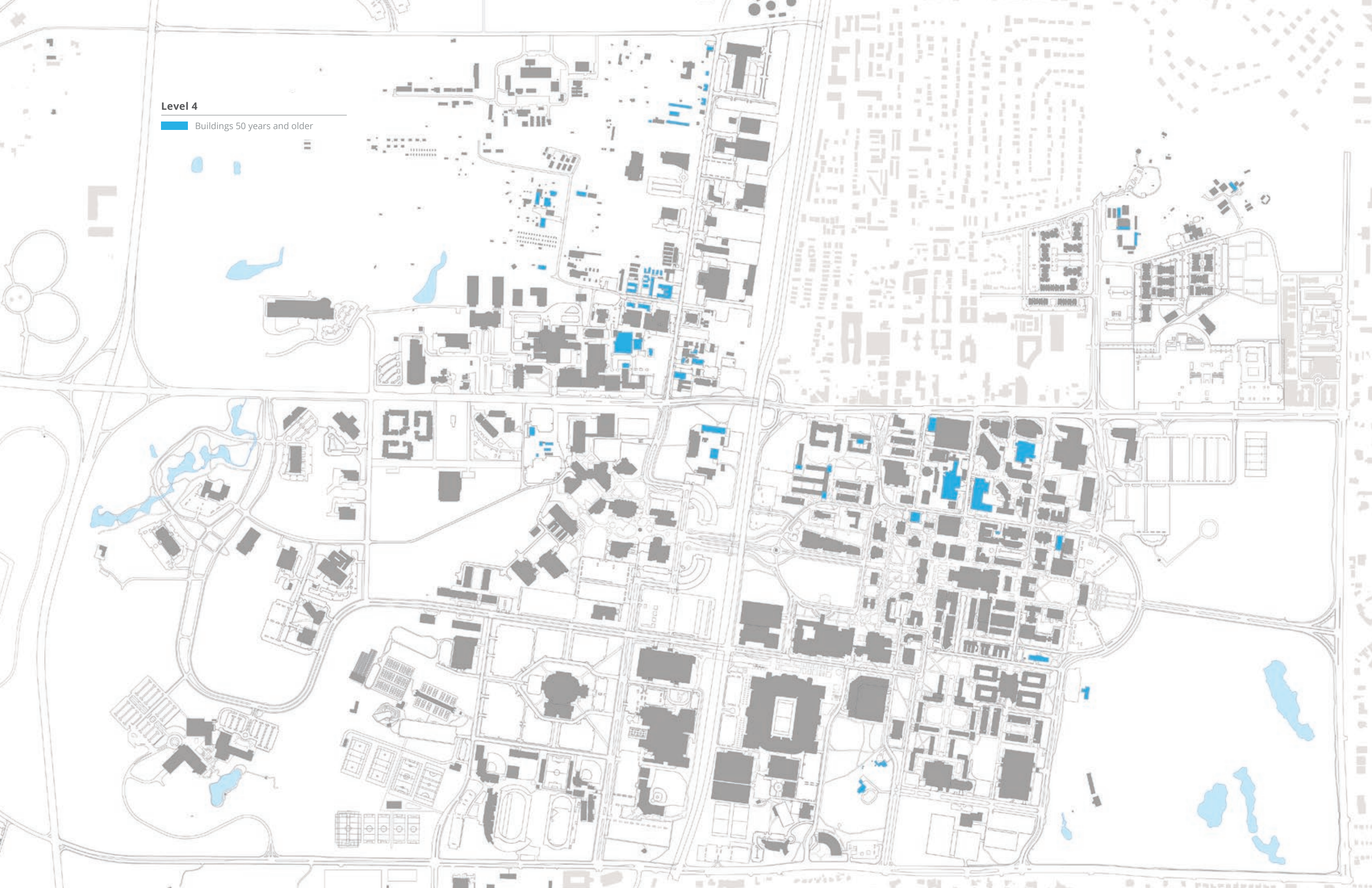

Watch List

The Watch List is meant to address buildings constructed between 1970 and 1975 that have not been evaluated for eligibility, but that will soon need to be addressed. Information is provided to enable the University to consider these buildings in the future, at which time they shall be considered for eligibility and categorized into the designation levels, as appropriate based on significance to the University and contribution to the character of campus. Likewise, buildings built after 1975 will need to be evaluated and categorized in the same manner. Evaluation and categorization shall take place every five years, beginning five years from the conclusion of this master plan.

Commons Residence Halls, 1972-1975

The complex consists of four rectangular dormitories, each with an interior courtyard. The buildings are located at the corners of a central communal building renovated in 2016. The exterior consists of tan brick. All building elevations are similar, with little ornamentation and vertical bands of narrow windows. Two of the dormitories were first built for women.

Harrington Education Center, 1972-1974

The building is an eight-story rectangular tower. A smaller adjacent lecture room building was constructed during this period and has a similar design. The exterior tower consists of tan brick with a pitched copper roof. Projecting vertical brick bands extend down the full length of the building forming a colonnade at the recessed first and second floor. The building is named after distinguished alumnus, Marion T. Harrington, class of 1922, who served in dual capacities of President and Chancellor.

Moore Communications Center, 1972

The building consists of a lower rectangular volume and two taller square volumes. The exterior consists of tan brick. The first floor entrance is elevated above street level and articulated with a masonry wall that projects past the main façade with few windows. The building was built to house campus public radio, KAMU-FM and television station, KAMU-TV.

Rudder Tower, 1973

The most recognizable feature of the complex is the eleven-story rectangular tower. The exterior consists of tan and cream colored precast concrete panels. The building is typical of the Brutalist style of the period. Building elevations are similar on all sides, with little ornamentation and a central bay of projecting windows. Named for General James Earl Rudder class of 1932, sixteenth president of Texas A&M University, third president of the Texas A&M University System.

Oceanography and Meteorology Building, 1973

The building is a fifteen-story rectangular tower with a weather observation tower. This is the tallest building on campus. The exterior consists of cream colored limestone veneer. Building elevations are similar on all sides, with projecting vertical bands and building cornice. Narrow horizontal bands of windows are on each elevation.

Beutel Health Center, 1974

The two-story rectangular shaped structure consists of tan brick and precast. The building is typical of the Brutalist style of the period. The facades are similar on all sides with projecting precast vertical triangular fins and roof edge and narrow horizontal bands of windows. Named for Dr. A.P. Beutel, who was a member of the Texas A&M University Board of Regents.



Watch List (1970-1975 Buildings)
From Top to Bottom: Rudder Tower,
Harrington Education Center,
Oceanography and Meteorology
Building

Watch List

1970-1975 Buildings

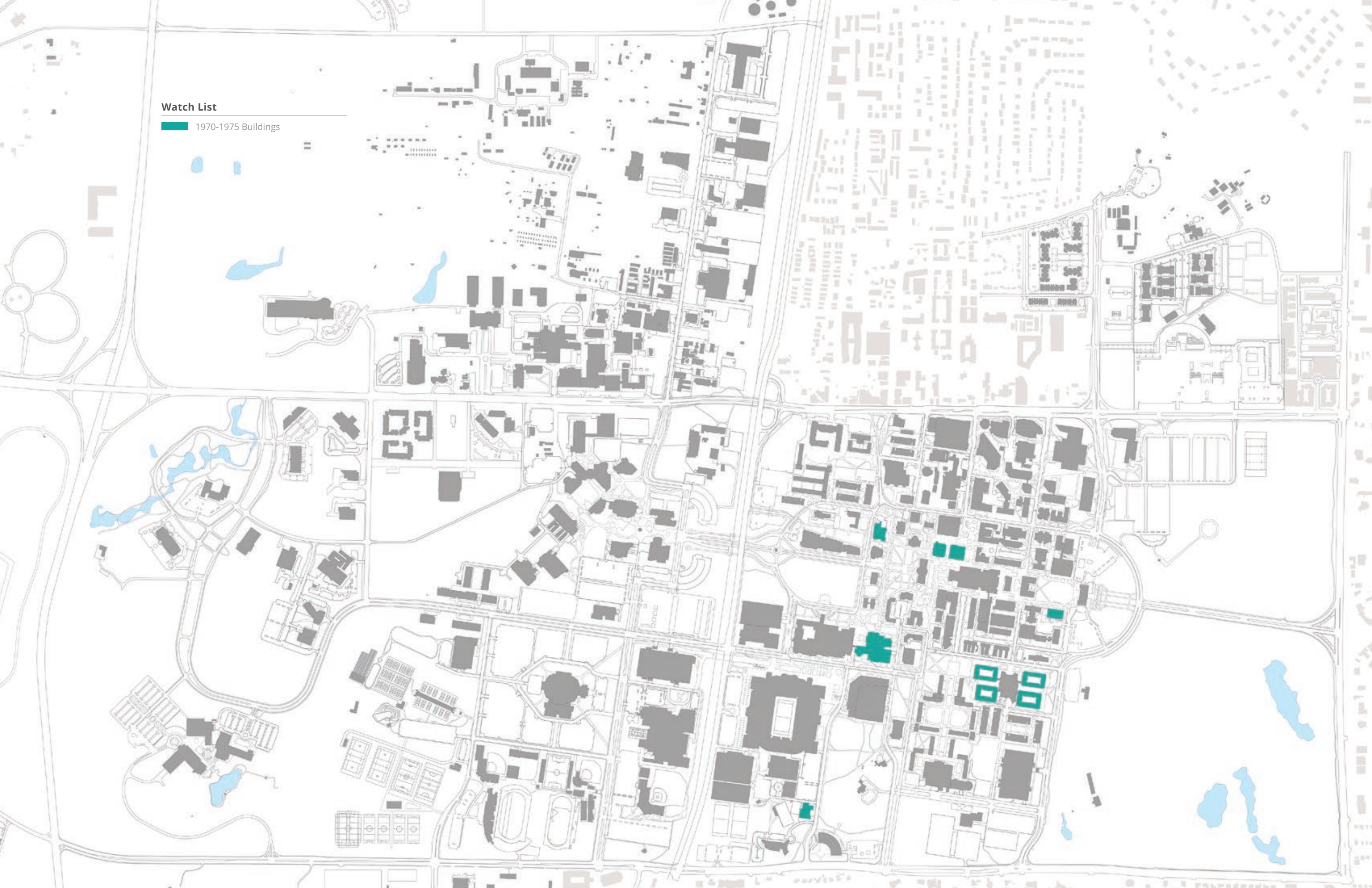

Historic Campus Resources

The campus developed on a roughly symmetrical arrangement of streets and open spaces giving form and organization to the campus. The result created a series of public spaces with a harmonious relationship between streets, open spaces and buildings. With time, vistas of campus and significant open spaces were defined as the campus developed. These spaces, or sequence of outdoor rooms, strengthen the three-dimensional form of the campus providing definition, character and context for both the historic buildings and new construction. Some of these open spaces have become symbolic of the culture and history of the University itself, like the Academic Plaza, the site of traditions and countless University events.

Connected by streets, paths and vistas, the character of these spaces is defined by building facades and height, landscapes and site features. These resources provided the framework for the development of campus; unfortunately in many instances these connectors have been broken and have created disjointed spaces. Open spaces, vistas, circulation routes and site features are equally as important as the buildings in the composition of the campus environment. Careful consideration to the preservation of the Historic Campus Resources is critical in maintaining the unique character and identity of campus.

Historic Campus Resources include outdoor spaces, site features, circulation paths and vistas. These Historic Campus Resources were not classified into the designation levels like the historic buildings because of the nature of these resources. The University shall strive to preserve and maintain these historic resources throughout campus. These resources contribute equally to the character of campus and contribute to the overall experience of attending or visiting campus.

Military Walk, Historic Photograph - 1920,
Cushing Memorial Library and Archives





Outdoor Spaces

Outdoor public spaces are similar to outdoor rooms; they were planned or formed over time through the development of campus. The character of these spaces is comprised of adjoining building facades, building heights and scale. Types of open spaces vary in size and consist of plazas with hardscapes, formal lawns or open greenspace. Examples of Outdoor Spaces include the Academic Plaza, Simpson Drill Field, and the Jack K. Williams lawn.



Simpson Drill Field



J.K. Williams Administration Lawn



Open Space Adjacent to Psychology Building



Academic Plaza



Chemistry Plaza



View Corridors (Vistas)

Vistas are a series of outdoor public spaces or view corridors through campus. The vistas were planned or created over time as adjoining buildings and outdoor spaces were developed or buildings constructed. These view corridors through campus vary in size and character, often a monumental building as a focal point or a sweeping view of campus. They are defined by adjacent building facades and heights, tree allees or a sequence of outdoor rooms. Examples of Vistas include Old and New Main Drives, and Military Walk.

The Bonfire Memorial is not a historic vista because it is less than 50 years old. However, it has substantial cultural significance as the site of a campus tragedy and the former site of a major campus tradition. The memorial will inevitably become designated as a Level 1 resource when it becomes 50 years old.



New Main Drive



Academic Building and Plaza



Military Walk

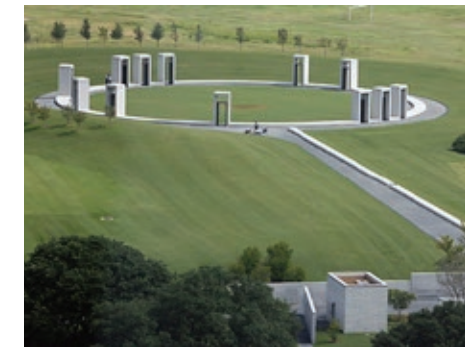

Bonfire Memorial



Circulation Routes

The historic circulation routes provided a framework to organize the built environment. These routes are a result of early master plan efforts to make connections between the buildings and outdoor spaces. Several of the routes established some of the most significant campus vistas and have long standing connections to student life. Examples of Circulation Routes include Bizzell Street, Ross Street, and Joe Routh Boulevard.



Evans Library Mall



Ross Street



Houston Street

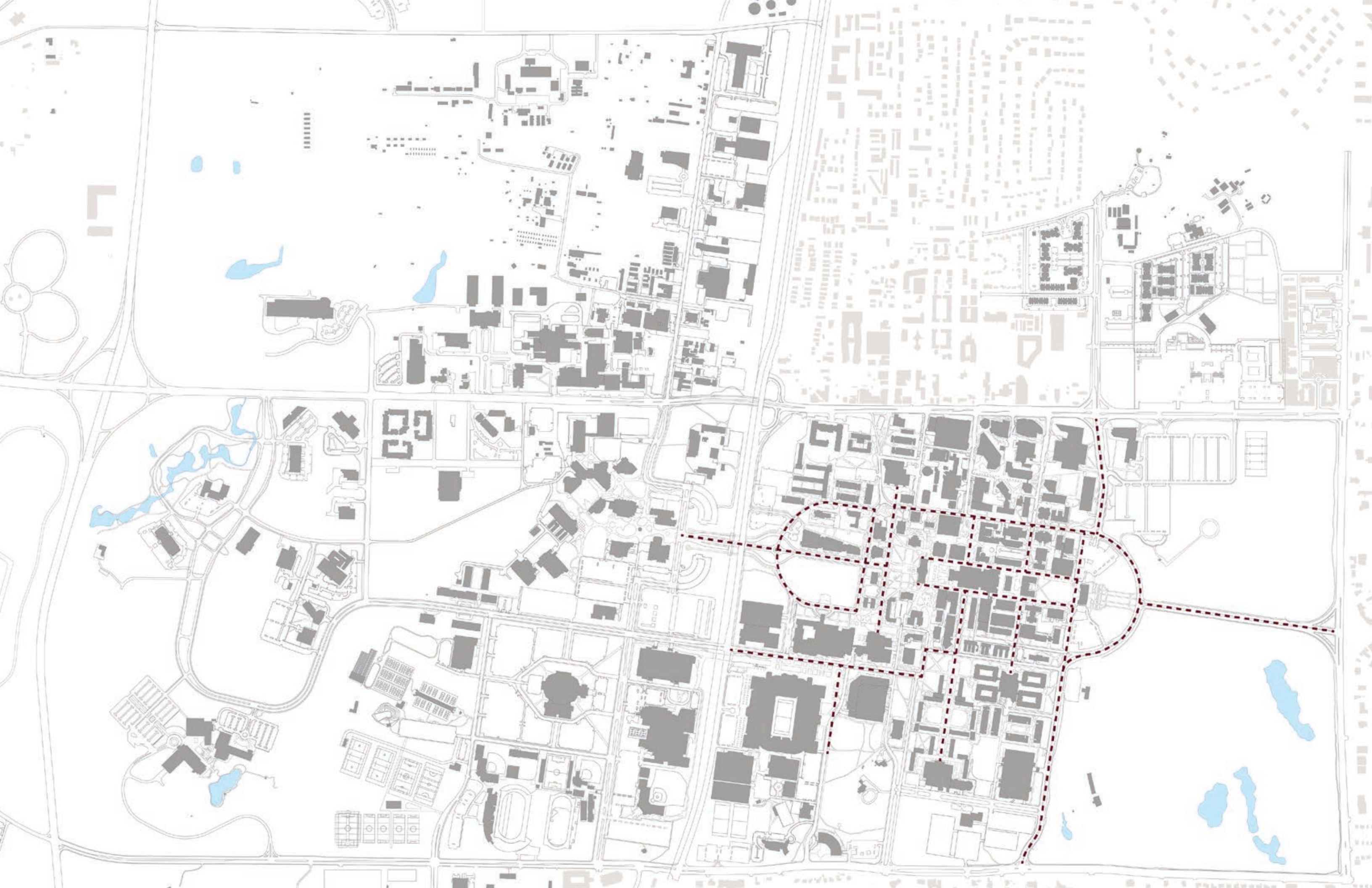

Site Features

The character of outdoor spaces, vistas and circulation routes are not only defined by the buildings and trees that at its edges but also by objects within the spaces. This diverse array of site features varies greatly in scale and type. Examples of Site Features include memorial trees, cast stone site furniture, and cast stone light fixtures.



J.K. Williams Administration Building Flag Pole Skirt



Hensel Park Pavilion



Cast Stone Bench



Light Post



Street Sign Post



Memorial Student Center, Historic Photograph - 1966, Cushing Memorial Library and Archives

RESOURCE STEWARDSHIP

Texas A&M University is the steward of historic resources that reflect the proud history and traditions of the institution and a legacy of academic excellence and selfless service. The University has distinguished itself through excellence in teaching, research and innovation; the built environment shall reflect the quality of the people and programs that make Aggieland home. Sensitive stewardship of these historic resources contributes to a viable, healthy campus by reinforcing the existing character and accommodating change.

As the University continues to grow and expand it will be required to accommodate new development with infill buildings or additions to existing buildings. New technologies, the replacement of aging building systems and routine maintenance are other considerations that would affect the character of the historic resources.

The principles and guidelines contained in this chapter have been developed to assist the University in planning for campus development and the ongoing use, repair and maintenance of these historic resources. These principles and guidelines are written to be consistent with federal and state – the Texas Historical Commission – standards for treatments to historic properties.

Chapter 7 - Heritage Conservation, replaces the previous 2008 Heritage Building Guidelines. This chapter was written in the spirit of and incorporated applicable content from the previous guidelines.

Academic Plaza, Historic Photograph - 1916,
Cushing Memorial Library and Archives ▶



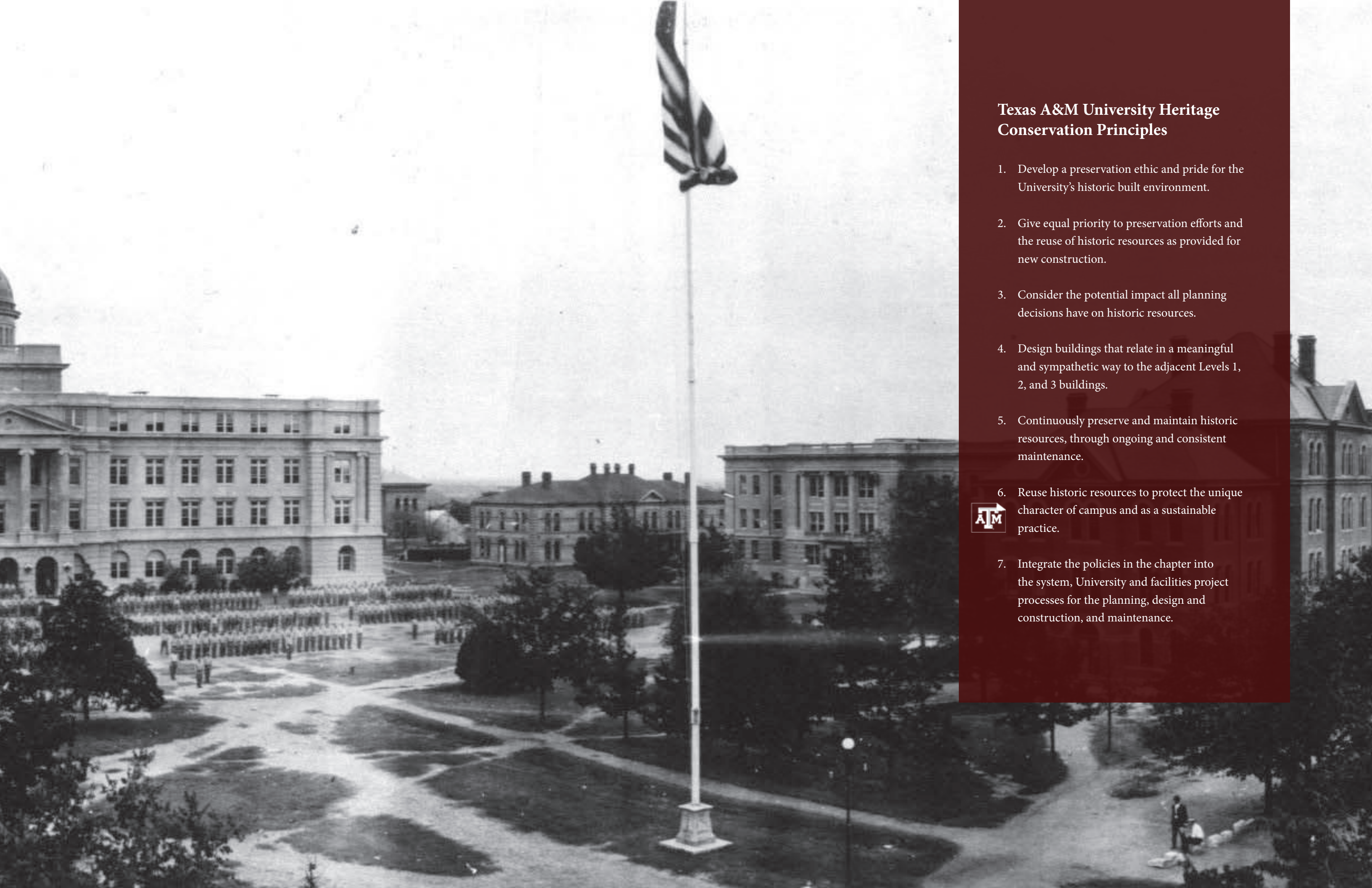

Texas A&M University Heritage Conservation Principles

1. Develop a preservation ethic and pride for the University's historic built environment.
2. Give equal priority to preservation efforts and the reuse of historic resources as provided for new construction.
3. Consider the potential impact all planning decisions have on historic resources.
4. Design buildings that relate in a meaningful and sympathetic way to the adjacent Levels 1, 2, and 3 buildings.
5. Continuously preserve and maintain historic resources, through ongoing and consistent maintenance.
6. Reuse historic resources to protect the unique character of campus and as a sustainable practice.
7. Integrate the policies in the chapter into the system, University and facilities project processes for the planning, design and construction, and maintenance.



HERITAGE CONSERVATION GUIDELINES

The following guidelines are supported by the aforementioned principles. The principles set the vision for the preservation of campus buildings and open spaces, while the guidelines outline processes, policies and actions surrounding the conservation of historic resources. Multiple principles are addressed within each guideline.



Academic Building Dome

Preservation Ethic and Historic Resource Awareness

Developing a preservation ethic and raising awareness of the historic resources on campus, makes it easier to partner with building occupants to adapt to changing needs while reinforcing the unique character of campus.

- Designate a single point of contact with expertise and training, within the Office of the University Architect, to serve as an advocate and institutional resource to coordinate preservation activities on campus.
- Re-evaluate designated buildings every five years to elevate buildings as they mature and become more respected.
- Increase awareness of the value of the University's historic resources through interpretation signage, audio tours of Level 1 and 2 buildings including Historic Campus Resources, and dissemination of information about buildings through a website.
- Promote continued research and study of the Level 1 and 2 buildings and Historic Campus Resources.
- Continue to fund small preservation projects to raise awareness for the quality of buildings on campus. Examples of recent past projects include significant public spaces and lecture rooms.
- Install Level 1 designation plaques on all buildings without Campus Remembered plaques. The Design Review sub-council shall approve the designation plaque prior to installation. The location, design, material and content shall be consistent with The Campus Remembered plaque. This effort shall continue as Level 2 buildings are evaluated and elevated to Level 1 Heritage Buildings.
- Increase awareness of building designation levels and the character defining features of the building with each Building proctor.
- Utilize the Center for Heritage Conservation as a resource in promoting campus preservation efforts and to assist with documentation and campus research.



Campus Remembered Plaque - Scoates



Campus Remembered Plaque - Halbouty

Planning for Historic Resources

By considering historic resources in the early stages of the project, planners and architects have the opportunity to coordinate existing resources with desired program requirements to develop a successful project. Through this coordination, historic buildings can adapt to the changing needs of the occupants without the loss or destruction of historic fabric.

- Office of the University Architect shall be contacted prior to project feasibility planning process and be fully integrated throughout the project planning, design and construction.
- The compatibility of proposed uses shall be determined by the Council for the Built Environment (CBE) with consultation of a Preservation Architect.
- Design Review sub-council (DRsc) of the CBE purpose is to monitor and ensure that all projects comply with the intent of the Campus Master Plan and to ensure existing buildings are enhanced in a manner consistent with the guidelines. The DRsc shall be engaged throughout the project at key intervals during planning/design process and construction.

Project Feasibility Planning Process

Historic Structure Reports or Preservation Guidelines shall be performed on Level 1 and 2 buildings and Outdoor Spaces prior to conceptual project feasibility planning process.

Actions that trigger Historic Structures Reports and Preservation Guidelines:

- **Historic Structures Reports**
 - When proposed cumulative work over a 2 year period for a building is estimated to be \$10 million or greater.

- **Preservation Guidelines**

- Council of the Built Environment:
 - Re-assignment of a building or a portion of a building is proposed.
 - Alterations or an addition is proposed.
- Office of the Vice President for Facilities
 - Repairs or renovations to the exterior or interior of the building or Outdoor Space are proposed.

Outdoor Spaces

Outdoor Spaces provide the context for historic buildings and contribute greatly to the character of the campus and should be considered during the planning process. Designated Outdoor Spaces (See Chapter 07 Page XX) vary in size and consist of plazas, formal lawns or open greenspace. Reports for these spaces will vary greatly based on the type and size of Outdoor Space but should follow the same format and include relevant information from the report outlines listed in this section.

Other planning considerations

- When changes in use are needed, programming shall emphasize uses that require the least drastic changes to the buildings. This enables continued use of the building and is more cost efficient.
- The impact on historic buildings from new construction, additions, and renovation shall be factored into the feasibility of the project.
- Internally or externally generated planning documents shall fully integrate the Heritage Conservation Guidelines.
- As the campus landscaping is replaced, carefully consider new locations so as not to obscure the character defining features of buildings.

Historic Structures Report

When proposed cumulative work over a 2 year period for a building is estimated to be \$10 million or greater, a Historic Structures Report (HSR) is to be completed by a qualified Preservation Architect or the Office of the University Architect. The creation of this report is to be funded as part of the overall project budget and should be established early in the process in order to establish priority levels in relation to the historic fabric of the buildings. As described in National Park Service (NPS) Preservation Brief 43, an HSR provides documentary, graphic, and physical information about a building's history and existing condition as a readily accessible reference document for the management of a historic building. All NPS Preservation Briefs can be found at www.NPS.gov. The format for each report shall be consistent and follow the following outline for content, nomenclature and organization.

- Executive Summary
 - Introduction
 - Study Summary
 - Project Data
- Part 1 – History
 - Historical Background and Context
 - Chronology of Development and Use
 - Preservation Zoning Diagrams
 - Exterior Character Defining Features
 - Interior Character Defining Features
 - Condition Assessment
- Part 2 – Treatment and Work Recommendations
 - Historic Preservation Objectives
 - Requirements for Work
 - Work Recommendations and Alternatives
 - Bibliography
 - Appendices
 - Historic and Current Photographs

- Supplemental Record of Work Performed (added after completion of project)
- Completion Report
- Technical Data (on work completed)

Preservation Zoning Diagrams shall reflect the prioritized spaces on floor plans of the building. The catalog of interior and exterior character defining features shall note priority levels. Building features and spaces shall be categorized into High Priority, Priority or not classified.

High Priority: Typically those spaces that are public, retain the majority of their original materials and features in reasonable or repairable condition, and provide value to one's understanding of the building's design, use or history.

Priority: Typically those spaces that are public or serve the primary building function, retain the majority of their original materials and features in reasonable or repairable condition, and provide value to one's understanding of the building's design, use or history.



Melbern Glasscock Building, Historic Photograph, Cushing Memorial Library and Archives

Preservation Guidelines

In smaller scaled projects such as: re-assignment of a building or a significant portion of a building, significant alterations such as an addition, or repairs or renovations to the exterior/interior of the building or outdoor Space, Preservation Guidelines are to be completed by a qualified Preservation Architect or the Office of the University Architect. The creation of these guidelines is to be funded as part of the overall project budget and should be established early in the process in order to establish priority levels in relation to the historic fabric of the buildings. Preservation Guidelines are a readily accessible reference document for the management of a historic building. The report includes a historic resource history, historic and current photographs, preservation zoning diagrams, and cataloging of exterior and interior historic features. The format of each report shall be consistent and follow the precedent established by earlier Preservation Guidelines for content, nomenclature and organization as noted below. Reference the previous Historic Structures Report for additional information regarding Preservation Zoning Diagrams.

- Executive Summary
 - Introduction
 - Study Summary
 - Project Data
- Part 1 - History
 - Historical Background and Context
 - Chronology of Development and Use
- Part 2 - Preservation Guidelines
 - Preservation Zoning Diagrams
 - Exterior Character Defining Features
 - Interior Character Defining Features
 - Historic and Current Photographs

Council of the Built Environment, Design Review Sub-Council

- The basis of the DRsc review will be the findings from the Historic Survey Report or Preservation Guidelines.
- The recommendation will be based on the appropriateness of the proposed actions, and specifically on the impact the proposed work will have on the integrity of the historic resource, the context in which the resource sits, and the long-term significance of the outcome.



Buildings that have Feasibility Studies Completed - From Top Left to Bottom Right: Academic Building, Animal Industries Building, Military Sciences Building, and Nagle Hall

Design and Construction

Antiquities Code of Texas, Section 191.098. Notification of Alteration or Demolition of Possible Landmark.

The language in this section is quoted from the Antiquities Code of Texas.

- A state agency may not alter, renovate, or demolish a building possessed by the state that was constructed at least 50 years before the alteration, renovation, or demolition and that has not been designated a landmark by the committee, without notifying the committee of the proposed alteration, renovation, or demolition not later than the 60th day before the day on which the agency begins the alteration, renovation, or demolition.
- After receipt of the notice the committee may waive the waiting period; however, if the committee institutes proceedings to determine whether the building is a state archeological landmark under Section 191.092 of the code not later than the 60th day after the day on which the notice is received by the committee, the agency shall obtain a permit from the committee before beginning an alteration, renovation, or demolition of the building during the time that the committee's proceedings are pending.
- Should the committee fail to provide a substantive response within 60 days to a request for a review of project plans, application for permit, draft report

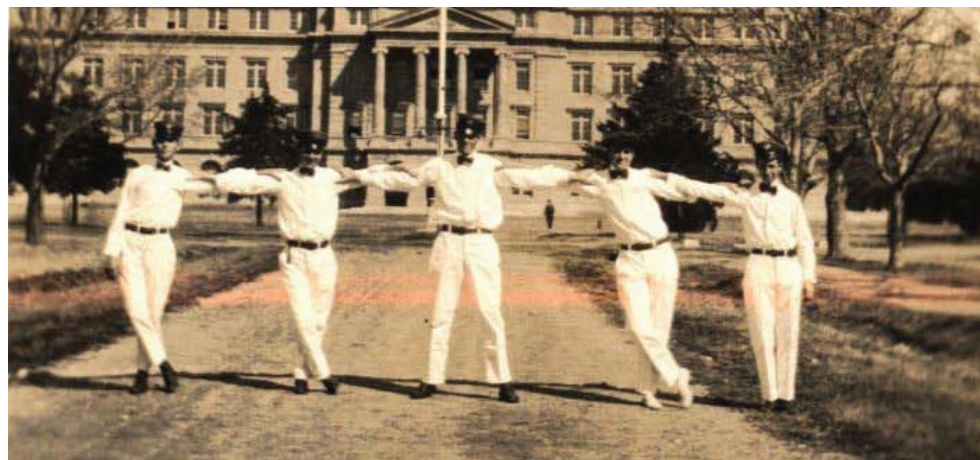

Academic Building, Historic Photograph, Cushing Memorial Library and Archives

review, or other business required under the Antiquities Code, the applicant may proceed without further reference to the committee.

Selection of A/E/C team

- Qualified Preservation Architect/Preservation Landscape Architect to be involved in project design team for Level 1 and 2 buildings and Outdoor Spaces.
 - Shall have an individual assigned to the project who has preservation architectural training or equivalent five years experience in preservation specialty.
 - Firm shall demonstrate commendable design work in the preservation specialty and buildings similar with the following qualifications; project name, location, size, age, cost, type of construction, services provided, color photographs, and client contact.
 - These qualifications for demonstrated commendable work shall be incorporated into the System, University and facilities services selection requirements.
- Qualified Preservation Contractor to be involved for Level 1 and 2 buildings and Outdoor Spaces.
 - Shall have an individual assigned to the project who has preservation construction training or equivalent five years experience in preservation specialty.
 - Firm shall demonstrate commendable design work in the preservation specialty and buildings similar with the following qualifications; project name, location, size, age, cost, type of construction, services provided, color photographs, and client contact.
 - These qualifications for demonstrated commendable work shall be incorporated into the System, University and facilities services selection requirements.



Historic Photographs
From Top to Bottom: All Faiths Chapel;
Animal Industries Building; Nagle Hall,
Cushing Memorial Library and Archives

A/E Design Standards and Guidelines

As the steward of historic buildings and campus resources, nationally recognized standards created by the Secretary of the Interior for working with historic buildings provide a well-established and tested framework to successfully manage historic fabric. These standards along with National Park Service Preservation Briefs will be referenced for construction.

Secretary of the Interior Standards Summary

These standards or approaches, offer a philosophy for sensitively altering historic buildings and to provide a framework to assist in decision-making. They can be applied to a diverse range of other historic resources including open spaces, vistas, circulation routes and site features. The standards are not regulatory or prescriptive in nature but are intended to offer tools for the responsible stewardship of our nation's historic resources. The standards seek to ensure the protection of the qualities that maintain the character of the historic resource.

The United States Secretary of the Interior have developed four treatments of historic buildings, they are: preservation, rehabilitation, restoration and reconstruction.

The majority of the projects on this campus are anticipated to utilize the Rehabilitation treatment, however, it is common for projects to use a blend of preservation treatments to accomplish the project's programmatic goals. For example, the building might be rehabilitated with a missing character defining feature reconstructed or restored.

The language of the Standards for the Treatment of Historic Properties and The Ten Standards for Rehabilitation are quoted in full from the National Park Service website, [nps.gov/tps/standards.htm](https://www.nps.gov/tps/standards.htm)

Secretary of the Interior's Standards for the Treatment of Historic Properties

Preservation

Preservation is defined as the act or process of applying measures necessary to sustain the existing form, integrity, and materials of an historic property. Work, including preliminary measures to protect and stabilize the property, generally focuses upon the ongoing maintenance and repair of historic materials and features rather than extensive replacement and new construction. New exterior additions are not within the scope of this treatment; however, the limited and sensitive upgrading of mechanical, electrical, and plumbing systems and other code-required work to make properties functional is appropriate within a preservation project.

Rehabilitation

Rehabilitation is defined as the act or process of making possible a compatible use for a property through repair, alterations, and additions while preserving those portions or feature which convey its historical, cultural, or architectural values.

Restoration

Restoration is defined as the act or process of accurately depicting the form, features, and character of a property as it appeared at a particular period of time by means of the removal of features from other periods in its history and reconstruction of missing features from the restoration period. The limited and sensitive upgrading of mechanical, electrical, and plumbing systems and other code-required work to make properties functional is appropriate within a restoration project.

Reconstruction

Reconstruction is defined as the act or process of depicting, by means of new construction, the form, features and detailing of a non-surviving site, landscape, building, structure, or object for the purpose of replicating its appearance at a specific period of time and in its historic location.

The Ten Standards for Rehabilitation:

These standards are interpreted by the National Park Service in various helpful illustrated and expanded standard guides. It is recommended that more detailed and illustrated guidelines be developed and tailored to the conditions on the campus of Texas A&M University.

1. A property will be used as it was historically or be given a new use that requires minimal change to its distinctive materials, features, spaces, and spatial relationships.
2. The historic character of a property will be retained and preserved. The removal of distinctive materials or alteration of features, spaces, and spatial relationships that characterize a property will be avoided.
3. Each property will be recognized as a physical record of its time, place, and use. Changes that create a false sense of historical development, such as adding conjectural features or elements from other historic properties, will not be undertaken.
4. Changes to a property that have acquired historic significance in their own right will be retained and preserved.
5. Distinctive materials, features, finishes, and construction techniques or examples of craftsmanship that characterize a property will be preserved.
6. Deteriorated historic features will be repaired rather than replaced. Where the severity of deterioration requires replacement of a distinctive feature, the new feature will match the old in design, color, texture, and, where possible, materials. Replacement of missing features will be substantiated by documentary and physical evidence.
7. Chemical or physical treatments, if appropriate, will be undertaken using the gentlest means possible. Treatments that cause damage to historic materials will not be used.
8. Archaeological resources will be protected and preserved in place. If such resources must be disturbed, mitigation measures will be undertaken.
9. New additions, exterior alterations, or related new construction will not destroy historic materials, features, and spatial relationships that characterize the property. The new work will be differentiated from the old and will be compatible with the historic materials, features, size, scale and proportion, and massing to protect the integrity of the property and its environment.
10. New additions and adjacent or related new construction will be undertaken in such a manner that, if removed in the future, the essential form and integrity of the historic property and its environment would be unimpaired.



Historic Building Details
From Top to Bottom: Scoates Hall
Exterior Detail, Scoates Hall Lighting
Fixture, Scoates Hall Ceiling Detail



Post Construction

Maintenance

Maintenance can be one of the most significant agents for loss of historic resources either through lack of maintenance or over zealous or insensitive practices. The cumulative effects of routine maintenance and minor alterations shall be considered as seriously as major rehabilitation and new construction.

- Repair over replacement when addressing deterioration of historic features, when it is necessary to replace historic features, in-kind materials shall be used to the extent possible.
- Develop maintenance manuals for custodial and maintenance staff to assist in the sensitive implementation of practices for routine maintenance of special finishes and materials of Levels 1, 2 and 3 Buildings. Many of the finishes and materials associated with historic resources cannot be repaired using standard modern practices or replacement materials.
- In addition to manuals, the training of all building proctors, maintenance and custodial staff shall include specific components on historic fabric.
- Utilize National Park Service Preservation Briefs for additional information for best practices when working with historic resources.

Record Keeping

Project records provide researchers and preservationist evidence of the building's evolution, clues to what might be original in the building and can help to determine corrective measures. Like layers of paint, complete project records provide insight into the layers of alterations historic resources endure. At a minimum, the project records should include, project closeout documents, final record drawings and final specifications.

Archiving

At the conclusion of a project a hardcopy of the Historic Structures Report or Preservation Guidelines should be deposited into Cushing Memorial Library and Archives.



Jack K. Williams Administration Building and Landscape, Historic Photograph, Cushing Memorial Library and Archives

Demolition

The University's heritage is reflected in the built environment and provides a tangible link to its past. The historic resources constitute a real connection to the heritage of the University as well as represent the investment of previous generations of Texans. The institution shall continually reinvest in these existing campus assets. Policies should recognize short-term facility needs do not justify the removal of historic structures or character defining features. However, where it has been found to be impractical for adaptive use or excessively costly to repair or alter, 60 days prior to removal; a completed Demolition Documentation Form shall be submitted to the Office of the University Architect. For Level 1 – Heritage and Level 2 – Historic buildings provide a Feasibility Study in addition to the Demolition Documentation Form.

Demolition Feasibility Study

Prior to making the decision to demolish a historic building or removing historic campus features due diligence shall be practiced by exploring options or alternatives that avoid or minimize negative impacts to these resources. A feasibility study to evaluate the potential for renovation efforts for an appropriate user shall be prepared by a qualified Preservation Architect or the Office of the University Architect prior to the initiation of the demolition process. Feasibility Studies are to be funded as part of the overall project budget and should be established early in the process in order to establish priority levels in relation to the historic fabric of the buildings. The format for the Feasibility Study shall be consistent and follow the following outline for content, nomenclature and organization.

- Executive Summary
 - Introduction
 - Study Summary
 - Building Removal Explanation

- Part 1 - Feasibility Study
 - Program of requirements
 - Evaluation of program requirements in historic building
- Part 2 - Written History or previous Historic Structures Report/Preservation Guidelines
 - Building's Historical Background and Context
 - Chronology of Development and Use
- Part 3 – Architectural Information
 - General Architectural Character Statement
 - Description of the Exterior
 - Description of the Interior
 - Historic and Current Photographs

Documentation

60 days prior to approval of demolition procurement documents, documentation of the building shall be concluded by completing the Texas A&M University Demolition Documentation Form.

Salvaged Materials

60 days prior to approval of demolition procurement documents, the University Architect will determine, after a review of the Demolition Feasibility Study and site visit, the architectural features of a building to be salvaged.

- Identify materials or architectural elements to be salvaged.
- Carefully remove salvaged items from building, label and store on crate or other protective container in fenced in area until the University finds appropriate location to reincorporate on main campus.
- Label each item with weather proof tag listing the demolished building, specific building feature and location from where the item was salvaged from on the building.





08

SIGNAGE AND WAYFINDING

Introduction
Graphic Standards
Signage Design Specifications
Nomenclature and Content
Sample Trips
Implementation Plan



The Signage & Wayfinding Plan embodies a cohesive spirit that ties together a diverse and culturally-rich community and underscores the University's physical relationship to the community.

Texas A&M University engaged Ayers Saint Gross to prepare a signage and wayfinding master plan in alignment with the University's 2017 Campus Master Plan. This chapter summarizes the strategic research and processes undergone and includes design drawings, descriptions, placement criteria, and messaging organization for Texas A&M University's proposed family of signs.

The information presented in this section represents the official Texas A&M University Signage & Wayfinding Master Plan that must be applied to all design projects undertaken by Texas A&M, on behalf of Texas A&M, or by others on Texas A&M property, unless otherwise specified by the Texas A&M University Council for the Built Environment (CBE) or Office of the University Architect. This document facilitates the signing of all Texas A&M locations and provides methods for ensuring consistency. The basic sign system enables campus visitors, student, and staff to identify Texas A&M locations, directs them effectively and safely to their destinations, and displays necessary information to negotiate safely through the environment while visually enhancing the campus aesthetic.

All signs must be submitted to Council for the Built Environment and Texas A&M Division of Marketing & Communications for approval. A survey and field study of conditions are necessary to determine messaging and sign placement. Texas A&M Graphic Services staff are available to discuss signage or graphic design projects prior to implementation and must be included in the review and sign-off process for every signage project.

The purpose of the Texas A&M University Signage & Wayfinding Master Plan is to deliver a methodology for implementing future signage at Texas A&M. The plan includes general recommendations for an integrated-system approach to vehicular and pedestrian directional signage and architectural lettering. This provides guidance for the creation of a comprehensive family of exterior wayfinding signs that ensure the University's mission and traditions are reflected in the identity and communication on the physical campus.

The plan is not meant to prescribe specific locations or messages, as these will vary as signage is implemented. Instead, this chapter establishes a framework for future development of signage and wayfinding that strengthens the identity and physical environment of Texas A&M's campus.

This chapter illustrates all sign families and details of each sign and can be used as a guideline in preparing individual sign packages that determine the necessary sign type, graphic layouts, and location criteria of signs to be installed. The chapter also includes sample tips to provide the University with examples of specific sign locations. These are meant to guide the University as implementation of the signage plan occurs over time.



Signage can educate campus users about Texas A&M's sustainability efforts. Opportunities include stormwater management systems, building features, and alternative energy sources.

Definition Of Terms

In order to have an effective Signage & Wayfinding Master Plan, it is important to understand the interrelated nature of signage, wayfinding, and audience impressions. The following descriptions provide a foundation for a plan that meets the needs of the Texas A&M University community.

Signage

The term signage describes the system of signs on campus that helps campus users navigate through the environment. The signage system is designed to address image, brand, and messaging needs. Signage design is successful when it carefully balances these aesthetic (image) and informational (message) needs. Signage performs both directional and identification functions. Directional signs provide navigational guidance and identity signs label destinations. For the purpose of this document, the planning team has distinguished two types of identity signs—freestanding and architectural—with the latter being a type of identifier applied directly to a building.

Wayfinding

The terms signage and wayfinding are often used together but are not interchangeable. While signage employs wayfinding messages, but it is only one tool within the program. Wayfinding is broader reaching; it is an action that occurs between a user and a place and it is affected by all visual and informational cues that help users understand where they are.

Beyond the physical setting, wayfinding for the University will begin well before a guest arrives. Tools such as the website, print collateral, and even personal conversations help audiences understand the totality of the campus as a place. These tools also establish the attitude of the campus and set the tone for a visitor's experience. The physical wayfinding system is expected to meet the same standard for quality interactions and information sharing. It should reinforce the institutional brand while delivering clear and simple navigational guidance.

Audience and Impressions

Signage & Wayfinding will enhance visitors' impressions of the University. These impressions include those that occur the first time a guest visits, and those that occur every time someone arrives on campus. There are three key audiences—first-time visitors, initiated users, and the broader community.

- **First-time Visitors**

Whether prospective students, parents, conference attendees, or visiting athletes—are the most dependent on signage to guide them. Their initial impression will be an introduction to the physical surroundings. A simple and straightforward message system will direct them to destinations, minimize confusion, and make them feel welcome.

- **Initiated Users**

This group includes current students, faculty, staff, and others who regularly spend time on campus. These users rely less on the navigational aspects; their relationship with signage is more about “place making.”

- **Broader Community**

As the University's neighbors, this group will be positively affected by the signage and wayfinding that promotes campus identity while integrating with the scale and aesthetic of the surrounding areas.

GRAPHIC STANDARDS

Signage is one of the first things a visitor sees when arriving on campus. It is an important opportunity to introduce and reinforce Texas A&M University's brand. Signage incorporating the University's Graphic Standards creates a sense of place for students, visitors, faculty, and staff. Texas A&M University's existing Graphic Standards are adapted to meet the legibility demands of signage while retaining the look and feel of the brand.

The Texas A&M University brand book was created in August 2016 in order to bring consistency to the communications of the University.



Texas A&M University Online Brand Guide - August 2016



Reville and Cadet on Game Day

Branded Elements

Primary and secondary vehicular directional signs shall display the full Texas A&M logo and wordmark (TAM Stack). These signs are not only a navigational tool for campus wayfinding, they also act to delineate the campus boundary and edges as well as mark the arrival to the campus.

The wordmark (TAM Wordmark) is used on the supplemental directional due to the size requirements of the sign panel.

The simplified logo (TAM logo) is used on the primary building identity signs to help reinforce a sense of campus identity and building arrival.

Typography

Tungsten is used for exterior sign messaging. This san-serif typeface has condensed attributes and open counters optimized for legibility on signage. The use of Tungsten is consistent with Texas A&M University's print brand standards.

Tungsten Medium is the primary font for all messages on wayfinding signs. Tungsten Light is used for secondary signage information. Tungsten Semibold is used on parking identity signage for lot numbers.



TAM Logo Box



TEXAS A&M
UNIVERSITY.

TAM Box Stack



TAM Primary Mark A

Tungsten Semibold - 75 pt. leading

ABCDEFGHIJKLMN**OP**QRSTUVWXYZ
abcdefghijklm**no**pqrstuvwxyz
1234567890

Tungsten Medium - 75 pt. leading

ABCDEFGHIJKLMN**OP**QRSTUVWXYZ
abcdefghijklm**no**pqrstuvwxyz
1234567890

Tungsten Light - 75 pt. leading

ABCDEFGHIJKLMN**OP**QRSTUVWXYZ
abcdefghijklm**no**pqrstuvwxyz
1234567890

Colors and Finishes

Sign colors and finishes are designed to feel appropriate to the campus. Exterior signs are heavily branded with Aggie Maroon and Gray components. White sign messages are designed to have the highest contrast relationship to the background panel.

An alternate stone material may be used on select primary vehicular directional signs located at the campus edge.

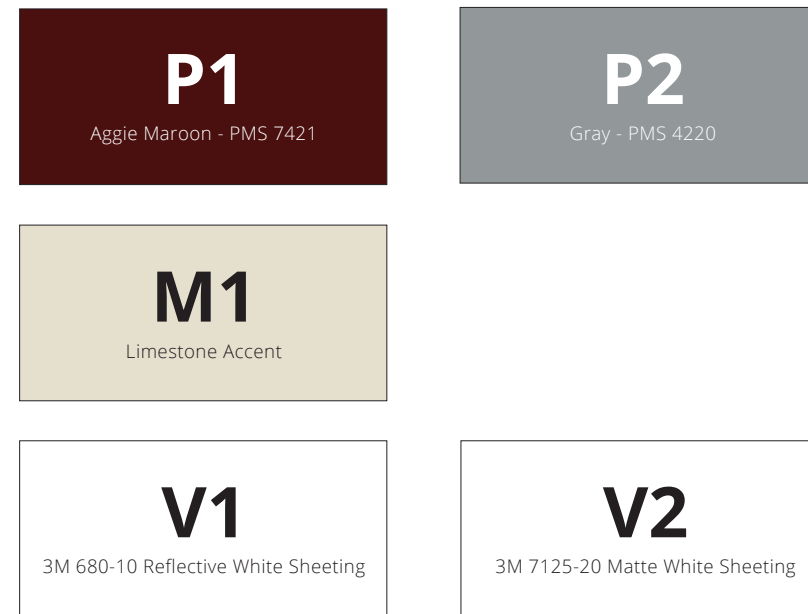

Arrows and Symbols

The arrows of the system were selected for their clear and contemporary attributes. Use of "straight-left" or "straight-right" arrows is not acceptable. Clear and recognizable symbols are used for parking, information signs, ADA signage and dining services.

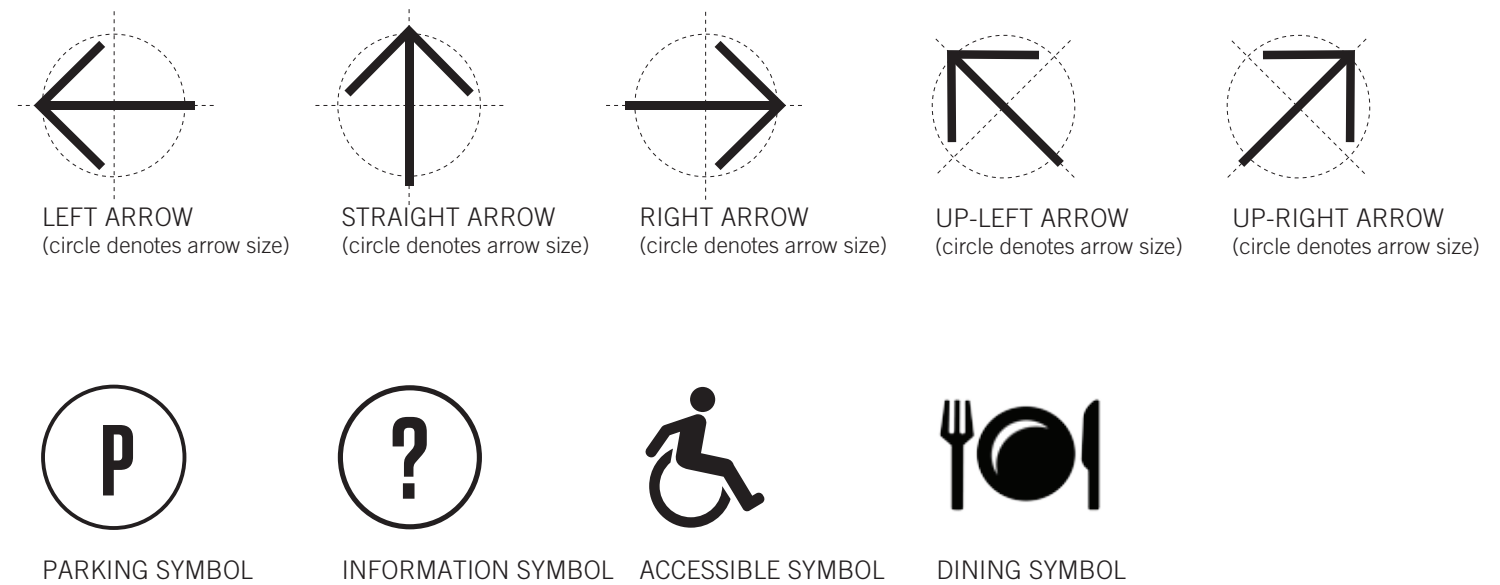

SIGNAGE DESIGN SPECIFICATIONS

A challenge with the existing signage at Texas A&M is the lack of hierarchy in location, content and message. The approach to the updated signage system is to create a clear hierarchy to illustrate a consistent and clean brand, message and wayfinding system for campus visitors and users. This begins at the perimeter of the campus, with improving gateway conditions to allow visitors to know that they have arrived to Texas A&M University. Secondly, some areas of the campus are geographically or programmatically separated and need visual identity signage as well.

To direct visitors into campus, large vehicular directional signage is placed along the perimeter as well to indicate where visitors should be accessing the campus closest to the parking area of their intended destination. Smaller vehicular signs interior to campus continue to direct visitors to visitor parking structures and lots. Once visitors have arrived at parking lots, signs are placed at entrances which indicate the lot number and restrictions.

Once on foot, pedestrians are encountered by pedestrian direction signs pointing them to key visitor designations such as the Memorial Student Center, Libraries, and the Student Recreation Center. These are supplemented with Building identification signs to allow visitors to know that they have finally arrived at their destination.

The sign types on the following pages of this section follow this hierarchy, seen in the chart to the left.

The materials and form present on campus are reflected in the signage design. The angled massing is inspired by strong architectural elements and colors used on various buildings. The components of the sign system were designed individually for optimal functionality while complementing each other in form and finish to create a unified sign family.



Campus Gateways

Campus Gateways are signs and structures distinguishing campus edges or entry portals. For the purposes of this section, precedent images are provided along with a map of proposed locations.

Vehicular Signage

Vehicular signs serve to direct vehicular traffic to campus as well as within, culminating in a clear system of parking signs. As such, these signs are scaled to account for various roadway conditions encountered around campus. The integration of digital message counters on vehicular directional and parking signage aids in the overall efficiency of traffic movement and congestion on campus by being able to communicate garage capacities in advance of decisions points.

Pedestrian Signage

Pedestrian signs and maps are intended to orient and direct individuals throughout the campus. This includes signs identifying the name and address of a building or facility, including building-mounted and freestanding configurations. This system also includes signs to facilitate pedestrian navigation for individuals with accessibility needs. Additionally, the use of digital screens for the pedestrian map kiosks will allow for greater flexibility when implementing map updates while reducing the need for manual access to sign cabinets.

Architectural Lettering

Architectural Lettering is defined as letters affixed to building facades intended to provide identification from a greater viewing distance and mark arrival to a particular building.

Educational Signs

Signs and plaques used to communicate unique aspects of both the natural and built environments of the campus. For the purposes of this section, precedent images/templates are provided.

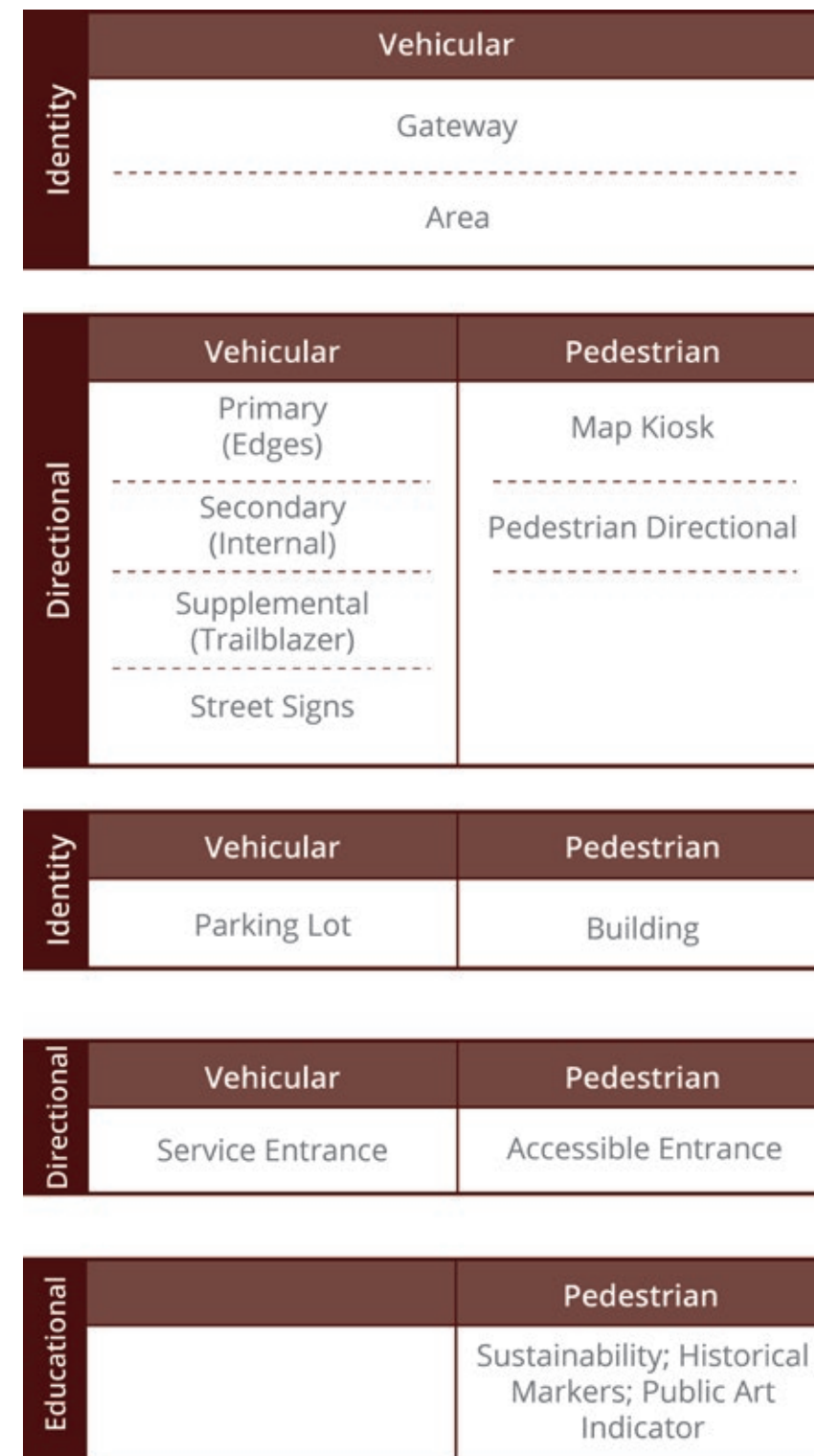

Sign Type Hierarchy Diagram

Campus Gateways

Well-defined campus gateways establish a front door and reinforce University identity or brand, aid in wayfinding and reinforce a sense of place. Primary gateways typically feature monument signs with the name of the institution only. These signs should be classic designs that are expressive of the University's brand image. In addition to monument signage at these entrances, appropriate landscaping, lighting, seating, and hardscaping should be used to create a backdrop for the signage. Texas A&M has the opportunity for campus gateway signage along the periphery of the campus, specifically at the following major corners of the campus and major entrances:

Large Gateway Monument Signs

- Texas Avenue and University Drive
- Raymond Stotzer Parkway and Harvey Mitchell Parkway
- George Bush Drive and Harvey Mitchell Parkway
- Texas Avenue and George Bush Drive
- Texas Avenue and New Main Drive

Smaller Gateways Monument Signs

- Wellborn Road and George Bush Drive
- Wellborn Road and Harvey Mitchell Parkway
- Bizzell Street and New Main Drive

For areas of campus that request specific signage at the periphery of campus, the name of the entity is permitted. These signs are referred to as 'area' signs. An example of an existing area sign is located at the corner of Research Parkway and Raymond Stotzer Parkway to indicate the entrance to Research Park. These area signs are not intended to specify each academic program or department on the campus, but instead are meant to indicate specific areas of campus that are geographically separate (Veterinary Medicine and Biomedical Sciences, Health Sciences Center, Equine Center) or programmatically separate (Research Park, Bush Presidential Library). Area signs are smaller in scale than primary gateway signs, and feature both the name of the institution and the name of the program or area.



Campus Gateway at the University of Scranton



Campus Gateway at Towson University

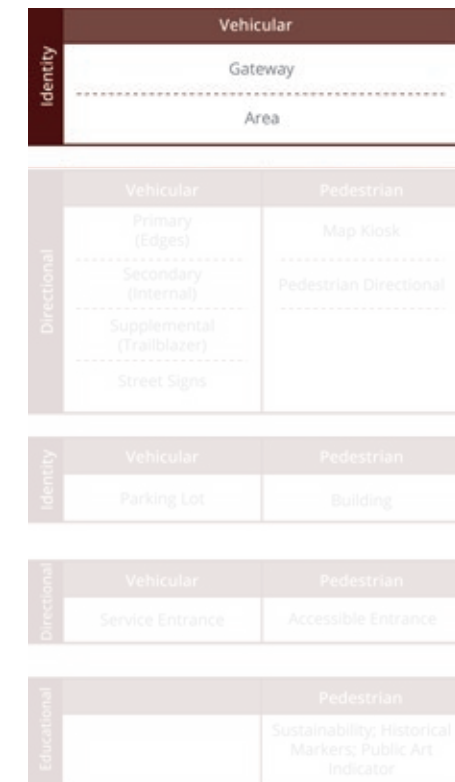

Sign Type Hierarchy Diagram

Health
sciences
campus

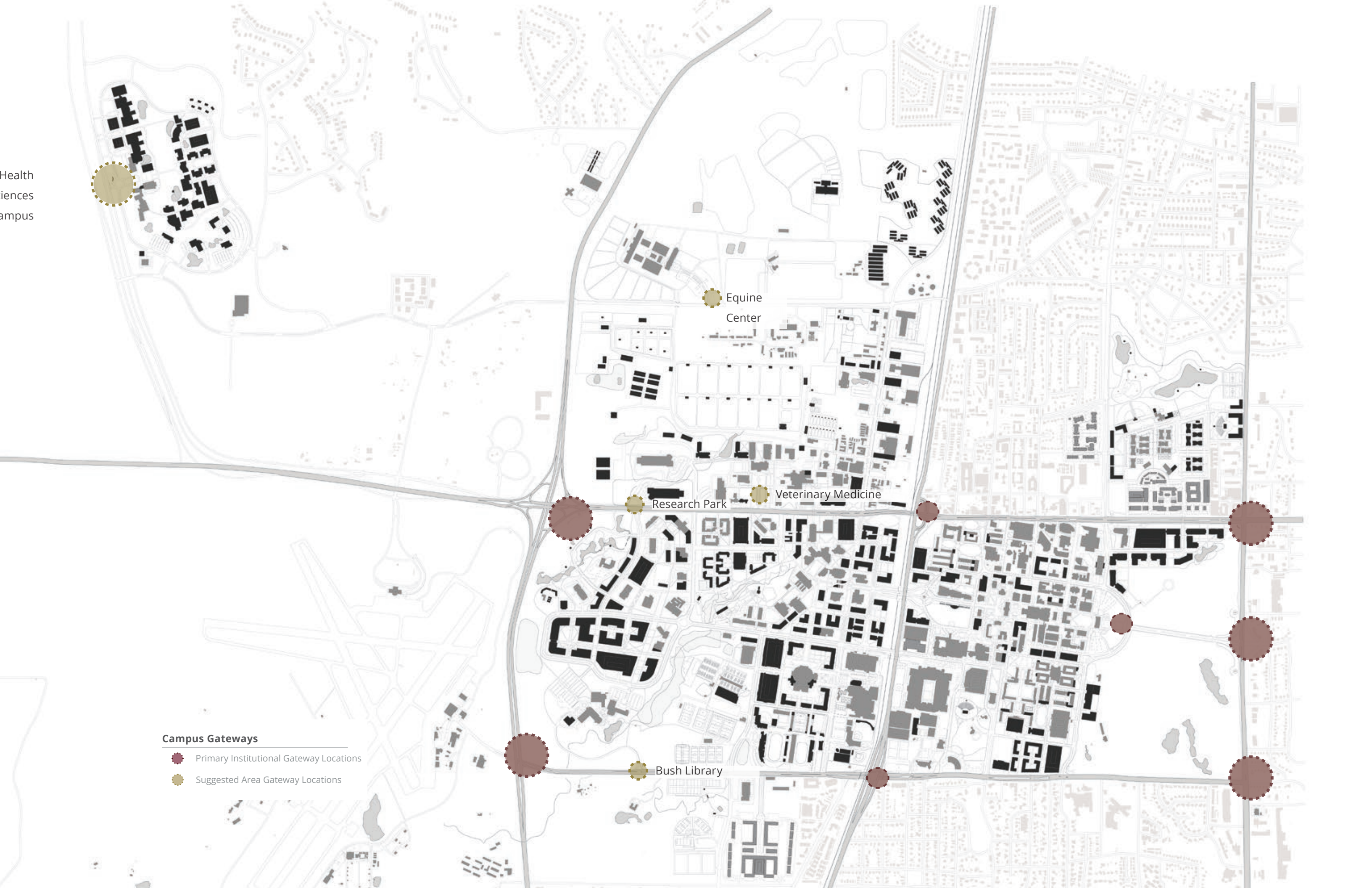

Campus Gateways

- Primary Institutional Gateway Locations
- Suggested Area Gateway Locations

Equine
Center

Research Park

Veterinary Medicine

Bush Library

Vehicular Signage

Vehicular signs guide motorists to key locations and identify destinations such as parking. The signs provide guidance through brief messages and directional arrows. Messages should be appropriately scaled for legibility at driving speeds.

Vehicular signs offer a first impression of the University. The new system of vehicular signs is a clean, bold update to the University's existing system. Panel and text colors were selected for maximum legibility and all vehicular signs receive reflective vinyl for nighttime viewing.



Parking Lot Identification



Vehicular Directional



Trailblazer

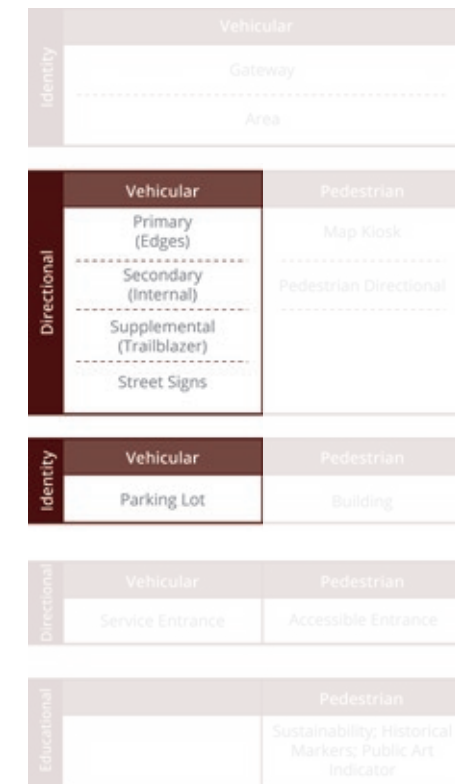

Sign Type Hierarchy Diagram

Vehicular Signage Family

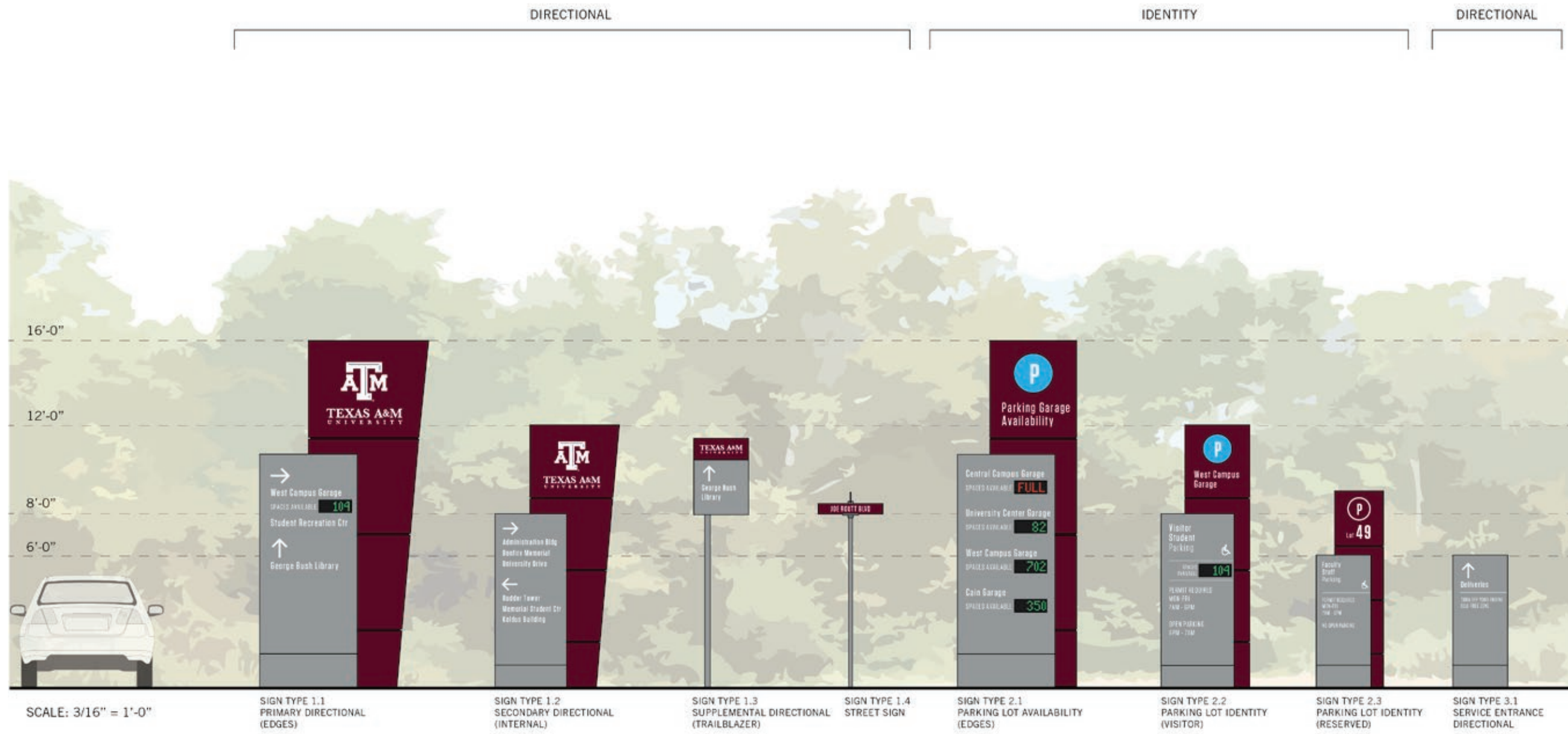

Sign Type 1.1 - Primary Directional (Edges)

Vehicular directional signs guide motorists to Key Destinations and parking lots. These signs provide guidance through brief messages and directional arrows. Messages must be legible at driving speeds.

General Specifications:

1. Fabricated aluminum monolith, surface painted P1
2. Push-through acrylic logo (internally illuminated) - 2'-11" tall as shown
3. Fabricated aluminum monolith (54" wide), surface painted P2
4. Push-through arrows (internally illuminated) - 8" tall as shown
5. Push-through copy (internally illuminated) - 4" and 3" tall as shown
6. Digital parking counter - 5" tall digits as shown

Design Criteria:

- Logo shall be internally illuminated
- Text and symbols shall be internally illuminated
- May include digital parking lot component as shown
- Destinations listed right, left, and straight ahead
- No more than 6 lines of text

Location Criteria:

- Right side of each drive lane in unobstructed locations (with individual exceptions as required by site conditions)
- Announce turns prior to intersections by a safe margin at driving speed
- Programmed with the first-time visitor in mind
- Direct drivers to Parking Areas first
- Perpendicular to travel lane
- Min. 3'-0" from curb to edge of sign

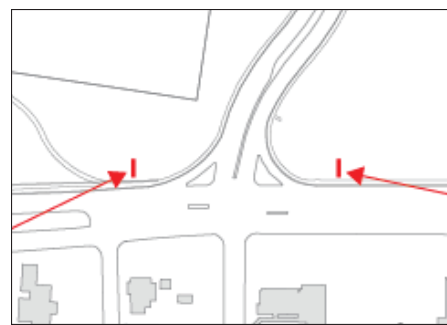

Typical Sign Placement

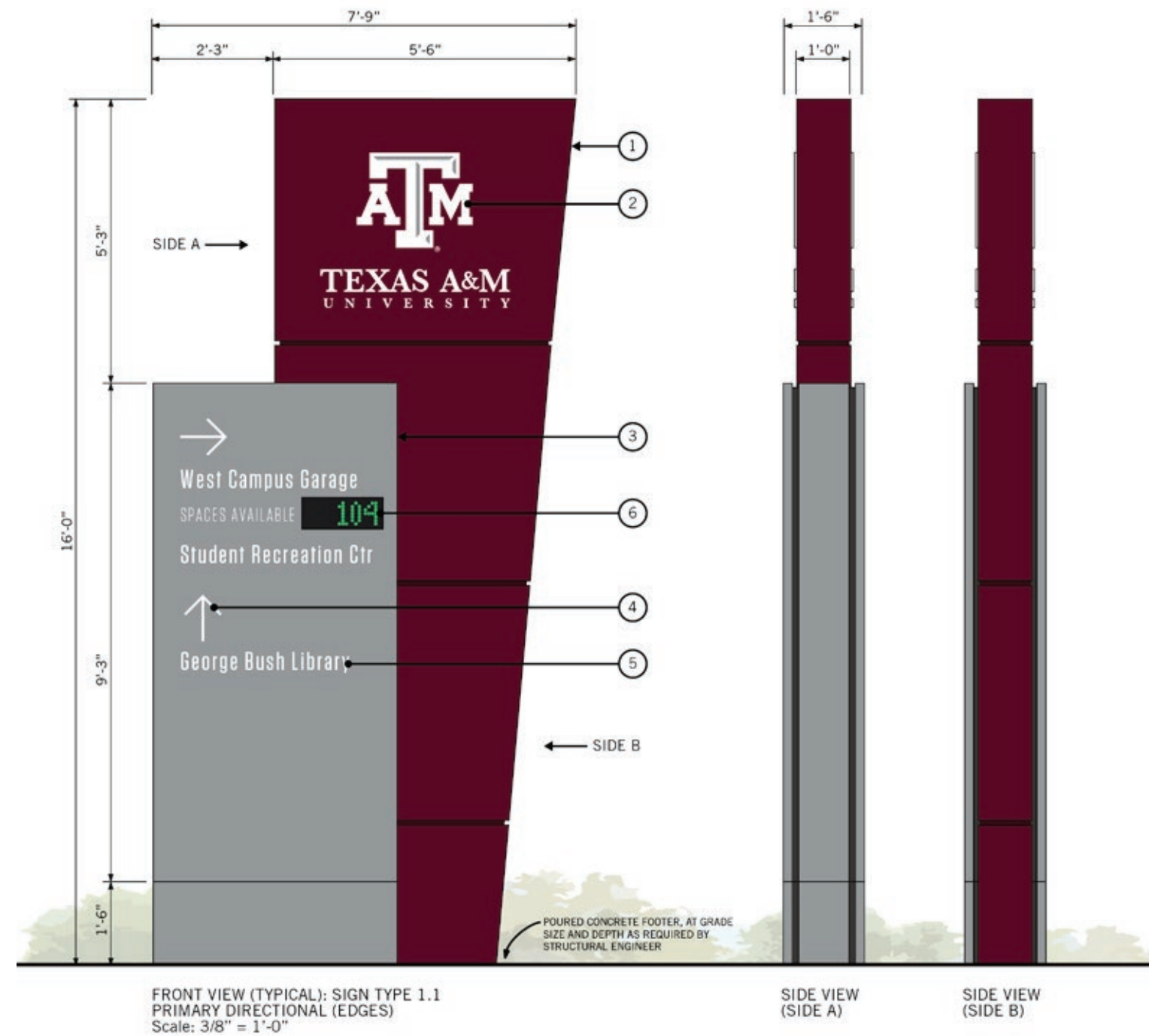

Sign Type 1.1 - Primary Directional (Edges) Stone Monolith Alt.

Vehicular directional signs guide motorists to Key Destinations and parking lots. These signs provide guidance through brief messages and directional arrows. Messages must be legible at driving speeds.

General Specifications:

1. Cast stone monolith, material M1
2. Etched non-filled logo (non-illuminated) - 2'-11" tall as shown
3. Fabricated aluminum monolith (54" wide), surface painted P2
4. Push-through arrows (internally illuminated) - 8" tall as shown
5. Push-through copy (internally illuminated) - 4" and 3" tall as shown
6. Digital parking counter - 5" tall digits as shown

Design Criteria:

- Logo shall be etched into stone w/ no fill
- Text and symbols shall be internally illuminated
- May include digital parking lot component as shown
- Destinations listed right, left, and straight ahead
- No more than 6 lines of text

Location Criteria:

- Right side of each drive lane in unobstructed locations (with individual exceptions as required by site conditions)
- Announce turns prior to intersections by a safe margin at driving speed
- Programmed with the first-time visitor in mind
- Direct drivers to Parking Areas first
- Perpendicular to travel lane
- Min. 3'-0" from curb to edge of sign

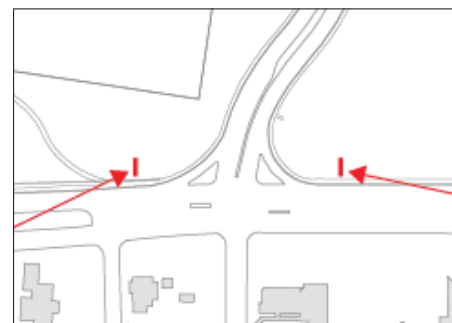

Typical Sign Placement

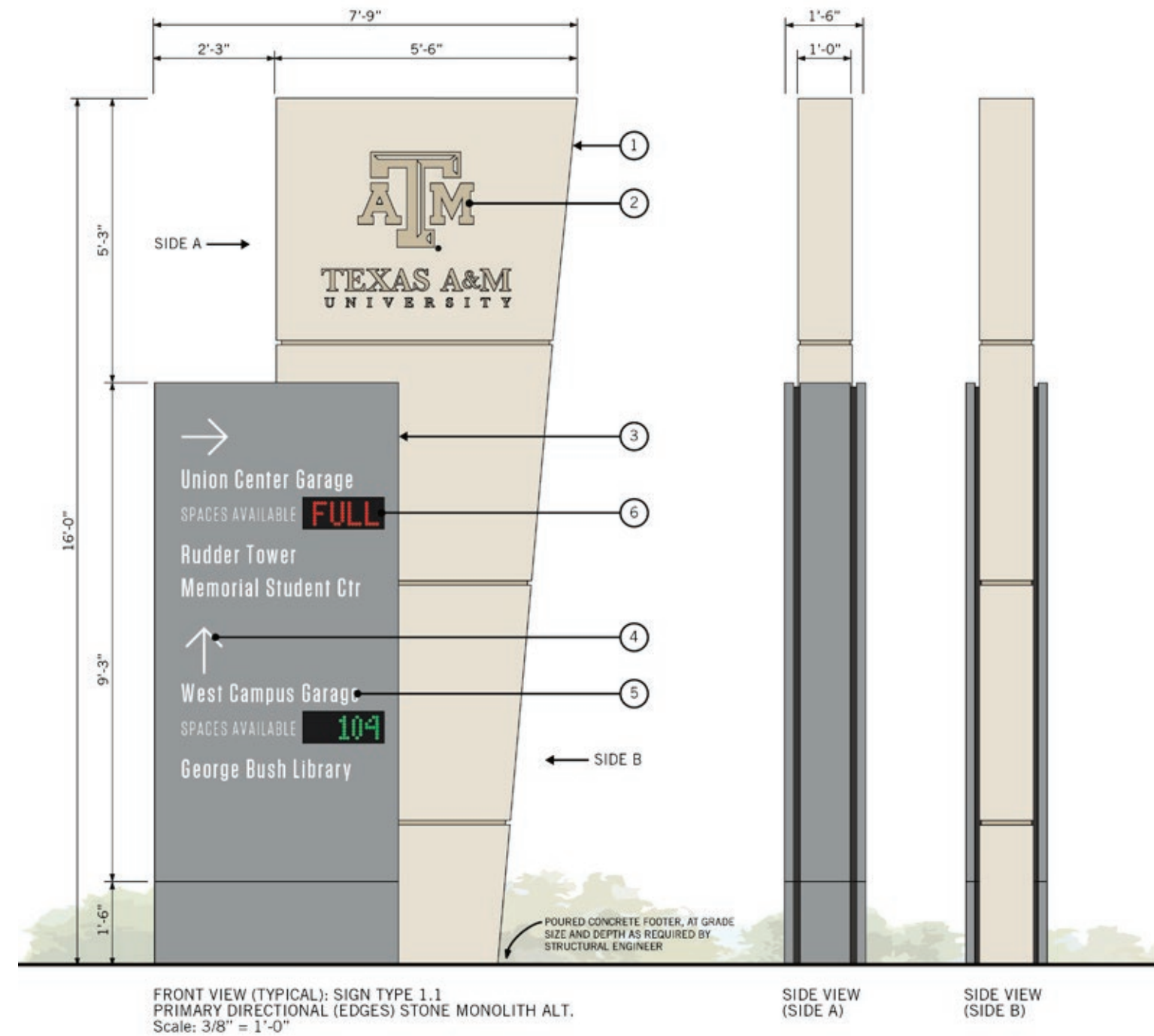

Sign Type 1.2 - Secondary Directional (Internal)

Vehicular directional signs guide motorists to Key Destinations and parking lots. These signs provide guidance through brief messages and directional arrows. Messages must be legible at driving speeds.

General Specifications:

1. Fabricated aluminum monolith, surface painted P1
2. Push-through acrylic logo (internally illuminated) - 2'-2" tall as shown
3. Fabricated aluminum monolith (40" wide), surface painted P2
4. Push-through arrows (internally illuminated) - 6" tall as shown
5. Push-through copy (internally illuminated) - 3.5" tall as shown

Design Criteria:

- Logo shall be internally illuminated
- Text and symbols shall be internally illuminated
- Destinations listed right, left, and straight ahead
- No more than 6 lines of text

Location Criteria:

- Right side of each drive lane in unobstructed locations
- Announce turns prior to intersections by a safe margin at driving speed
- Programmed with the first-time visitor in mind
- Direct drivers to Parking Areas first
- Perpendicular to travel lane
- Min. 3'-0" from curb to edge of sign

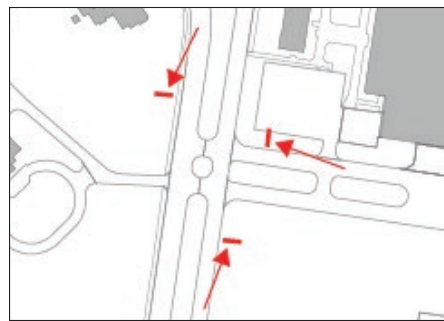

Typical Sign Placement

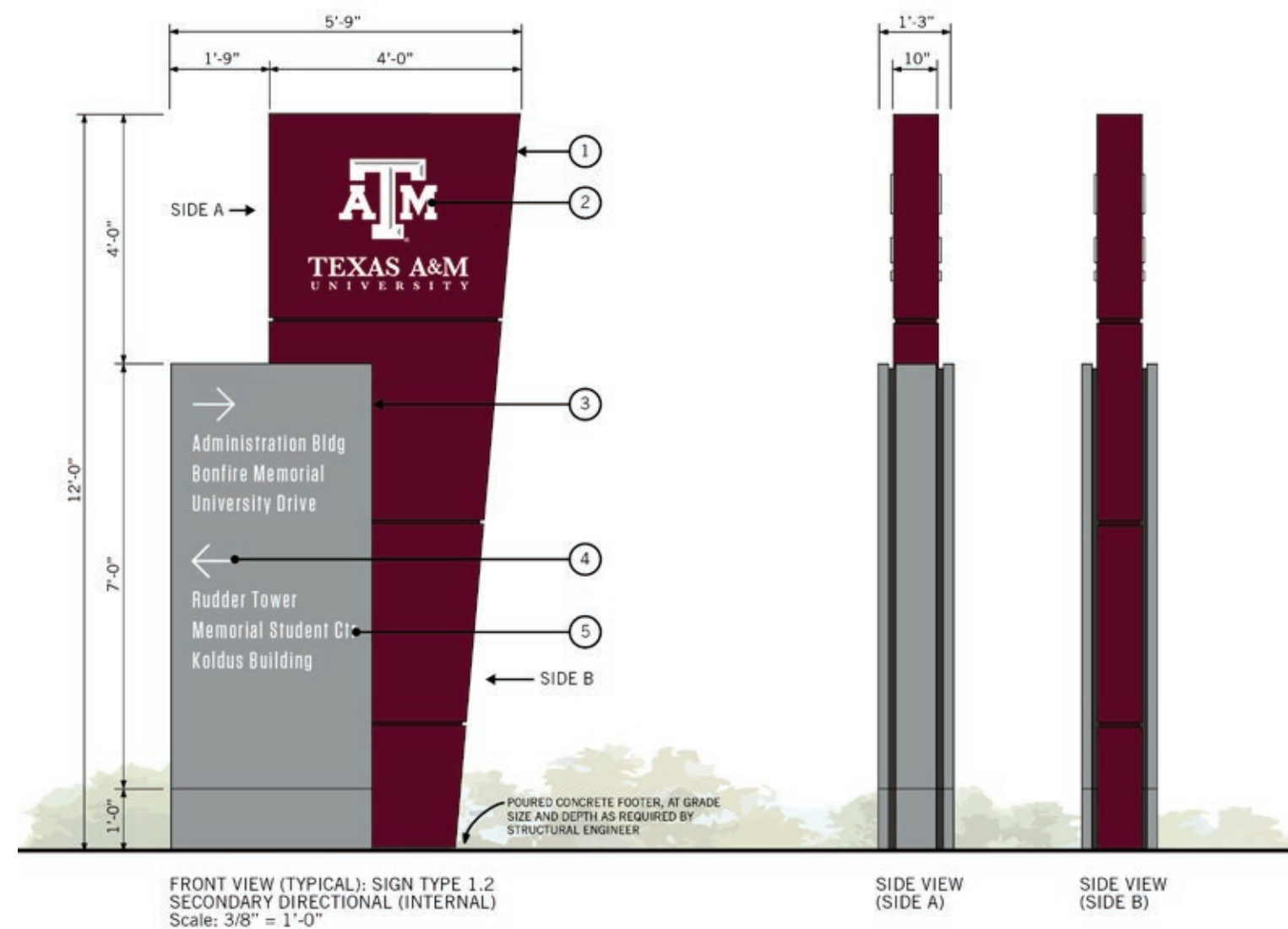

Sign Type 1.3 - Supplemental Directional (Trailblazer)

Vehicular directional signs guide motorists to Key Destinations and parking lots. These signs provide guidance through brief messages and directional arrows. Messages must be legible at driving speeds.

General Specifications:

1. Aluminum sign backer, surface painted P1
2. Applied reflective vinyl logo - V1 - 5" tall as shown
3. Aluminum sign face, surface painted P2
4. Applied reflective vinyl arrows - V1 - 6" tall as shown
5. Applied reflective vinyl copy - V1 - 3.5" tall as shown
6. Aluminum sign post (square), surface painted P2

Design Criteria:

- Logo shall be reflective white vinyl
- Text and symbols shall be reflective white
- No more than 2 lines of text

Location Criteria:

- Right side of each drive lane in unobstructed locations
- Announce turns prior to intersections by a safe margin at driving speed
- Programmed with the first-time visitor in mind
- Direct drivers to Parking Areas first
- Perpendicular to travel lane
- Min. 3'-0" from curb to edge of sign

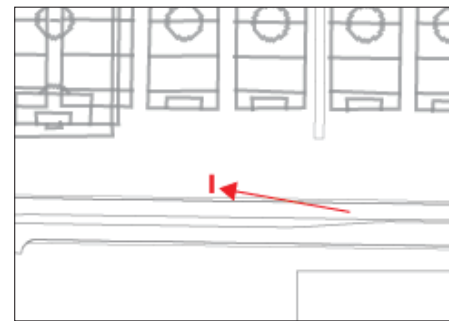

Typical Sign Placement

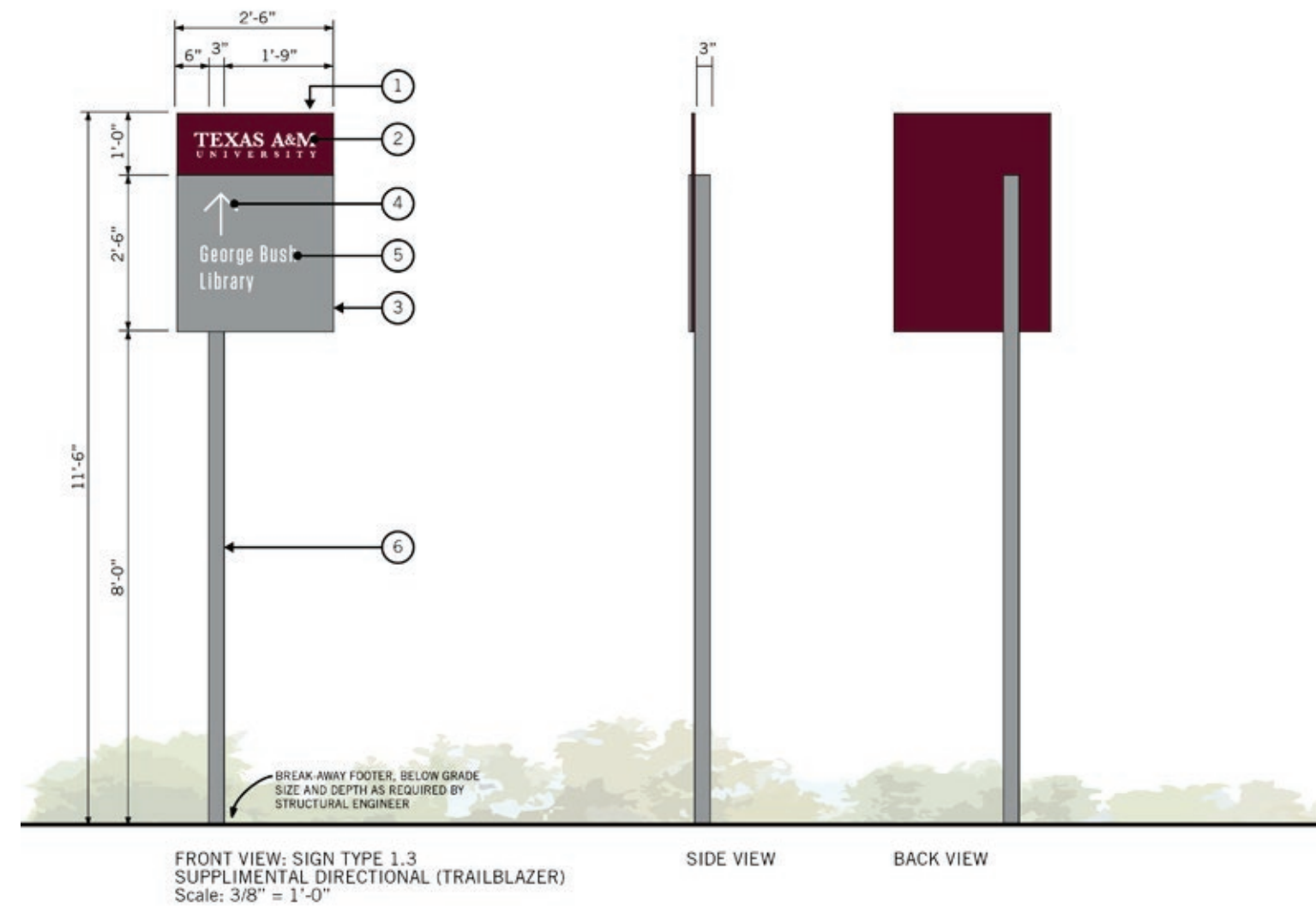

Sign Type 1.4 - Street Sign

Vehicular directional signs guide motorists to Key Destinations and parking lots. These signs provide guidance through brief messages and directional arrows. Messages must be legible at driving speeds.

General Specifications:

1. Aluminum sign panel, surface painted P1
2. Applied reflective vinyl copy - V1 - 3' tall as shown
3. Aluminum mounting brackets, surface painted P2
4. Aluminum sign post (round), surface painted P2

Design Criteria:

- Text shall be reflective white vinyl

Location Criteria:

- Located at intersections as required by state and local municipalities
- Min. 3'-0" from curb to edge of sign



Typical Sign Placement

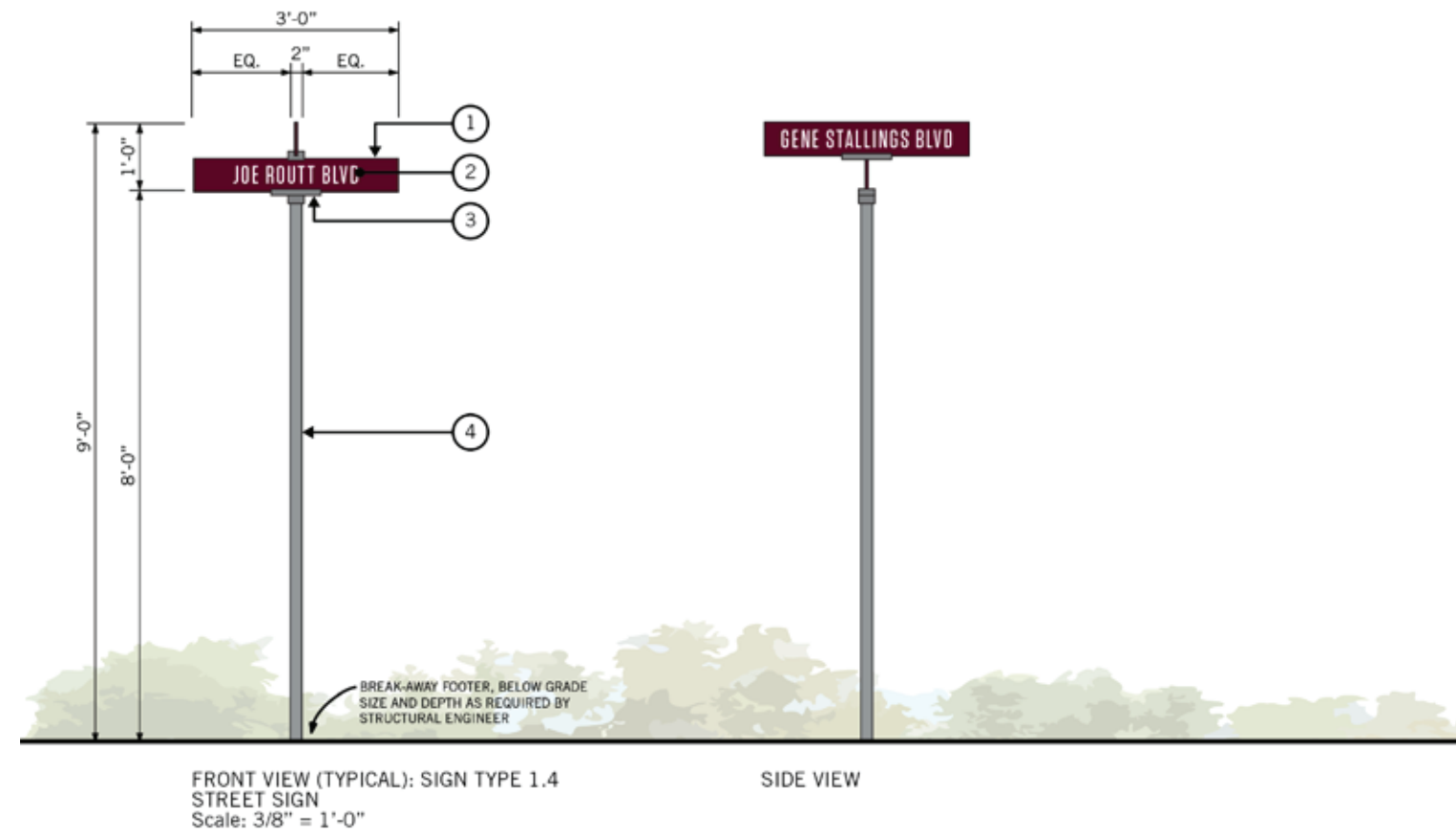

Sign Type 3.1 - Service Entrance Directional

Vehicular directional signs guide motorists to Key Destinations and parking lots. These signs provide guidance through brief messages and directional arrows. Messages must be legible at driving speeds.

General Specifications:

1. Fabricated aluminum monolith, surface painted P2
2. Applied reflective vinyl arrows - V1 - 6" tall as shown
3. Applied reflective vinyl copy - V1 - 3.5" and 2.25" tall as shown

Design Criteria:

- Text and symbols shall be reflective white
- No more than 4 lines of text

Location Criteria:

- Right side of each drive lane in unobstructed locations
- Perpendicular to travel lane
- Min. 3'-0" from curb to edge of sign



Typical Sign Placement

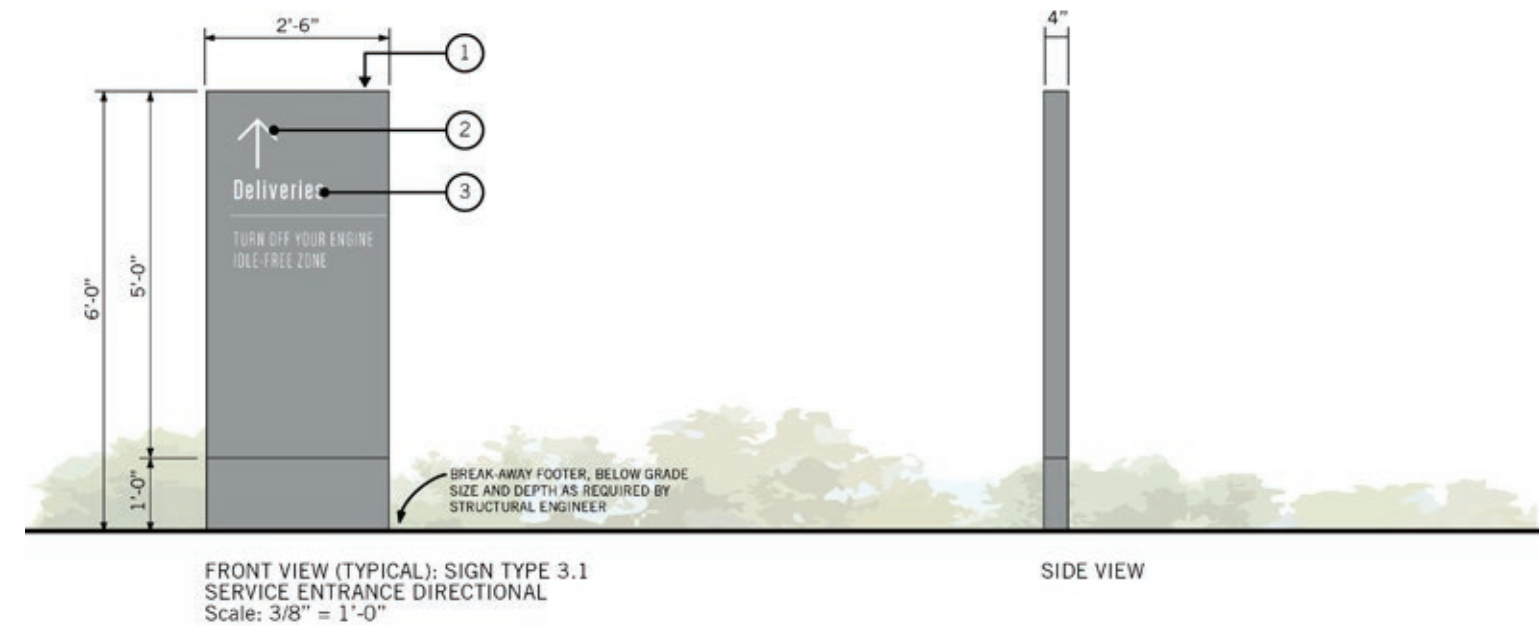

Sign Type 2.1 - Parking Availability (Edges)

Lot availability signs provide dynamic information regarding parking garage capacities. Type size and scale were considered to provide maximum legibility for motorists.

General Specifications:

1. Fabricated aluminum monolith, surface painted P1
2. Push-through acrylic parking symbol (internally illuminated) - 22" tall as shown
3. Push-through acrylic copy (internally illuminated) - 5.5" tall as shown
4. Fabricated aluminum monolith (54" wide), surface painted P2
5. Push-through copy (internally illuminated) - 4" and 3" tall as shown
6. Digital parking counter - 5" tall digits as shown

Design Criteria:

- Parking symbol and garage / lot name shall be internally illuminated
- Text shall be internally illuminated
- Includes digital parking lot components (four) as shown

Location Criteria:

- Right side of each drive lane in unobstructed locations (with individual exceptions as required by site conditions)
- Programmed with the first-time visitor in mind
- Perpendicular to travel lane
- Min. 3'-0" from curb to edge of sign

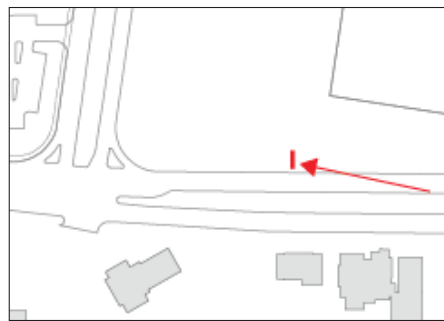

Typical Sign Placement

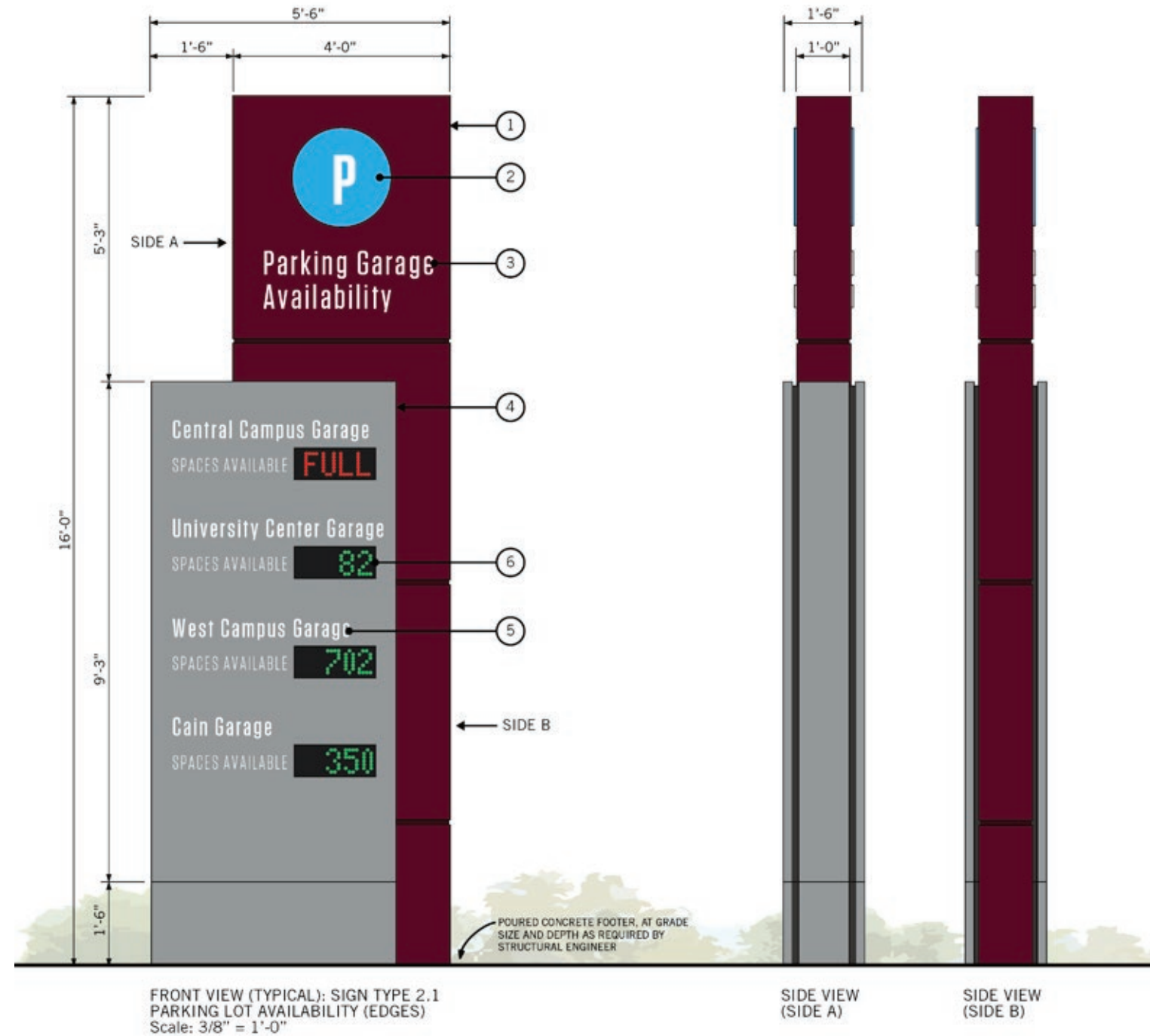

Sign Type 2.1 - Parking Lot Identity (Visitor)

Lot identification signs identify the entrances to parking lots and garages. Type size and scale were considered to provide maximum legibility for motorists.

General Specifications:

1. Fabricated aluminum monolith, surface painted P1
2. Push-through acrylic parking symbol (internally illuminated) - 16" tall as shown
3. Push-through acrylic copy (internally illuminated) - 4" tall as shown
4. Fabricated aluminum monolith (40" wide), surface painted P2
5. Applied reflective vinyl copy - V1 - 4" and 3" tall as shown
6. Applied reflective vinyl accessible symbol - V1 - 6" tall as shown
7. Digital parking counter - 5" tall digits as shown

Design Criteria:

- Parking symbol and garage / lot name shall be internally illuminated
- Text and symbols shall be reflective white vinyl
- Clearly identifies lot number at entrances
- Identifies if accessible parking is available
- May include digital parking lot component as shown
- Sign is double-sided

Location Criteria:

- Located at visitor lot entrances
- Perpendicular to travel lane served by lot (with exceptions as required by site conditions)
- Min. 3'-0" from curb to edge of sign
- Located as not to disrupt motorists' sight lines

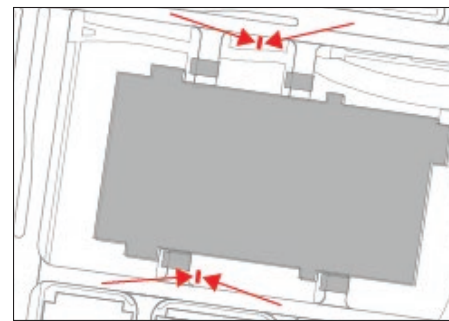

Typical Sign Placement

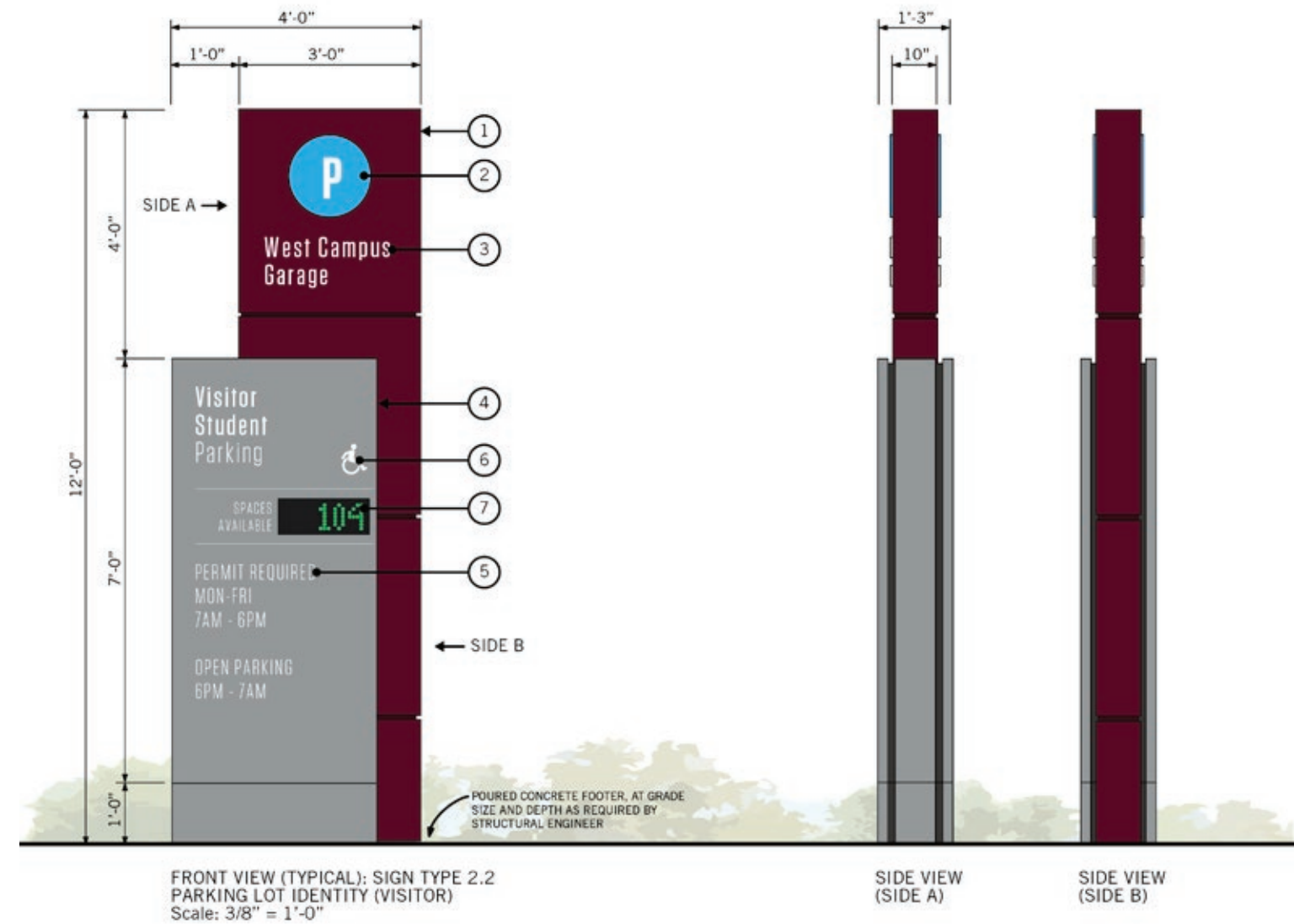

Sign Type 2.1 - Parking Lot Identity (Visitor) Surface Lot Alt.

Lot identification signs identify the entrances to parking lots and garages. Type size and scale were considered to provide maximum legibility for motorists.

General Specifications:

1. Fabricated aluminum monolith, surface painted P1
2. Push-through acrylic parking symbol (internally illuminated) - 16" tall as shown
3. Push-through acrylic copy (internally illuminated) - 4" and 10" tall as shown
4. Fabricated aluminum monolith (40" wide), surface painted P2
5. Applied reflective vinyl copy - V1 - 4" and 3" tall as shown
6. Applied reflective vinyl accessible symbol - V1 - 6" tall as shown

Design Criteria:

- Parking symbol and garage / lot name shall be internally illuminated
- Text and symbols shall be reflective white vinyl
- Clearly identifies lot number at entrances
- Identifies if accessible parking is available
- Sign is double-sided

Location Criteria:

- Located at visitor lot entrances
- Perpendicular to travel lane served by lot (with exceptions as required by site conditions)
- Min. 3'-0" from curb to edge of sign
- Located as not to disrupt motorists' sight lines

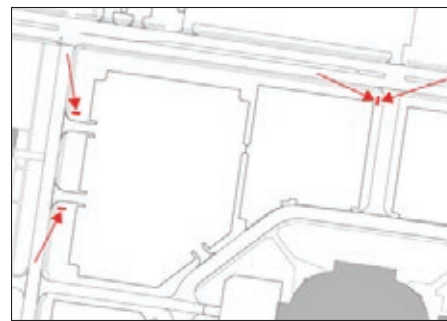

Typical Sign Placement

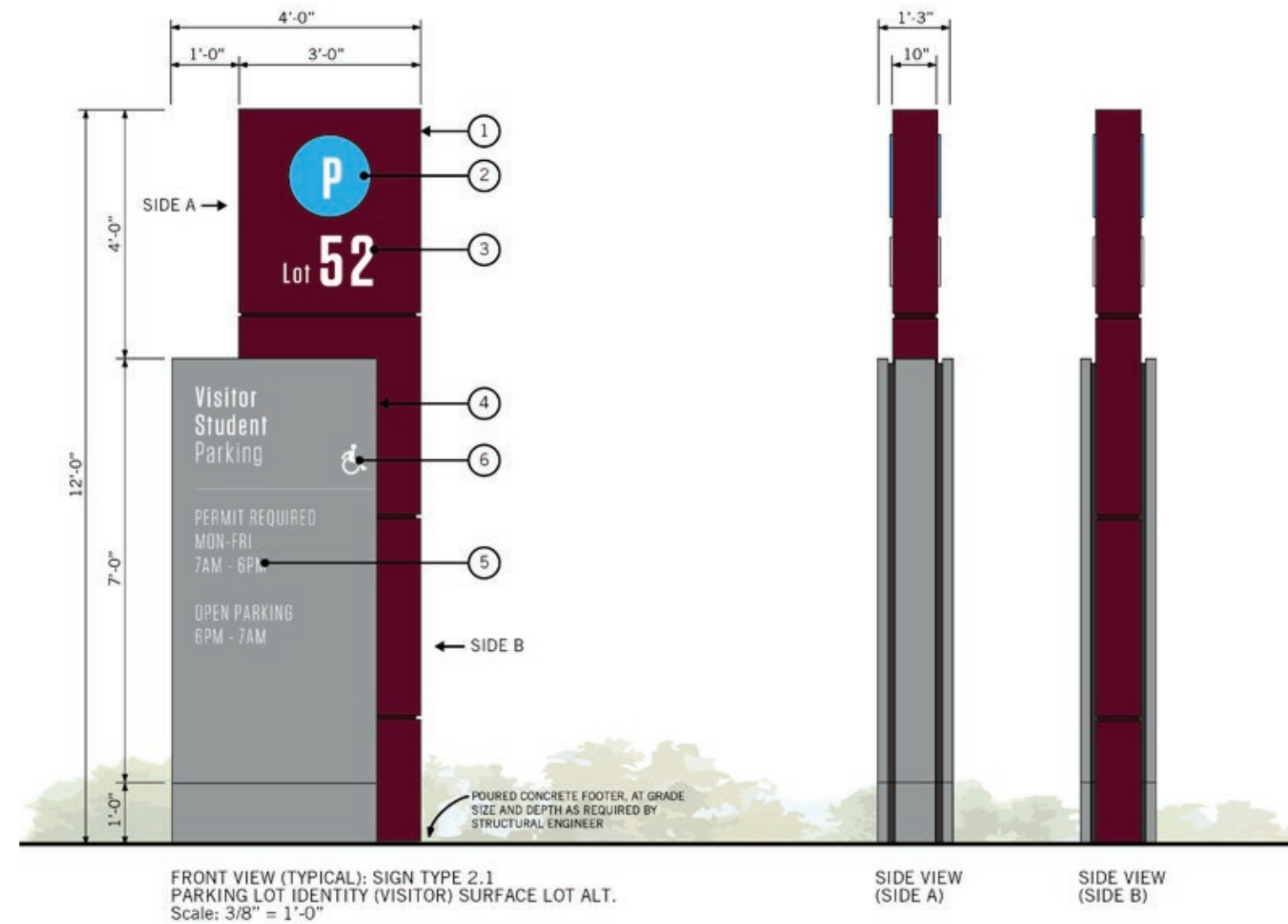

Sign Type 2.2 - Parking Lot Identity (Reserved)

Lot identification signs identify the entrances to parking lots and garages. Type size and scale were considered to provide maximum legibility for motorists.

General Specifications:

1. Fabricated aluminum monolith, surface painted P1
2. Applied reflective vinyl parking symbol - V1 - 12" tall as shown
3. Applied reflective vinyl copy - V1 - 3" and 7.5" tall as shown
4. Fabricated aluminum monolith (30" wide), surface painted P2
5. Applied reflective vinyl copy - V1 - 3" and 2.25" tall as shown
6. Applied reflective vinyl accessible symbol - V1 - 4.5" tall as shown

Design Criteria:

- Text and symbols shall be reflective white vinyl
- Clearly identifies lot number at entrances
- Identifies if accessible parking is available
- Sign is double-sided

Location Criteria:

- Located at reserved lot entrances
- Perpendicular to travel lane served by lot (with individual exceptions as required by site conditions)
- Min. 3'-0" from curb to edge of sign
- Located as not to disrupt motorists' sight lines

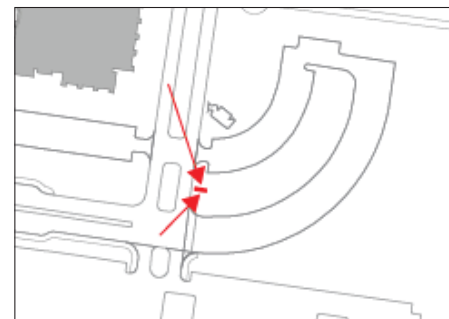

Typical Sign Placement

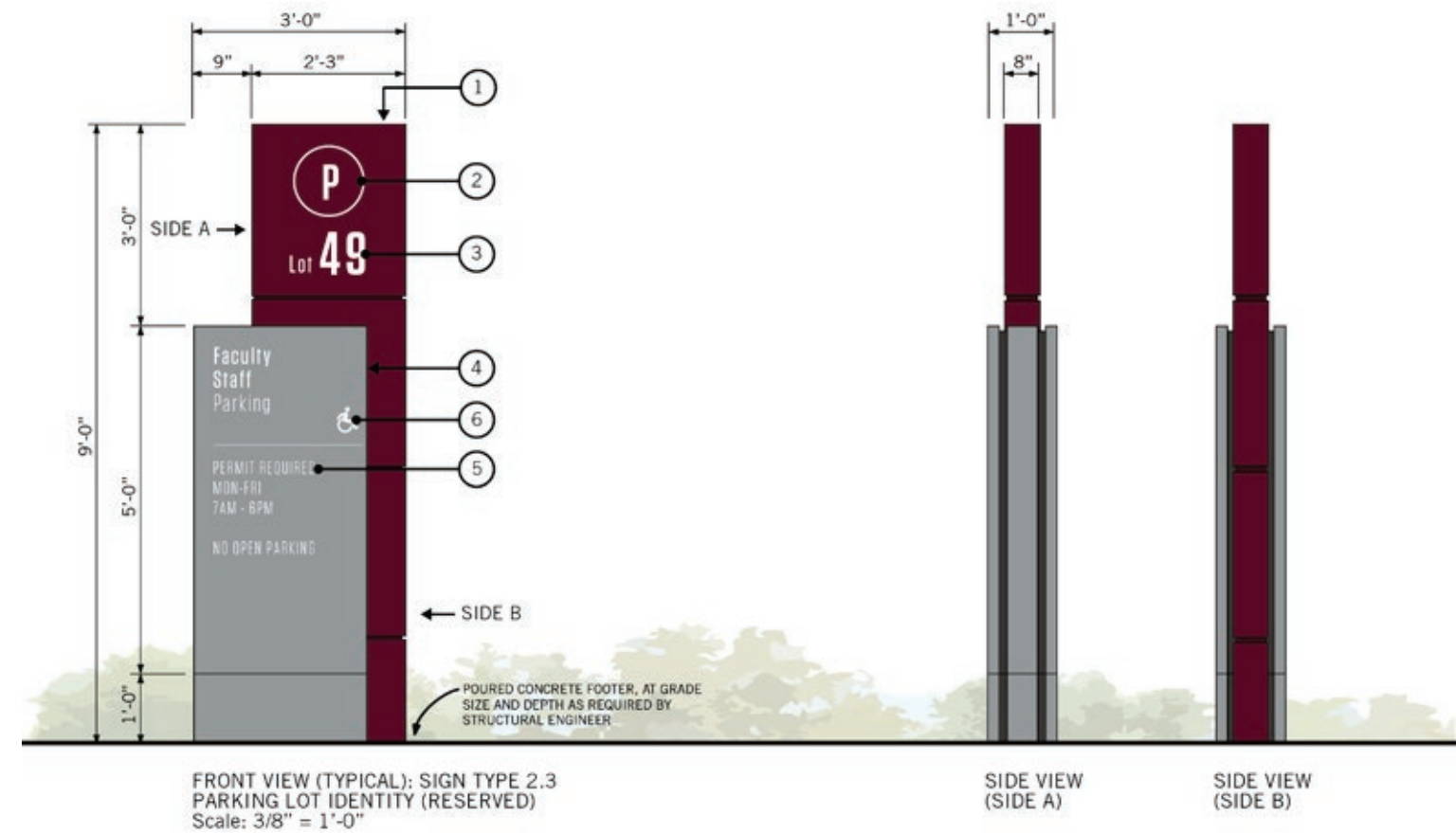

Pedestrian Signage

Pedestrian signs guide pedestrians to their campus destination and identify their destination upon arrival. They complement intuitive paths and paving and provide guidance at decision points. Because pedestrian signs are viewed at a close distance, decorative elements, such as post details, are more refined than on vehicular signs.

Non-accessible paths are marked with a secondary wayfinding sign, clearly labeled “accessible route.”

Signs are also placed at building entrances to indicate accessible entry.



Map Kiosk



Building Identification



Pedestrian Directional

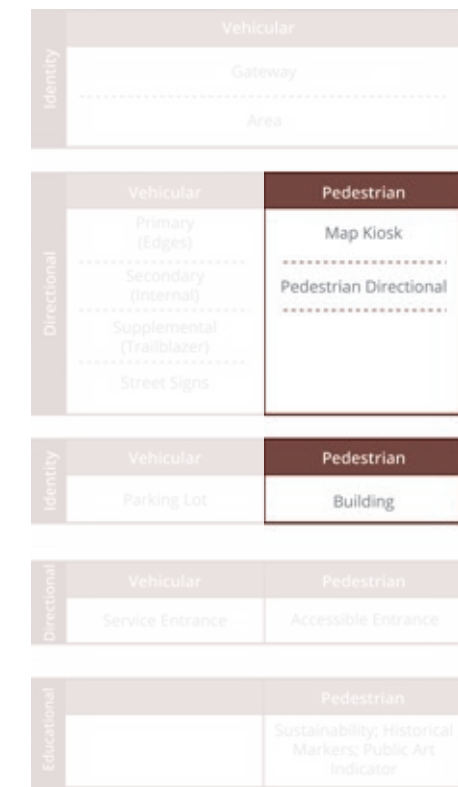

Sign Type Hierarchy Diagram

Pedestrian Signage Family

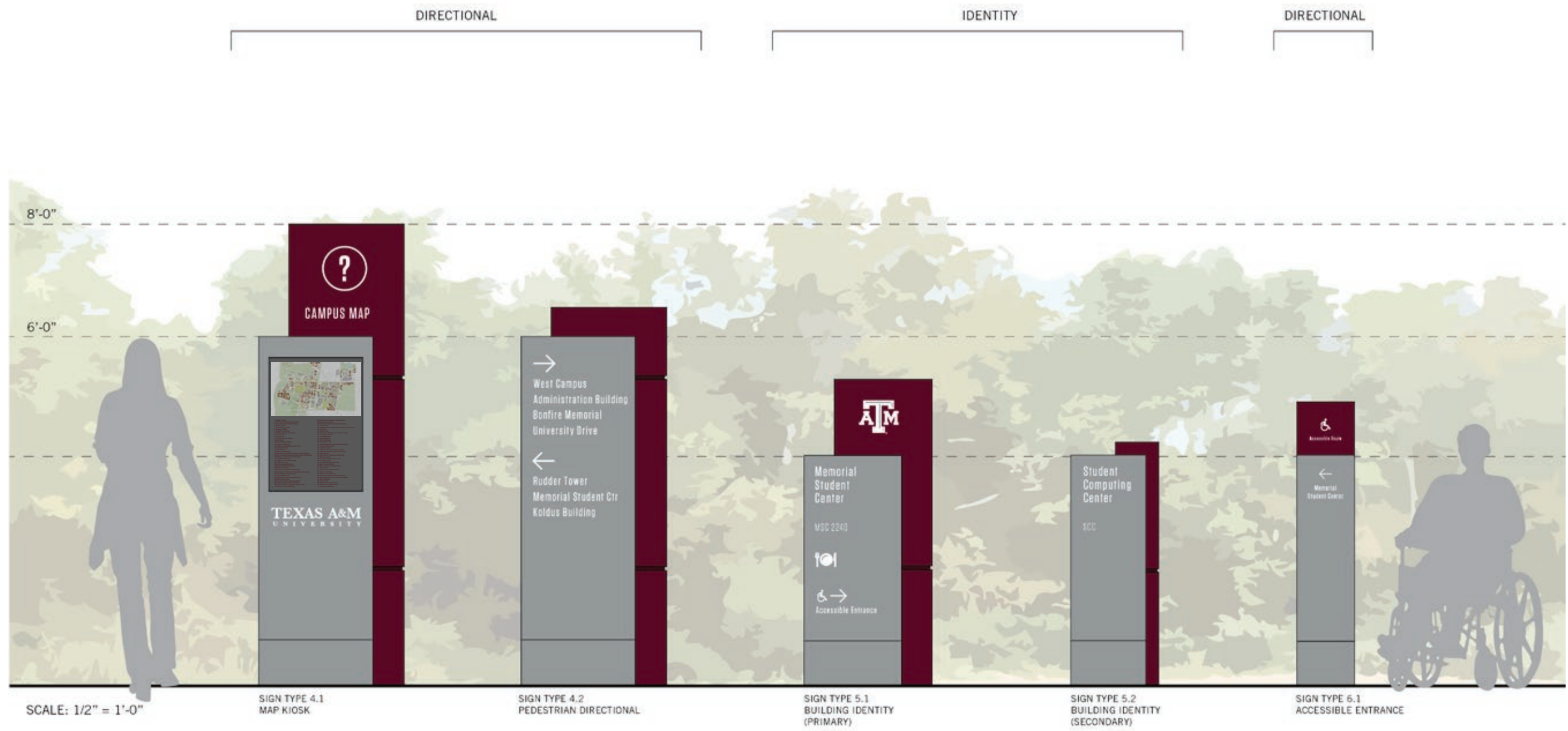

Sign Type 4.1 - Map Kiosk

Map kiosks are easily recognizable and assist visitors in quickly locating their destinations. Directories carry more information than directional signs including all building names and select destinations within buildings.

General Specifications:

1. Fabricated aluminum monolith, surface painted P1
2. Push-through acrylic information symbol (internally illuminated) - 9" tall as shown
3. Push-through acrylic copy (internally illuminated) - 2.25" tall as shown
4. Fabricated aluminum monolith (24" wide), surface painted P2
5. Map display case (internally illuminated) - may be digital touch screen - 20" x 28"
6. Push-through acrylic logo (internally illuminated) - 4" tall as shown

Design Criteria:

- Text, symbols, logo, and map display shall be internally illuminated
- Changeable campus map accessible via hinged access door
- Scaled for pedestrian viewing and accessible for ambulatory and wheelchair viewing
- May include information for access to online wayfinding tools
- Sign may be double-sided if conditions allow

Location Criteria:

- Located at transitions from vehicular to pedestrian navigation such as parking lots, pedestrian drop-offs and bus stops
- Located in areas of heavy pedestrian traffic and merging paths

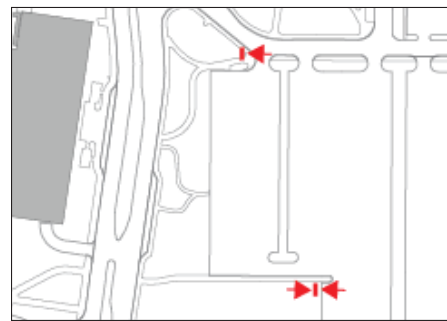

Typical Sign Placement

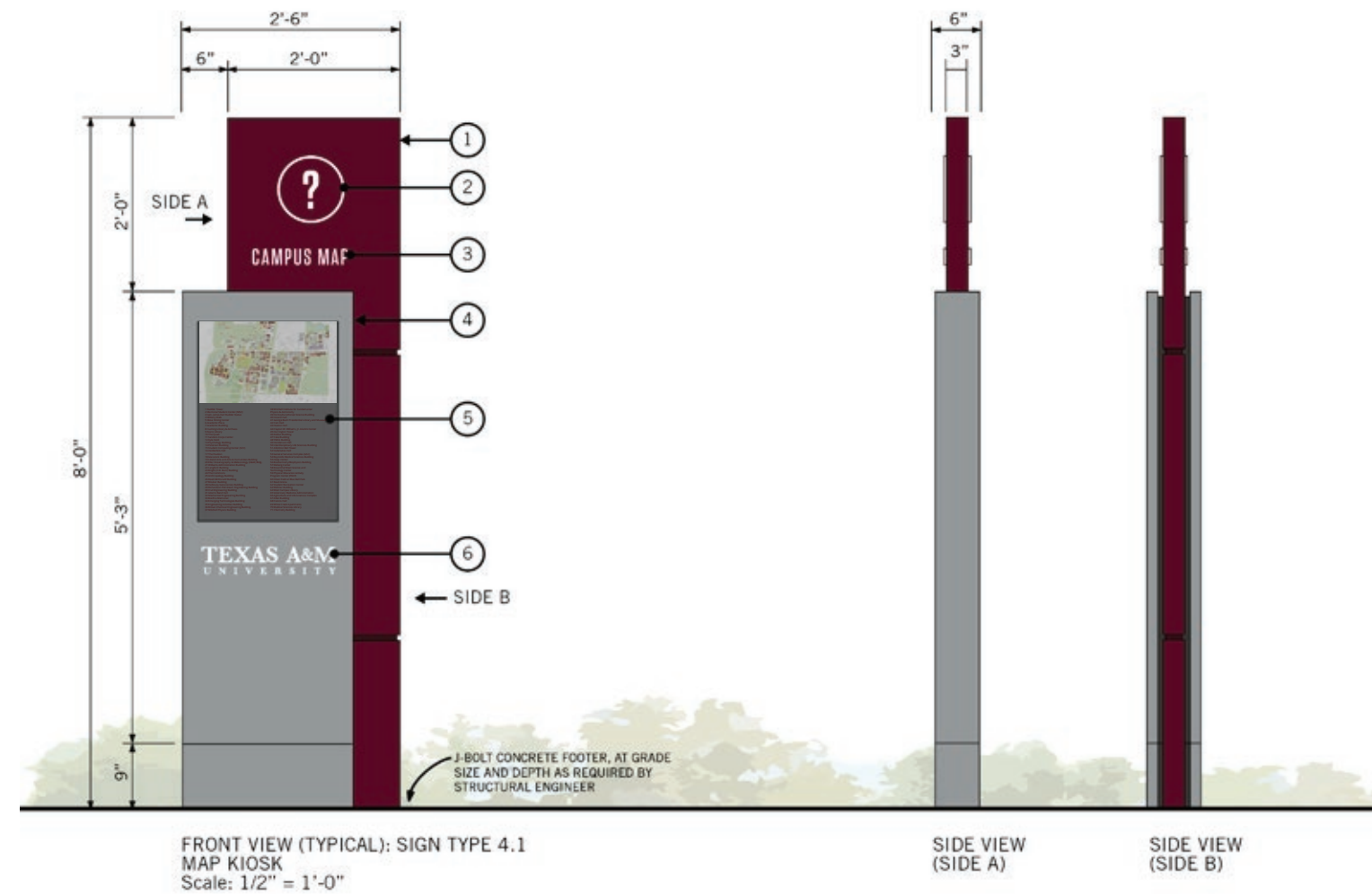

Sign Type 4.2 - Pedestrian Directional

Pedestrian directional signs guide pedestrians to their campus destination. They complement intuitive paths and paving and provide guidance at decision points.

General Specifications:

1. Fabricated aluminum monolith, surface painted P1
2. Applied matte vinyl copy - V1
3. Fabricated aluminum monolith (24" wide), surface painted P2
4. Applied matte vinyl arrows - V2 - 3.5" tall as shown
5. Applied matte vinyl copy - V2 - 1.75" tall as shown

Design Criteria:

- Navigational aid to Key Destinations and Parking Areas
- Delivers adequate information to direct users to the next sign or kiosk
- Destinations listed right, left, and straight ahead
- No more than 10 lines of text
- Destinations based on proximity
- Text and symbols shall be matte vinyl
- Sign may be double-sided if conditions allow

Location Criteria:

- Judiciously placed along pedestrian paths and major decision points
- Oriented perpendicular to path of travel (with some exceptions as required by site conditions)



Typical Sign Placement

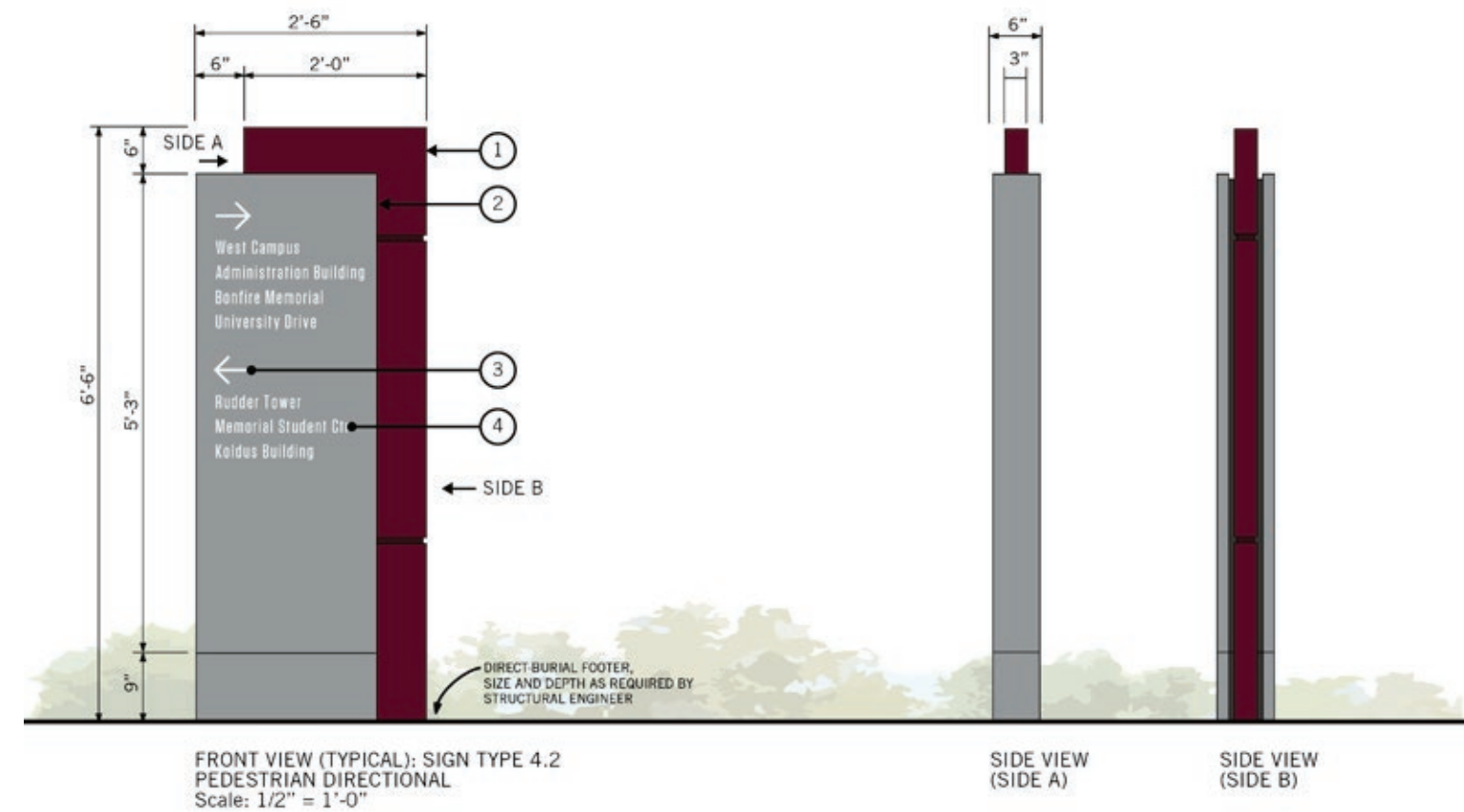

Sign Type 5.1 - Building Identity (Primary)

Building identification signage identifies the formal name of the building. These pedestrian-scaled signs are placed near the main or secondary entrances of the building.

General Specifications:

1. Fabricated aluminum monolith, surface painted P1
2. Applied matte vinyl logo - V1 - 7" tall as shown
3. Fabricated aluminum monolith (20" wide), surface painted P2
4. Applied matte vinyl copy - V2 - 2" and 1.75" tall as shown
5. Applied matte vinyl arrows, accessible symbols, and copy - V2 - 3" and 1.5" tall as shown
6. Applied matte vinyl symbol - V2 - 3" tall as shown (select locations only)

Design Criteria:

- Text, symbols, and logo shall be matte vinyl
- Displays the full building name
- Internal building departments and destinations are not listed on signs
- Includes building short name (schedule abbreviation)
- Includes placeholder for accessible route messaging
- Freestanding signs are single or double-sided depending on site requirements

Location Criteria:

- Placed at primary entrances of each building

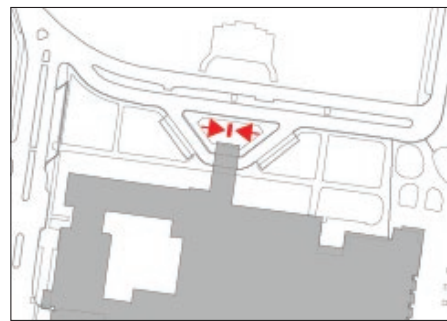

Typical Sign Placement

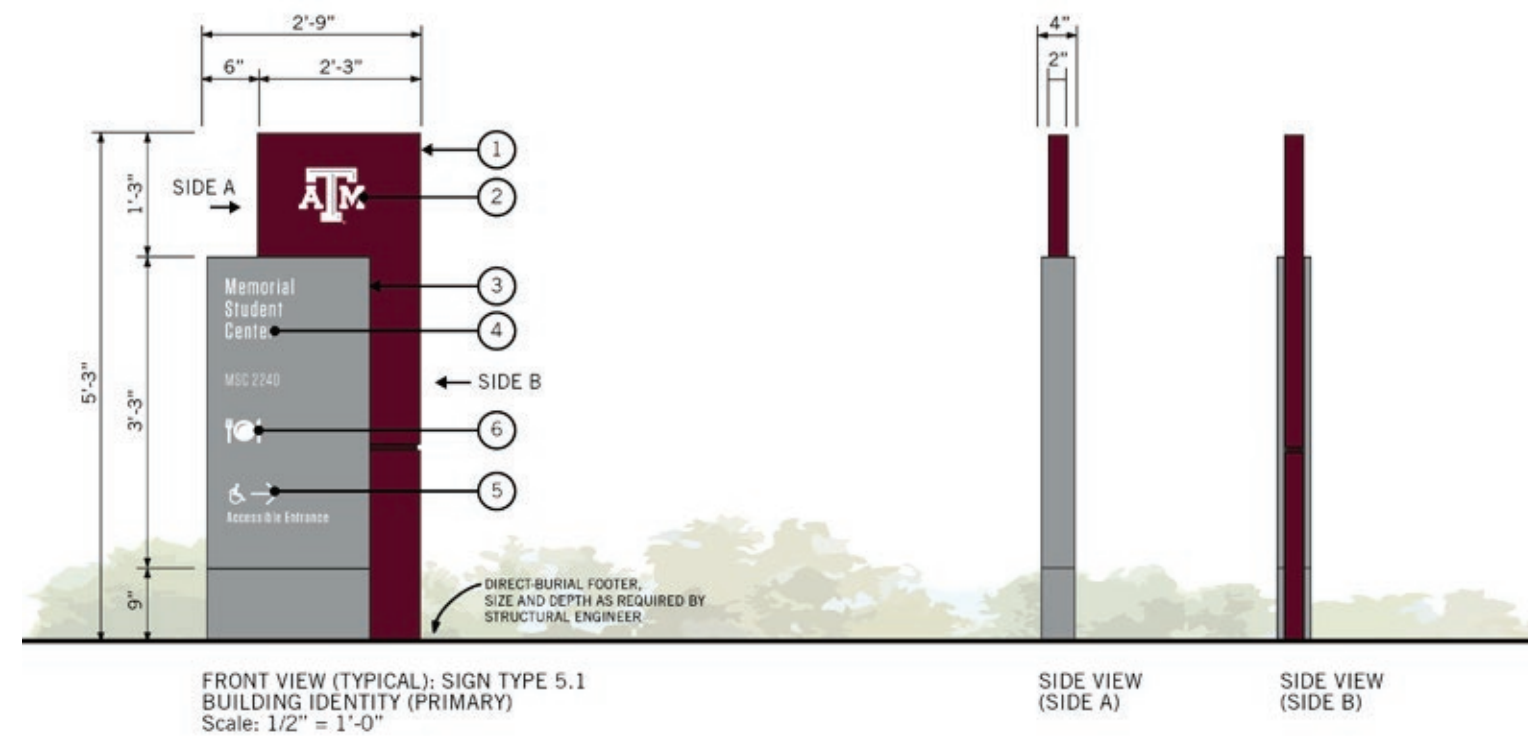

Sign Type 5.2 - Building Identity (Secondary)

Building identification signage identifies the formal name of the building. These pedestrian-scaled signs are placed near the main or secondary entrances of the building.

General Specifications:

- Fabricated aluminum monolith, surface painted P1
- Fabricated aluminum monolith (16" wide), surface painted P2
- Applied matte vinyl copy - V2 - 2" and 1.75" tall as shown

Design Criteria:

- Text and symbols shall be matte vinyl
- Displays the full building name
- Internal building departments and destinations are not listed on signs
- Includes building short name (schedule abbreviation)
- Includes placeholder for accessible route messaging
- Freestanding signs are single or double-sided depending on site requirements

Location Criteria:

- Placed at secondary entrances of each building



Typical Sign Placement

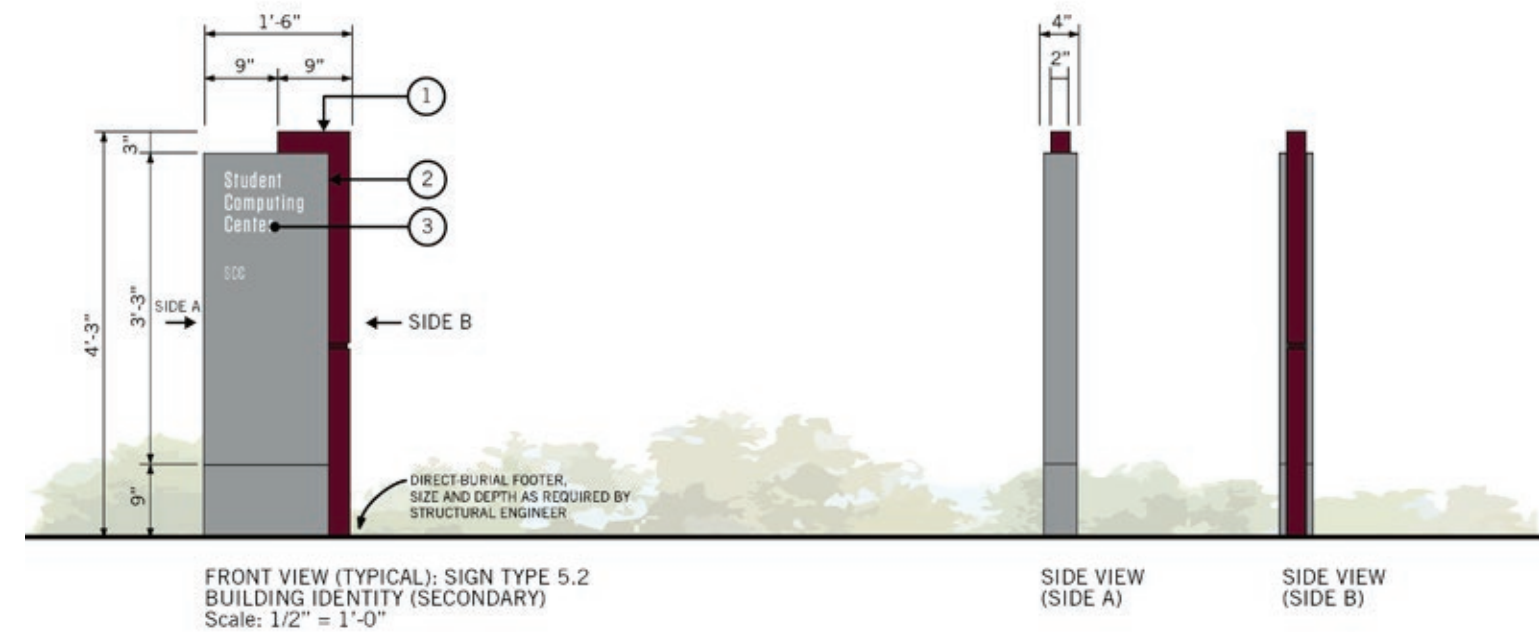

Sign Type 6.1 - Accessible Entrance

Accessible directional signs guide pedestrians to their campus destination via an alternate accessible route. They complement intuitive paths and paving and identify the accessible entrances to a specific building.

General Specifications:

1. Fabricated aluminum monolith, surface painted P1
2. Applied matte vinyl accessible symbol and copy - V1 - 3" and 1" tall as shown
3. Aluminum sign panels, surface painted P2
4. Applied matte vinyl arrows and copy - V2 - 2" and 1.25" tall as shown

Design Criteria:

- Navigational aid to accessible building entrances
- No more than 2 lines of text
- Text and symbols shall be matte vinyl
- Sign may be double-sided if conditions allow

Location Criteria:

- Placed for directing to secondary accessible entrances of buildings
- Oriented perpendicular to path of travel (with some exceptions as required by site)

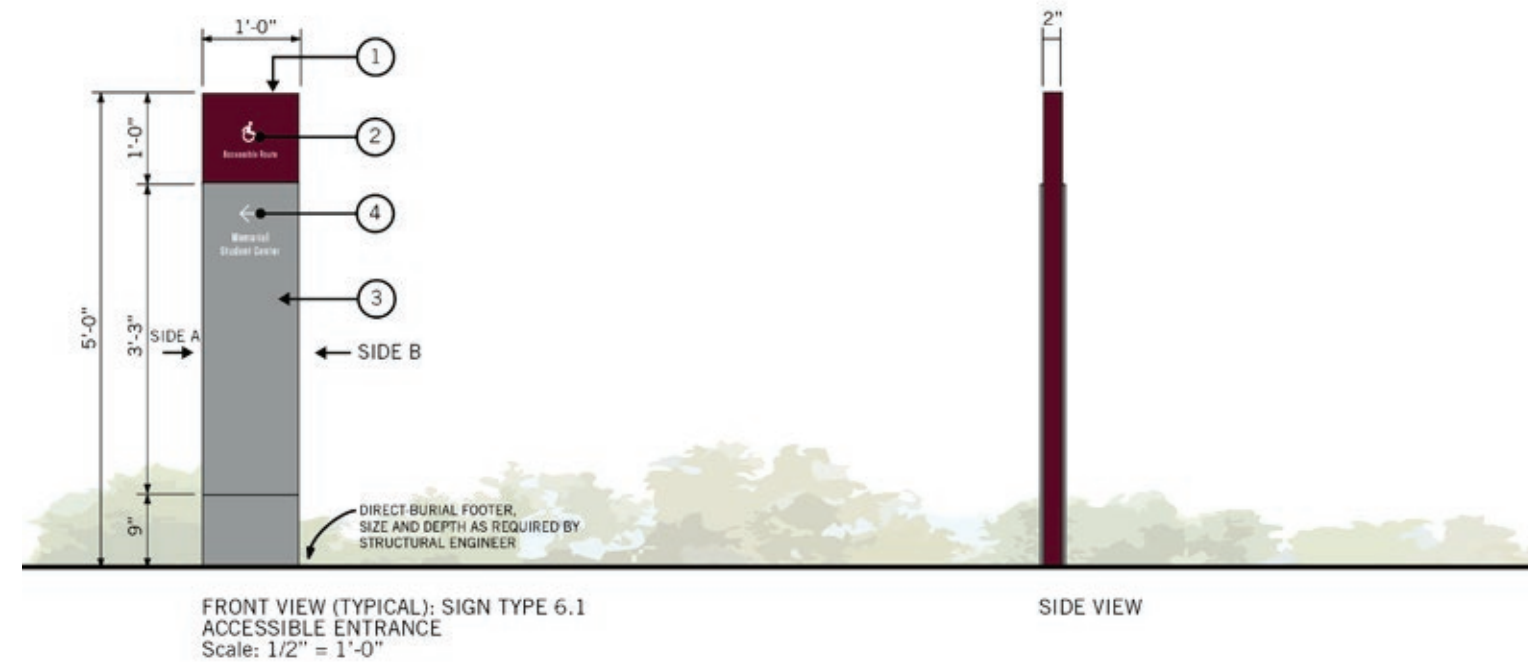





Educational and Specialty Signage

Educational Signage

Educational signs and plaques are used to communicate unique aspects of both the natural and built environments of the campus. Educational Signage should be displayed to educate campus users about sustainable features, energy consumption, campus history, and academic and research initiatives. Tied to the guiding principle of 'Utilizing the Campus as a Living Laboratory,' signage can create connections between innovative campus initiatives and campus users. The rainwater collection system at the Agriculture and Life Sciences Building and the rain gardens at the Mitchell Physics Building and Interdisciplinary Life Sciences Building (ISLB) are prime examples of locations for this type of signage to educate about stormwater management practices on campus. Signage should be placed directly adjacent to the feature it is illustrating. The template for this signage system is available through the Office of the University Architect, and the content, location and design must be approved by the Council for the Built Environment, the Office of the University Architect, and Marketing and Communications.

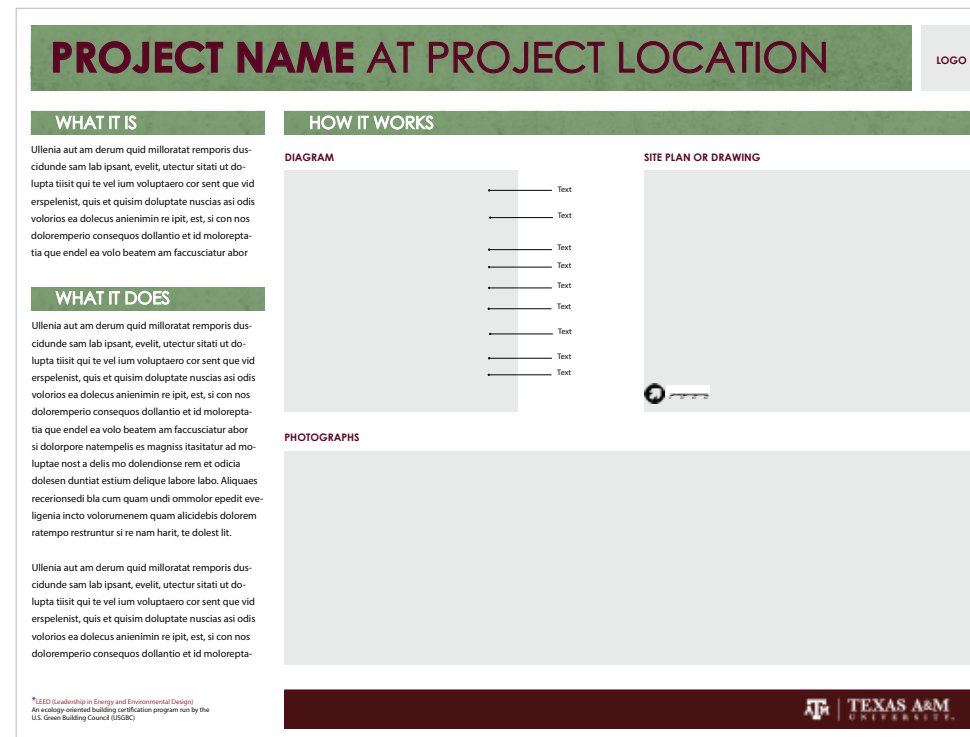

Educational Signage- Example Template



ISLB Rain Garden



Mitchell Physics Building Rain Garden



Agriculture and Life Sciences Building



Educational Signage- National Aquarium

Heritage

In celebration of the 125th anniversary of the campus, architecturally and culturally significant buildings were marked to recognize the historical buildings and their significance for the campus through the Campus Remembered program. Campus Remembered plaques should remain on all Level 1 – Heritage Buildings. All Level 1 buildings to receive Heritage designation should receive a bronze plaque. Location of the plaque must be approved by the Design Review Sub-Council and consistent with the existing bronze Campus Remembered plaque locations. Design material and content of any new designation plaque to be consistent with Campus Remembered plaques. Texas Historical Markers are used to commemorate diverse topics in Texas History. These signs are submitted through local County Historical Commission. All Historical Markers should be single post mounted. Location of the markers must be approved by the Design Review Sub-Council. *Guidelines for Historic Structures can be found in Chapter Seven Heritage Conservation.*

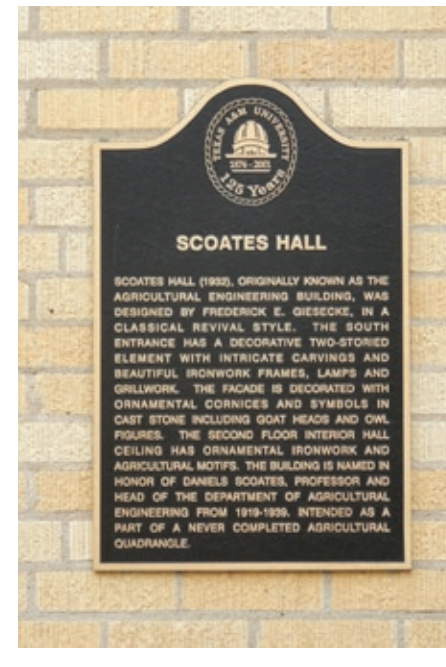

Campus Remembered Plaque - Scoates

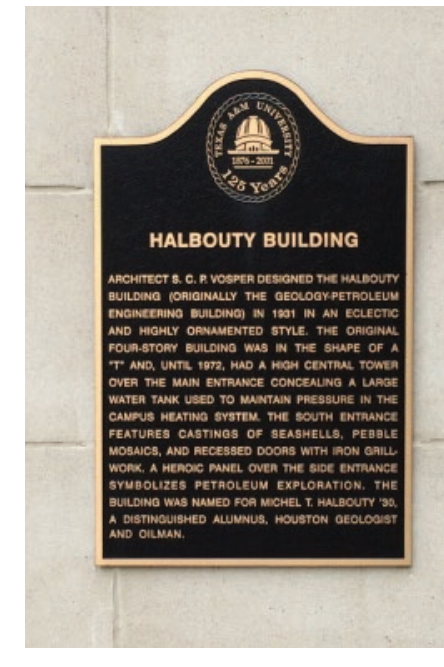

Campus Remembered Plaque - Halbouty



Example Historical Marker in Site

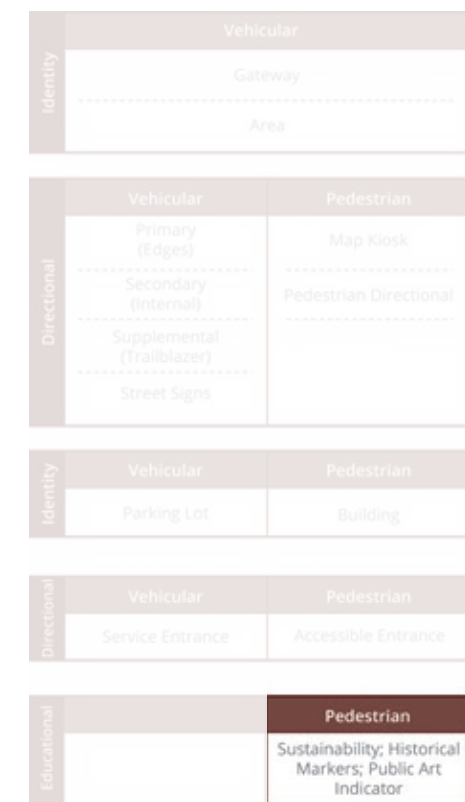

Sign Type Hierarchy Diagram

Specialty

Specific projects or areas of campus may be appropriate for specialty signage that falls outside of the signage system contained in this chapter. The Gardens at Texas A&M project is a prime example of this signage type. The Gardens is a 40-acre area that contains public teaching gardens and greenways focused on expanding Texas A&M's research and outreach including themed teaching gardens, an outdoor classroom, an event lawn, vineyard, grand arbor and pavilion. The specialty signage, pictured below, is unique to the signage system planned for the campus, but give the gardens its unique identity on the campus. The signs should be used very sparingly, to not confused the overall branding initiatives of the University. As these signs do not fit within the signage system included in this chapter, the content, location and design must be approved by the Design Review Sub-Council.



Specialty Signage at The Gardens

Commercial, Temporary and Miscellaneous Signs

To provide a consistent signage plan and brand for Texas A&M University, exterior-facing building signage is discouraged on the campus. Exterior-facing building signage includes:

- Graphic signage on exterior windows, doors and storefront glass systems
- Large exterior banners attached to building facades

Facade Graphics

To provide a consistent signage plan for Texas A&M University, exterior-facing commercial signage (those specifically intended to be viewed by the general public), other than outlined in these recommendations, is not permitted on the university campus. Exceptions may occur within the Athletics and Recreation, as the Department of Intercollegiate Athletics, which has the most need for graphic signage exposure as per agreements with media. Interior-facing graphic signage is left to the discretion of the department that occupies those facilities.



Graphic Signage placed at the Davis Player Development Center

Banners

Banners are temporary signage that are used to denote short term special events hosted by internal groups on campus.

Location and design must be approved by Marketing and Communications and the Office of the University Architect in conjunction with the facility manager and/or building proctor. Banner placement must not create a safety hazard in its placement.

The duration of the display is limited to 14 consecutive days, unless otherwise approved by Marketing and Communications or the Office of the University Architect.

Light poles banner are acceptable but must adhere to the following guidelines:

- Banner size for safety reasons should not exceed the recommended size per engineering evaluations for that specific install location with a do not exceed limit of 32" x 96"
- Banners should be printed on both sides
- Graphic design should be approved by Marketing and Communications. Approval form coordinated through Marketing and Communications

Architectural Lettering

Building Naming

Moving forward, on-building signage should be limited only to building names that are associated with donor names and agreements for funding the building directly. For example, the 'George P. & Cynthia Woods Mitchell Institute for Fundamental Physics and Astronomy' is acceptable to be placed directly on the building.

Buildings with no donor name associated in their naming are not permitted to place the name of the building directly on the building. These buildings are limited to using the building identification signage (Signage Types 5.1 and 5.2) only. Examples of this are the 'Liberal Arts and Arts & Humanities Building' and the 'Physical Education Activities Building'. Placing the name of a program or department on a building or building identification signage is not permitted. Academic programs and administrative units relocate buildings often, leaving signage out of date. Department names should be placed on directory signage within interior lobbies or vestibules at a building's main entrance.

When permitted on new construction, the building architect should use the graphic standard and incorporate a suitable location into the façade design. The building name may be centered over an entrance, or centered or left justified on an open wall either next to an entrance or visible from a key view.

Sign Types 7.1, 7.2, 7.3 - Architectural Lettering

General Specifications:

1. Fabricated 12" tall and 1" deep aluminum letters, horizontal brush finish w/ clear coat
2. Fabricated 15" tall and 1.5" deep aluminum letters, horizontal brush finish w/ clear coat
3. Fabricated 18" tall and 2" deep aluminum letters, horizontal brush finish w/ clear coat

Design Criteria:

- Lettering shall be Tungsten Medium with 150 pt. kerning
- Navigational aid to Key Destinations
- Letters shall be stud-mounted flush to wall surfaces

Location Criteria:

- Placed in locations of high visibility or viewable from long distances



Graphic Standard for Architectural Lettering

For level one Heritage Buildings or level two Historic Buildings, no on-building signage is permitted unless it is original to the building. Donor recognition should be placed on a stone monument adjacent to the main entrance. Monuments should be no more than 4' tall (including base and top cap) and lettering should align with the standards specified below. For Level 1 Heritage and Level 2 Historic buildings, both on-building sign removal and donor sign placement should conform to the guidelines in Chapter Seven Conversation Heritage.



Photo Rendering of Architectural Lettering at Rudder Tower



Donor Recognition Stone Monument at the H.J. (Bill) and Reta Haynes Engineering Building (formally known as the Civil Engineering Building)



Architectural Lettering on Coke Building



On-Building Signage at Mitchell Physics Building



On-Building Signage at Physical Education Activity Building



On-Building Signage at Liberal Arts and Humanities Building

NOMENCLATURE AND CONTENT

Advance Wayfinding

Advance wayfinding information inspires confidence, reduces anxiety, and helps visitors navigate a new place more quickly and efficiently. Once arriving at a destination, the system of signs and messages reinforce this objective. Wayfinding begins before a visitor arrives at a destination, and signage is only one tool in the wayfinding continuum of experiences and information that guides people to points of interest.

Web sites, print collateral, event advertising, and personal conversations are other examples of wayfinding tools that help guide audiences before they arrive to a campus.

On-Campus Wayfinding

On-campus wayfinding information is designed for first time or infrequent visitors. Signs cannot and should not list every possible destination. This would result in confusion and illegibility, especially for those first-time visitors, looking for the highest level of information only. Therefore, a hierarchy of destinations is applied to Texas A&M University's wayfinding

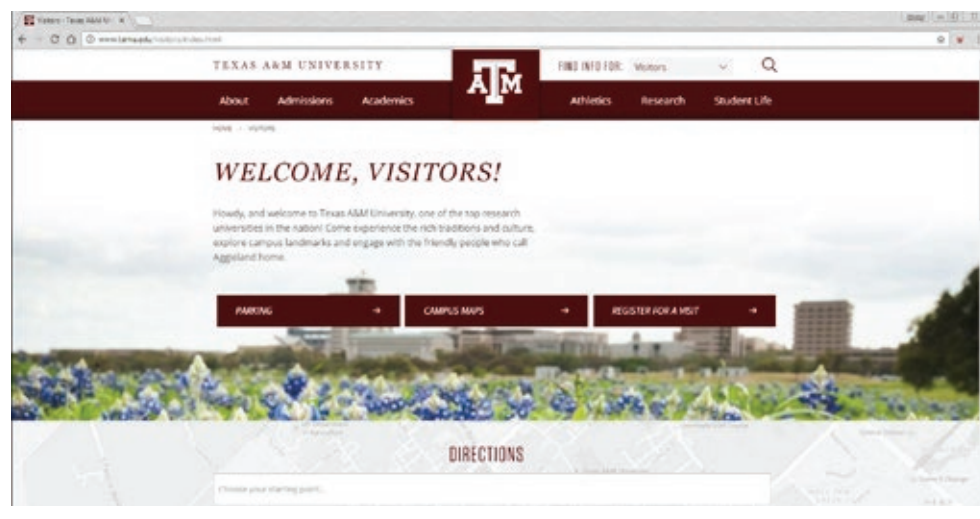

Texas A&M visitor webpage is an example of advance wayfinding

program, based on the importance to visitors, new students, and community. The system of signs and messages reinforces the institutional brand while delivering clear and simple navigational guidance.

Messaging

Members of the Design Team, Steering Committee, and Senior Leadership carefully devised a methodology for the messaging displayed on campus signage. In all cases, it is assumed that the target audience for vehicular and pedestrian signage will be first-time visitors or those uninitiated or unfamiliar with campus. Vehicular signage text will be limited to 6 lines. For pedestrian signage, the limit is 10 lines. Therefore, it is critical to prioritize information for display.

Because visitors arriving by vehicle are seeking restriction-free parking in proximity to the final destination, emphasis should be placed on directing to the on-campus parking garages and public surface lots.

If additional space remains, vehicular signs may display the names of proximate campus buildings that are likely visitor destinations. Vehicular signs should display only the names of buildings that have not already been passed. Key destinations that have an obvious public interface (e.g., J.K. Williams Administration Building, West Campus Library, Kyle Field, George Bush Presidential Library) or are a destination where a visitor might obtain important services (e.g., Memorial Student Center, Campus Safety, General Services Complex) were identified by the Steering Committee as appropriate to be placed on vehicular signage.

Similar priorities are established for pedestrian signage. Similar to vehicular signage, pedestrian signage will prioritize building identification for those buildings most likely to attract first-time visitors to campus. The goal is not to list every building name on each sign; rather, it is to help those unfamiliar with campus navigate unintuitive routes to key destinations.

Primary Vehicular Destinations

Emphasis should be placed on directing to the on-campus parking garages and public surface lots.

If additional space remains, vehicular signs may display the names of proximate campus buildings that are visitor destinations.

- *Central Campus Garage*
- *University Center Garage*
- *Northside Garage*
- *West Campus Garage*
- *Cain Parking Garage*
- *Lot 51 (adjacent to Emerging Technologies Building)*
- *Lot 72 (adjacent to West Campus Library)*
- *Bonfire Memorial*
- *Kyle Field*
- *Memorial Student Center*
- *Reed Arena*
- *Rudder Tower*
- *Rudder Theatre Complex*
- *Aggie Soccer Stadium*
- *Olsen Field*
- *Aggie Softball Complex*
- *Anderson Track and Field Complex*
- *Mitchell Tennis Center*
- *Student Recreation Center*
- *George Bush Presidential Library and Museum*
- *Annenberg Presidential Conference Center*
- *Texas A&M Veterinary Medicine Complex*
- *General Services Complex*
- *Health Sciences Center*
- *Koldus Building*
- *Memorial Student Center*

Primary Pedestrian Destinations

Pedestrian signage should prioritize building identification for those buildings most likely to attract first-time visitors to campus. The goal is not to list every building name on each sign; rather, it is to help those unfamiliar with campus navigate unintuitive routes to key destinations.

- *Bonfire Memorial*
- *Kyle Field*
- *McFerrin Athletic Center*
- *Memorial Student Center (MSC)*
- *Reed Arena*
- *Rudder Tower*
- *Rudder Theatre Complex*
- *Aggie Soccer Stadium*
- *Olsen Field*
- *Aggie Softball Complex*
- *Anderson Track and Field Complex*
- *Mitchell Tennis Center*
- *Student Recreation Center*
- *George Bush Presidential Library and Museum*
- *Annenberg Presidential Conference Center*
- *Texas A&M Veterinary Medicine Complex*
- *Appelt Aggeland Visitor Center*
- *Prospective Student Center*
- *J. Wayne Stark University Center Galleries*
- *Lettermen's Association Athletic Sports Museum*
- *Evans Library*
- *Clayton Williams Alumni Center*
- *Texas A&M Foundation John L. Hagler Center*
- *Sam Houston Sanders Corps of Cadets Center*
- *Research Park*
- *General Services Complex*
- *University Police Department*
- *Koldus Building*
- *Cushing Memorial Library & Archives*
- *Evans Library and Annex*
- *Military Walk*
- *West Campus Library*
- *Williams Administration Building*

SAMPLE TRIP: CUSHING LIBRARY & ARCHIVES

This sample trip illustrates the experience one would encounter while visiting campus to access the Cushing Library & Archives.

Visitors would be directed to park in Visitor Parking Lot P5, which can be accessed via New Main Drive and Bizzell Street as shown in the diagram below. Subsequent diagrams illustrate the expected vehicular and pedestrian paths of travel and potential locations for directional and identification signage.

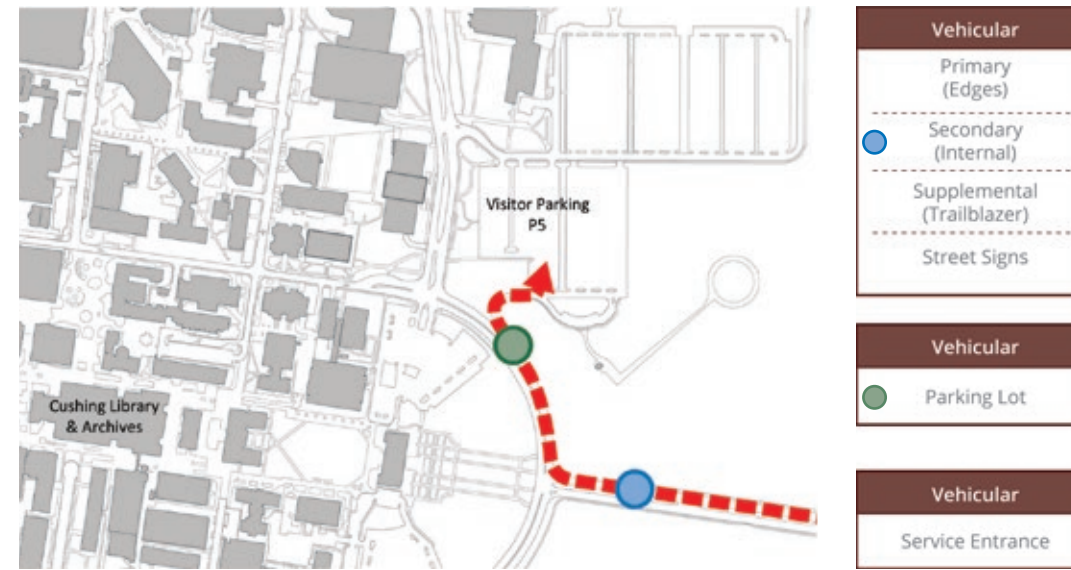

Vehicular path of travel via New Main Drive



Campus arrival via New Main Drive and Bizzell Street

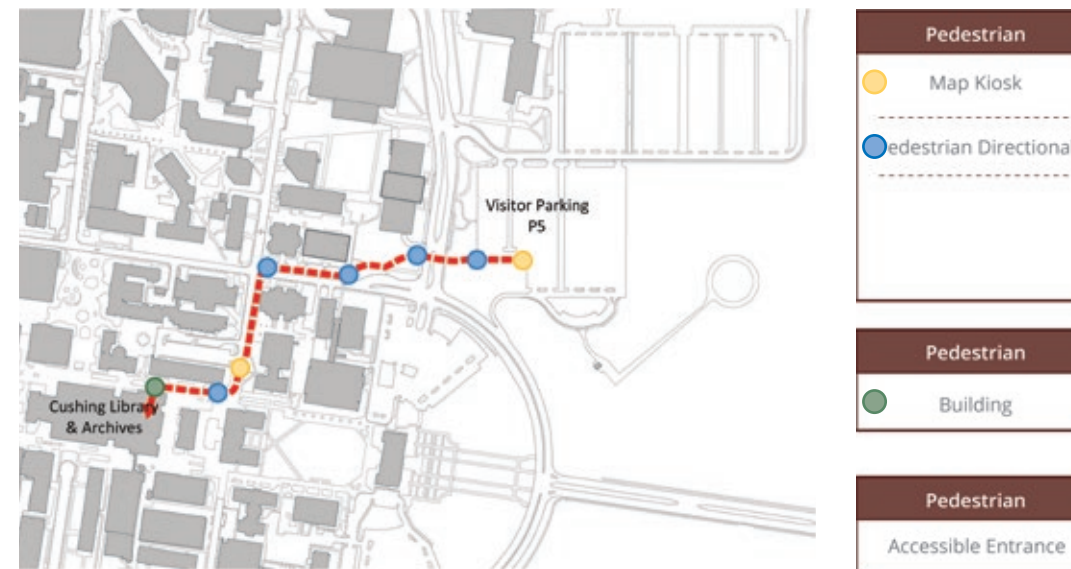

Pedestrian path of travel via lower portion of Visitor Lot P5

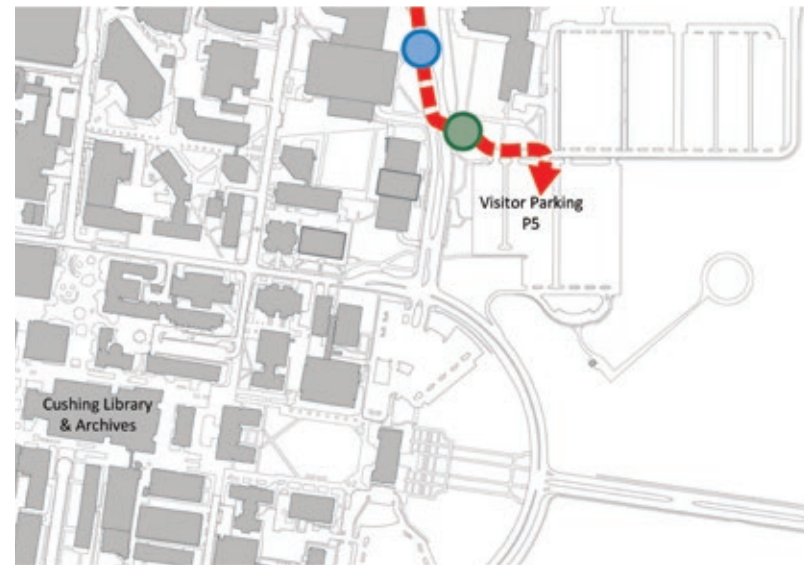

Vehicular	
Primary (Edges)	
Secondary (Internal)	●
Supplemental (Trailblazer)	
Street Signs	

Vehicular	
Parking Lot	●

Vehicular	
Service Entrance	

Vehicular path of travel via Bizzell Street

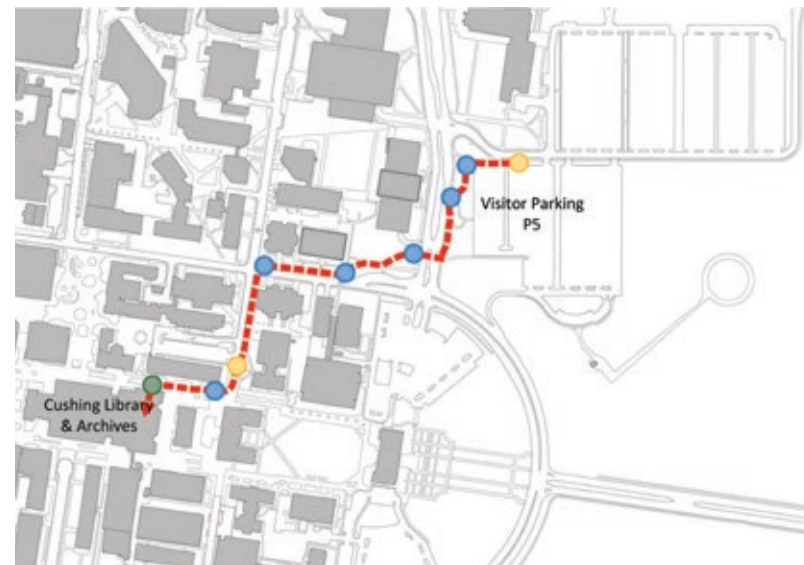

Pedestrian	
Map Kiosk	●
Pedestrian Directional	●

Pedestrian	
Building	●

Pedestrian	
Accessible Entrance	

Pedestrian path of travel via upper portion of Visitor Lot P5

SAMPLE TRIP: WEST CAMPUS LIBRARY

This sample trip illustrates the experience one would encounter while visiting campus to access the West Campus Library.

Visitors would be directed to park in the West Campus Garage (P2), which can be accessed via University Drive and George Bush Drive as shown in the diagram below. Subsequent diagrams illustrate the expected vehicular and pedestrian paths of travel and potential locations for directional and identification signage.

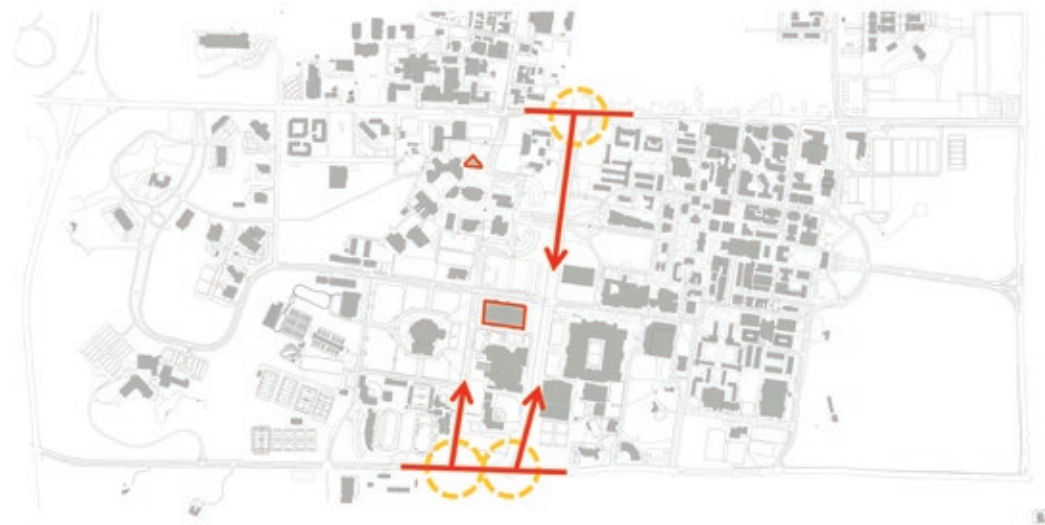

Campus arrival via University Drive and George Bush Drive

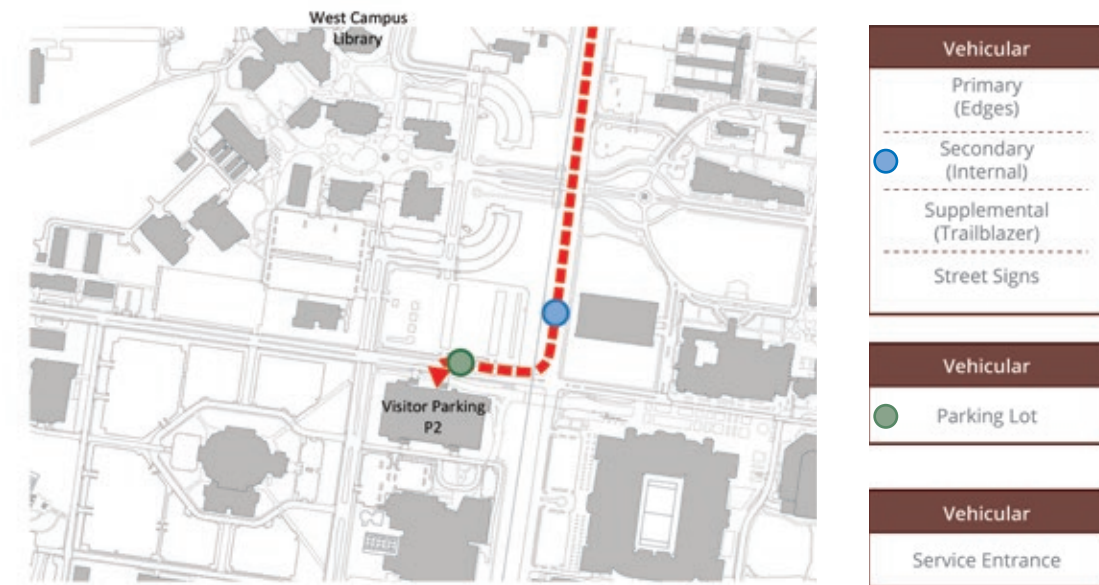

Vehicular path of travel via University Drive

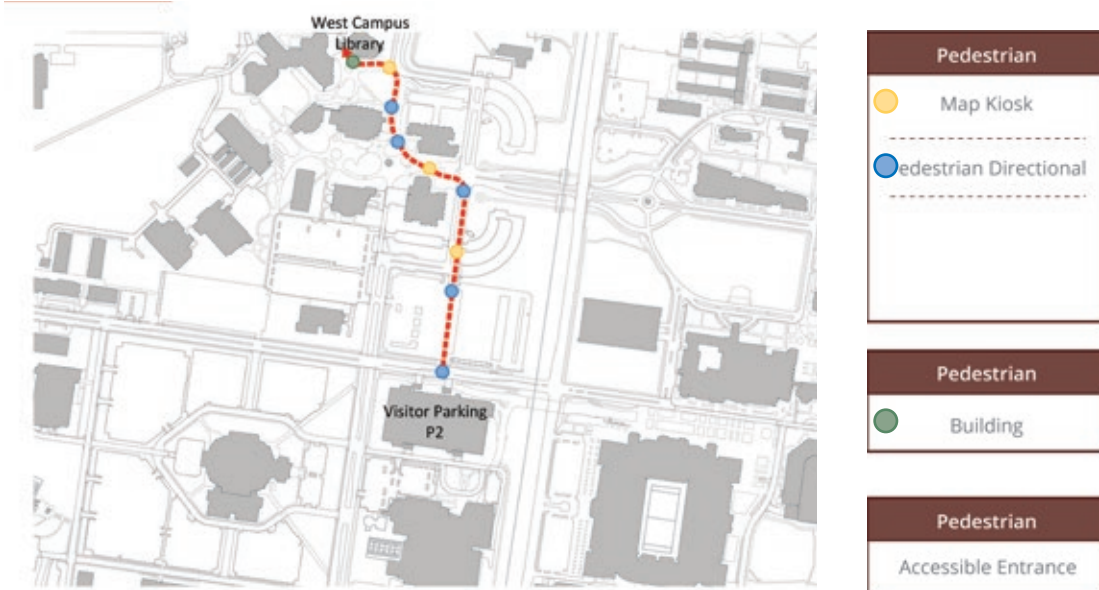

Pedestrian path of travel via West Campus Garage (P2)

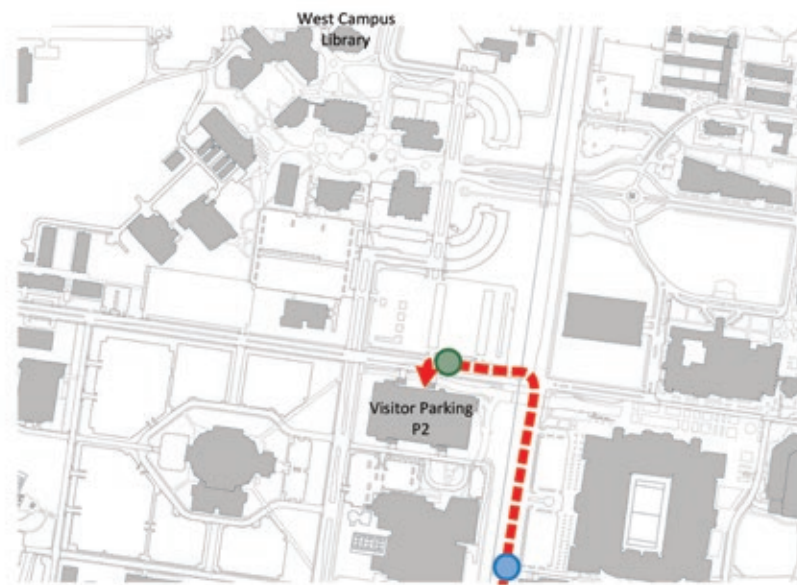

Vehicular
Primary (Edges)
Secondary (Internal)
Supplemental (Trailblazer)
Street Signs

Vehicular
Parking Lot

Vehicular
Service Entrance

Vehicular path of travel via George Bush Drive

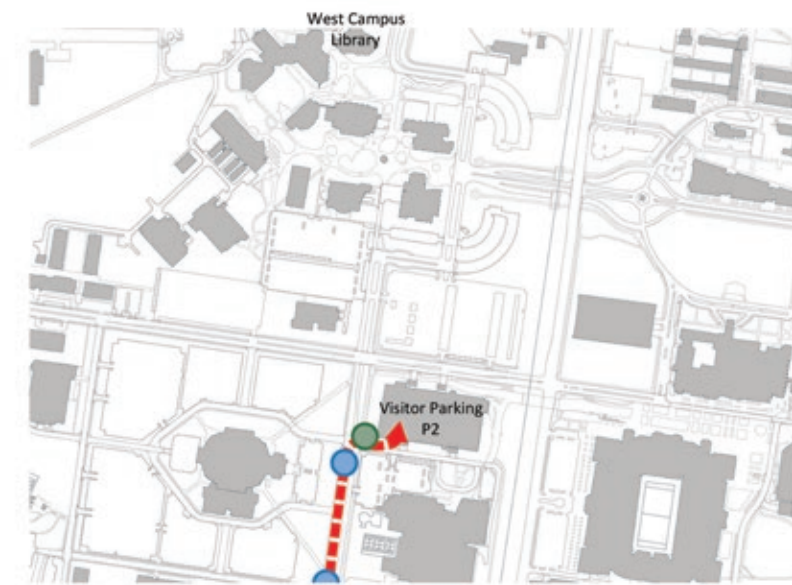

Vehicular
Primary (Edges)
Secondary (Internal)
Supplemental (Trailblazer)
Street Signs

Vehicular
Parking Lot

Vehicular
Service Entrance

Vehicular path of travel via George Bush Drive

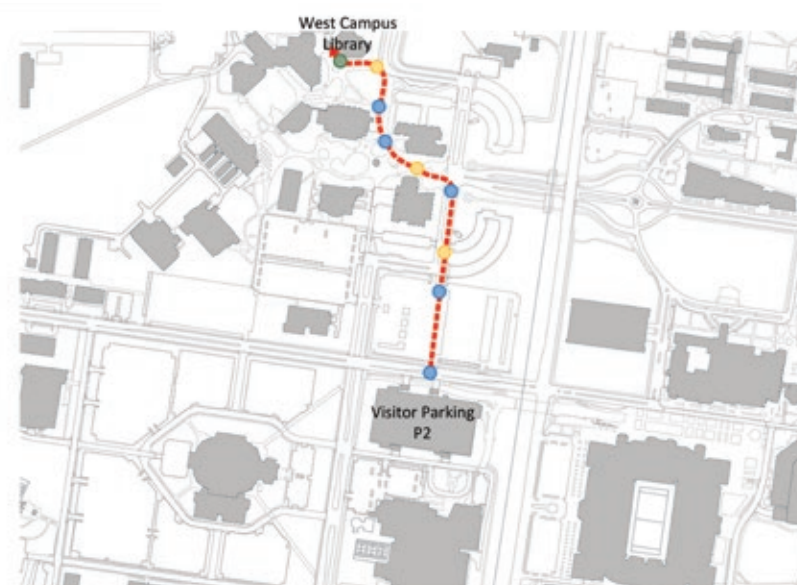

Pedestrian
Map Kiosk
Pedestrian Directional

Pedestrian
Building

Pedestrian
Accessible Entrance

Pedestrian path of travel via West Campus Garage (P2)

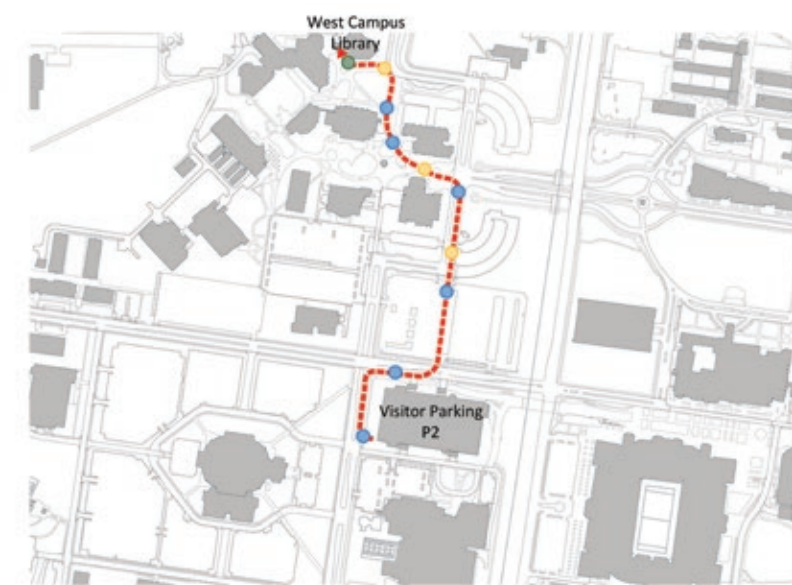

Pedestrian
Map Kiosk
Pedestrian Directional

Pedestrian
Building

Pedestrian
Accessible Entrance

Pedestrian path of travel via West Campus Garage (P2)

IMPLEMENTATION AND PHASING STRATEGY

Implementation

Once in place, the new campus signage system will provide seamless navigation across all parts of campus and create an overall sense of place for campus users and first time visitors. Because of the size and complexity of the campus, implementation will likely occur in tangent between two series of events:

1. Project-Based: Implementation is led by and funded directly through a project - such as new construction, building additions, major renovations, utility/infrastructure updates, landscape projects, or similar. This approach includes the replacement of, or addition to, campus signage over multiple signage systems.

Signage is to be included as part of the project budget and schedule, and should include the determination of sign types needed, quantity, placement and messaging, production, and installation of new campus signage standards with oversight from the Council for the Built Environment, Office of the University Architect, Marketing and Communications, and Transportation Services.

2. Funding-Based: Implementation is associated with campus initiatives led and funded by Transportation Services, Marketing and Communications, Residence Life, University Architect, or others.

The project should include the determination of sign types needed, quantity, placement and messaging, production, and installation of new campus signage standards with oversight from the Council for the Built Environment, Office of the University Architect, Marketing and Communications, and Transportation Services.

Signage Systems	Submitted to Council for the Built Environment			Project-Based	Funding-Based
	<i>Responsibility for Sign Messaging and Content</i>			<i>Funded through Projects such as New Construction, Additions, Major Renovations, Utility/Infrastructure Updates, Landscape Projects, etc.</i>	<i>Campus initiatives funded by Transportation Services, Marketing and Communications, Residence Life, University Architect, or others.</i>
Vehicular Signs	Office of the University Architect	Marketing and Communications	Transportation Services	●	●
Pedestrian Signs				●	●
Building Identification Signs				●	●
Educational Signs				●	●
Architectural Lettering				●	

Signage Implementation Strategy

All signage projects, whether project or funding based, need to recognize their relation to the larger signage system and hierarchy when implementing the signage standards. Below, each system of signage is described as it may be implemented overtime:

System 1 - Vehicular Signs

The most capital-intensive component of the program includes the removal of all existing vehicular directional signs on campus. These signs would be replaced with a series of new vehicular directional signs and parking signs. Top Priority should be given to the campus perimeter, which defines and brands campus edges, helps to enhance the wayfinding system for visitors by navigating campus users to correct parking structures and surface lots.

System 2 - Pedestrian Signs

This component includes the removal of all existing pedestrian directional signs on campus. These signs would be replaced with a series of new pedestrian map kiosks and pedestrian directional signs.

System 3 - Building Identification Signs

Includes the removal of all building identification signs on campus. These signs would be replaced with a series of new building identification signs—appropriately scaled for each building type. Building types include Key Destinations, Residence Halls, and other academic and ancillary buildings. Accessible entrance directional signs would be implemented as a part of this phase.

System 4 - Educational Signs

Includes the addition of signs that express, illustrate, and educate campus users about sustainable features, energy consumption, campus history, and academic and research initiatives. The template for this signage system is available through the Office of the University Architect, and the content, location and design must be approved by the Council for the Built Environment, the Office of the University Architect and Marketing and Communications.

System 5 - Architectural Lettering

Includes the removal of building-mounted lettering on campus, with the exception of original lettering on Level 1 - Heritage, Level 2 - Historic and Level 3 - Secondary Historic building. Architectural lettering should be replaced with a series of new building architectural lettering—appropriately scaled for each building type that aligns with signage standards.

Bonfire Memorial ►



Next Steps

The services of an experienced design firm with specific University campus experience will help shepherd the University through the immediate next steps. Well documented and specified projects streamline fabrication, limit costs arising from change orders, and increase the accuracy of bids for any aspects of the job not produced by the University.

This Chapter creates the framework by which a new signage program may be implemented campus-wide and is the first major milestone to full implementation. In order to achieve full implementation, the University will have to complete additional steps:

Design Intent Documentation and Specifications

Well documented and specified projects streamline fabrication, limit costs arising from change orders, and increase the accuracy of bids (for any aspects of the job not produced by the University.) This imperative step determines how the sign system can be built, installed, and updated by the University or a qualified vendor.

The sign types included in this chapter provide the aesthetic vision for the new signage standards. In order to begin signage fabrication and installation, the University must complete Design Intent Documentation and Specifications to describe the technical details as they relate to appropriate hardware, connections, locations and installation process, etc. A vendor would use these documents as a basis for creating shop drawings.

Signage Placement and Messaging Plan

Sign “programming” describes the system of specific sign locations and the types of information they convey. As the University begins to implement the installation of new signage locations and messages will have to be determined. The Nomenclature and Content and Sample Trips included in this chapter acts as a guide to determine message and locations.

As part of the established University process, all signage projects, either through a project-based or a funding-based approach, will be reviewed by the Council for the Built Environment. The Office of the University Architect and Marketing and Communications will oversee messaging and locations for all new signage. In addition, Transportation Services will oversee the messaging and locations for all vehicular signs, and map kiosks. The Sign Location Plan and Message Schedule are incorporated into Design Intent documents for use in accurately messaging and installing signs.







09

APPENDIX

Council for the Built Environment Process and Procedures
References and Resources
Acknowledgments
Focus Groups
Engagement
Campus Planning Team

COUNCIL FOR THE BUILT ENVIRONMENT PROCESS AND PROCEDURES

The Council for the Built Environment (CBE) was established in 2002 to ensure the physical campus supports the university's core missions of teaching, research and service. The CBE's goal is to provide a safe, secure, and functional learning and working environment as well as to create one that supports future growth and inspires learning and discovery.

The CBE makes recommendations to the president on all aspects of the campus built environment in support of the university's core mission of teaching, scholarship and research, and engagement as well as supports the realization of the goals contained in Vision 2020 and Action 2015: Education First. The Council advises on items including, but not limited to:

- Policies and plans supportive of development of a built environment that enables and enhances the university's ability to support its mission as well as make progress toward the goals of Vision 2020
- Prioritization, location, and funding of new construction
- Methods of acquisition and financing of additional facilities
- Prioritization of usage of existing space, renovation plans, and use of off-campus facilities
- Support of and information to the Master Planning process
- Prioritization of plans for campus regular and deferred maintenance

Four standing sub-councils report to the CBE: Design Review, Facilities Utilization and Planning, Technical Review, and Maintenance Review, the permanent manifestation of the previous Task Force on Deferred Maintenance. The sub-councils' purpose is to research and provide expertise to the CBE in formulating their recommendations to the President on decisions impacting the built environment of Texas A&M University.

The CBE generally receives three types of request: requests for space, request for construction or renovation, and request for the installation of artwork or a campus feature.

Space Request: When space becomes available on campus, the CBE Co-chairs issue a memorandum to all applicable parties inviting them to request space. Requests are submitted in writing to the CBE Co-Chairs, routed through the appropriate dean or vice president.

Construction: Generally, a user sends a written request to the CBE Co-Chairs, routed through the appropriate dean or vice president. The Co-Chairs assign the request to the appropriate Track.

- Track A is routed through the Council for the Built Environment to the University President. The appropriate Sub-Council(s) review and research the request, schedule presentations from the requesting party(ies), and vote on recommendations which are then presented to the CBE. The CBE then reviews the requests, the Sub-Council(s) recommendations, then votes to on a recommendation for the President to consider. The CBE then forwards their recommendation to the President for final approval or rejection.
- Track B is routed through the University Architect. The appropriate Sub-Council(s) review and research the request, schedule presentations from the requesting party(ies), and vote on recommendations. The University Architect evaluates the Sub-Council(s) recommendations and approves or rejects the request. The University Architect informs the CBE, and the CBE Co-Chairs inform the University President.

Public Art: All requests for public art must adhere to the TAMU Procedures for Public Art. Generally, a user sends a written request to the CBE Co-Chairs, routed through the appropriate dean or vice president. The Co-Chairs assign the request to the appropriate Sub-Council(s) for review. The Sub-Council(s) research the request, schedule presentations from the requesting party(ies) as appropriate, and vote on recommendations to present to the CBE. The assigned Sub-Council(s) reports their recommendation to the CBE. The CBE then reviews the requests, the Sub-Council(s) recommendations, then votes to on a recommendation for the President to consider. The CBE then forwards their recommendation to the President for final approval or rejection.

For more information about the Texas A&M University Council for the Built Environment visit <http://cbe.tamu.edu/>

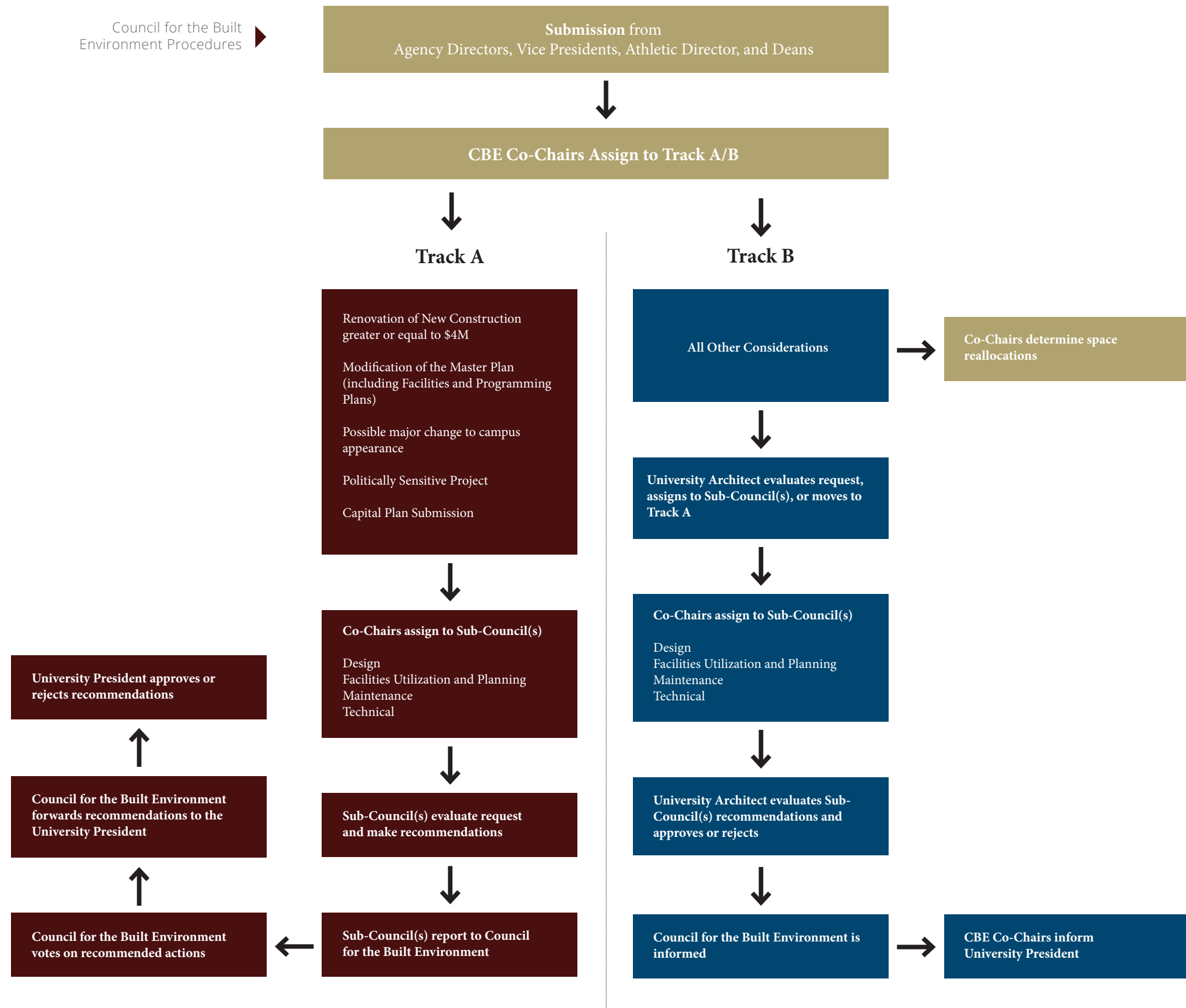

REFERENCES AND RESOURCES

This campus master plan update exists within the context of a large number of existing planning documents created to support Texas A&M University's future development. These documents are referenced both explicitly and implicitly in the text and hierarchy amongst the documents is established where appropriate.

Chapter One – Introduction

Texas A&M University. (2011, December 30). Master Development Plan for the Texas A&M Equine Initiative. Retrieved from <http://universityarchitect.tamu.edu/media/579486/EquineInitiative.pdf>

Texas A&M University. (2009). Texas A&M University Academic Master Plan. Retrieved from http://provost.tamu.edu/initiatives/academic-master-plan/AMP_DRAFT_092409_MASTERrev.pdf

Texas A&M University. (2015). Texas A&M University Agricultural & Environmental Life Sciences Center Masterplan. Retrieved from <http://universityarchitect.tamu.edu/media/579444/AgricultureMasterPlan.pdf>

Texas A&M University. (2013, August 27). Texas A&M University Athletic Facilities District Plan. Retrieved from <http://universityarchitect.tamu.edu/media/579447/Athletics.pdf>

Texas A&M University. (2007, August). Texas A&M University Campus Student Housing Master Plan – Residence Halls. Retrieved from http://universityarchitect.tamu.edu/media/579453/CampusStudentHousingMasterPlan_ResHalls.pdf

Texas A&M University. (2007, August). Texas A&M University Campus Student Housing Master Plan – University Apartments. Retrieved from http://universityarchitect.tamu.edu/media/579450/CampusStudentHousing_UnivApts.pdf

Texas A&M University. (2004). Texas A&M University Campus Master Plan. Retrieved from <http://vpfa.tamu.edu/files/presentations/2004MasterPlanFull.pdf>

Texas A&M University. (2013, June). Texas A&M University College of Veterinary Medicine & Biomedical Sciences Campus District Plan. Retrieved from <http://universityarchitect.tamu.edu/media/579489/CVMBS.pdf>

Texas A&M University. (2012, August). Texas A&M University Corps District Plan. Retrieved from <http://universityarchitect.tamu.edu/media/579456/CorpsOfCadets.pdf>

Texas A&M University. Texas A&M University Gardens and Greenway. Retrieved from <http://universityarchitect.tamu.edu/media/579459/GardensandGreenway.pdf>

Texas A&M University. Texas A&M University Health and Kinesiology District Plan. Retrieved from <http://universityarchitect.tamu.edu/media/579462/HealthandKinesiology.pdf>

Texas A&M University. (2008, January). Texas A&M University Health Science Center Campus Master Plan and Design Guidelines. Retrieved from <http://universityarchitect.tamu.edu/media/579468/HSCMasterPlan.pdf>

Texas A&M University. (2007, December). Texas A&M University Historic Core District Plan. Retrieved from <http://universityarchitect.tamu.edu/media/579465/HistoricCoreDistrictPlan.pdf>

Texas A&M University. (1999). Vision 2020: Creating a Culture of Excellence. Retrieved from <http://vision2020.tamu.edu/>

Texas A&M University. (2014, July). Texas A&M University West Campus Housing Connectivity Study. Retrieved from <http://universityarchitect.tamu.edu/media/755719/West%20Campus%20Connectivity%20Plan.pdf>

Chapter Two – Existing Conditions and Observations

Texas A&M University. (2004). Texas A&M University Campus Master Plan. Retrieved from <http://vpfa.tamu.edu/files/presentations/2004MasterPlanFull.pdf>

Texas A&M University. (2008, January). Texas A&M University Health Science Center Campus Master Plan and Design Guidelines. Retrieved from <http://universityarchitect.tamu.edu/media/579468/HSCMasterPlan.pdf>

Texas A&M University. (2016, April). 2016 Supplement Stormwater Management Plan. Texas A&M University: Author

Texas A&M University. (2012, March). Utilities and Energy Master Plan Update (Project 59391). Texas A&M University: Author

Chapter Three – Campus Development Plan

Texas A&M University. (2015). Texas A&M University Agricultural & Environmental Life Sciences Center Masterplan. Retrieved from <http://universityarchitect.tamu.edu/media/579444/AgricultureMasterPlan.pdf>

Texas A&M University. (2013, August 27). Texas A&M University Athletic Facilities District Plan. Retrieved from <http://universityarchitect.tamu.edu/media/579447/Athletics.pdf>

Texas A&M University. (2007, August). Texas A&M University Campus Student Housing Master Plan – Residence Halls. Retrieved from http://universityarchitect.tamu.edu/media/579453/CampusStudentHousingMasterPlan_ResHalls.pdf

Texas A&M University. (2007, August). Texas A&M University Campus Student Housing Master Plan – University Apartments. Retrieved from http://universityarchitect.tamu.edu/media/579450/CampusStudentHousing_UnivApts.pdf

Texas A&M University. (2004). Texas A&M University Campus Master Plan. Retrieved from <http://vpfa.tamu.edu/files/presentations/2004MasterPlanFull.pdf>

Texas A&M University. Texas A&M University Gardens and Greenway. Retrieved from <http://universityarchitect.tamu.edu/media/579459/GardensandGreenway.pdf>

Texas A&M University. Texas A&M University Health and Kinesiology District Plan. Retrieved from <http://universityarchitect.tamu.edu/media/579462/HealthandKinesiology.pdf>

Texas A&M University. (2008, January). Texas A&M University Health Science Center Campus Master Plan and Design Guidelines. Retrieved from <http://universityarchitect.tamu.edu/media/579468/HSCMasterPlan.pdf>

Chapter Four – Mobility

National Association of City Transportation Officials. (2013). Urban Street Design Guide. New York, NY.: Author.

Dill, J., McNeil, N. (2012). Four Types of Cyclists? Testing a Typology to Better Understand Bicycling Behavior and Potential (Working Paper). Retrieved from Portland State University website: http://web.pdx.edu/~jdill/Types_of_Cyclists_PSUWorkingPaper.pdf.

American Association of State Highway and Transportation Officials. (2012). Guide for the Development of Bicycle Facilities (Fourth Ed.). Washington, D.C.: Author

National Association of City Transportation Officials. (2013). Urban Bikeway Design Guide (Second Ed.). New York, NY.: Author.

Association of Pedestrian and Bicycle Professionals. (2010). Bicycle Parking Guidelines (Second Ed.).

International Code Council. (2015). International Fire Code (First Ed.). Washington, D.C.: Author.

Transportation Research Board. (2010). NCHRP 672 Roundabouts: An Informational Guide (Second Ed.). Washington, D.C.: Author.

Institute of Transportation Engineers. (2004). Parking Generation (Third Ed.). Washington, D.C.: Author.

Texas A&M Transportation Institute (n.d.). Transformational Mobility Study (Ongoing Study). College Station, TX.: Author

City of College Station. (2002, October). Bikeway and Pedestrian Master Plan Update. Retrieved from <http://www.cstx.gov/Modules/ShowDocument.aspx?documentid=3641>

Texas A&M University. (2015). Bicycle District Strategic Plan. Retrieved from <http://transport.tamu.edu/Alternative/bicycles/updates.aspx>

Texas A&M University. (2004). Texas A&M University Campus Master Plan. Retrieved from <http://vpfa.tamu.edu/files/presentations/2004MasterPlanFull.pdf>

Chapter Five - Sustainability and Wellness

Allen, G., MacNaughton, P., et al. (2015, October 26). Associations of Cognitive Function Scores with Carbon Dioxide, Ventilation, and Volatile Organic Compound Exposures in Office Workers: A Controlled Exposure Study of Green and Conventional Office Environments. Retrieved from <https://ehp.niehs.nih.gov/wp-content/uploads/advpub/2015/10/ehp.1510037.acco.pdf>

American Society of Landscape Architects, Inc. Sustainable Sites Initiative Website. <https://www.asla.org/sites/>

ASHRAE. (2013). ANSI/ASHRAE Standard 90.1-2013. Energy Standard for Buildings Except Low-Rise Residential Buildings. 2013, American Society of Heating, Refrigerating, and Air-Conditioning Engineers, Inc.: Atlanta, GA.

City of Bryan, City of College Station. (2009, February). Unified Stormwater Design Guidelines. Retrieved from http://www.bcsunited.net/2012_files/design_manual/2009/drainage_2009.pdf

United States Green Building Council, (2014) LEED Reference Guide for Green Building Design and Construction, 2009 Ed. Washington, D.C. United States Green Building Council

United States Green Building Council, (2013) LEED Reference Guide for Green Building Design and Construction, Version v4. Washington, D.C. United States Green Building Council

Texas A&M University. (2015). Energy Action Plan 2020. Retrieved from <https://utilities.tamu.edu/energy-action-plan-2020/>

Texas A&M University. (2010). Texas A&M University Diversity Plan. Retrieved from <http://diversity.tamu.edu/getattachment/Diversity-Plan/Diversity-Plan-2010.pdf.aspx>

Texas A&M University. (2014). Texas A&M University Utility & Energy Design Standards. Texas A&M University: Author

Texas A&M University. (2012, March). Utilities and Energy Master Plan Update (Project 59391). Texas A&M University: Author

United States Energy Information Administration. (2003). Commercial Buildings Energy Consumption Survey (CBECS). Retrieved from <https://www.eia.gov/consumption/commercial/data/2003/>

Wellman, K. (2015, January 23). 2015 Texas A&M University AASHE STARS Report. Retrieved from <https://stars.aashe.org/institutions/texas-am-university-tx/report/2015-01-23/>

Chapter Six – Campus Guidelines

State of Texas. (2003, February 1). Texas Revisions to the International Building Code. Retrieved from <https://archive.org/details/gov.tx.building>

The Texas Department of Licensing and Regulation. (2012). 2012 TAS Texas Accessibility Standards: Elimination of Architectural Barriers (Chapter 469). Retrieved from <https://www.license.state.tx.us/AB/2012TAS/2012tasComplete.pdf>

Texas A&M University. (2014). Texas A&M University Utility & Energy Design Standards. Retrieved from <https://utilities.tamu.edu/wp-content/uploads/2013/08/General-Outdoor-Lighting.pdf>

The United States National Arboretum. Native plant definition. Retrieved from <http://www.usna.usda.gov/Gardens/faqs/nativefaq2.html>

Chapter Seven – Heritage Conservation

National Park Service. (1997) National Register Bulletin: How to Apply the National Register Criteria for Evaluation. Retrieved from <https://www.nps.gov/nr/publications/bulletins/pdfs/nrb15.pdf>

National Park Service, Technical Preservation Services. (n.d.). The Secretary of the Interior's Standards. Retrieved from <https://www.nps.gov/tps/standards.htm>

Slaton, D. "The Preparation and Use of Historic Structure Reports." 43 Preservation Briefs, U.S. Government Printing Office, 2004, Washington, D.C. Retrieved from <https://www.nps.gov/tps/how-to-preserve/preservedocs/preservation-briefs/43Preserve-Brief-StructureReports.pdf>

State of Texas, Office of the Secretary of State. Texas Administrative Code (Title 13, Part 2, Chapter 26, Subchapter B, Rule 26.7). Retrieved from [http://texreg.sos.state.tx.us/public/readtac\\$ext.viewtac](http://texreg.sos.state.tx.us/public/readtac$ext.viewtac)

Chapter Eight – Signage and Wayfinding

Texas A&M University. (2016, August) Texas A&M University Style Guide. Retrieved from http://brandguide.tamu.edu/downloads/Texas_AM_Style_Guide_8.2016.pdf

ACKNOWLEDGMENTS

Texas A&M University System Board of Regents

Cliff Thomas – Chairman
Elaine Mendoza – Vice Chairman
Phil Adams
Robert L. Albritton
Anthony G. Buzbee
Morris E. Foster
Bill Mahomes
Judy Morgan
Charles W. Schwartz
Stephanie Y. Martinez – Student Regent

Texas A&M University System Executive Officer

John Sharp – Chancellor

Texas A&M University College Station Executive Committee

Michael K. Young – President
Dr. Karan L. Watson – Provost and Executive Vice President
Dr. Jerry R. Strawser – Executive Vice President and Chief Financial Officer

Campus Master Plan Co-Chairs

Lilia Gonzales, AIA, LEED AP – University Architect
Dr. Jorge Venegas – Dean of the College of Architecture

Council of Deans

Dr. Joyce Alexander – College of Education and Human Development
Dr. Meigan Aronson – College of Science
Dr. Katherine Banks – College of Engineering
David H. Carlson – University Libraries
Mark Welsh III – Bush School
Dr. Eleanor Green – College of Veterinary Medicine & Biomedical Sciences
Dr. Mark Hussey – College of Agriculture and Life Sciences
Dr. Eli Jones – Mays Business School
Dr. Cesar Malave – Texas A&M University at Qatar
Dr. Patrick Louchouart – Texas A&M University at Galveston
Dr. Jay Maddock – School of Public Health
Dr. Pamela Matthews – College of Liberal Arts
Dr. Debbie Thomas – College of Geosciences
Dr. Andrew Morriss – School of Law
Dr. Carrie Byington – Health Science Center
Dr. Indra Reddy – Irma Lerma Rangel College of Pharmacy
Dr. Jorge Vanegas – College of Architecture
Dr. Sharon Wilkerson – College of Nursing
Dr. Lawrence Wolinsky – Baylor College of Dentistry

Thousands of Aggies met at the Bonfire Memorial to participate in a candlelight vigil held at 2:42 AM, the exact time that the bonfire collapsed ten years earlier.



Council for the Built Environment - Advisory Committee

Ex-Officio Members

Dr. Karan L. Watson – Provost and Executive Vice President - Co-Chair
Dr. Jerry R. Strawser – Executive Vice President and Chief Financial Officer - Co-Chair
Lilia Gonzales – Chair of the Design Review Sub-Council
Tom Reber – Chair of the Technical Review Sub-Council
Dr. Marty Scholtz – Chair of the Facilities Utilization and Planning Sub-Council
Ralph Davila – Executive Director, Facilities and Dining Administration and Chair of the Maintenance Review Sub-Council
David Morrison – Director, Facilities Coordination
Deborah Wright – Associate Vice President, Budget and Planning
Kevin Hurley – Senior Associate Athletic Director for Facilities and Construction
Richard Gentry – Resident Regional Manager for Facilities Services

Appointed Members

Dr. N.K. Anand – Agencies
Dr. Bill Dugas - Agencies
Dr. Katherine Banks – Council of Deans
Dr. Eleanor Green – Council of Deans
Dr. Meigan Aronson - Council of Deans
Penny Riggs – Council of Principal Investigators
Dr. Victor Ugaz - Council of Principal Investigators
Dr. Jim Grau - Council of Principal Investigators
Dr. Mark Sicilio – Faculty Senate
Dr. Bob Strawser - Faculty Senate
Dr. Jose Fernandez-Solis - Faculty Senate
Bara Safarova - Graduate and Professional Student Council
Christian Nygren - Graduate and Professional Student Council
Hannah Wimberly – Student Government Association
Grace Dansby – Student Government Association
Joseph Benigno – Student Government Association
Christopher Lyons – Graduate Students
Andy Armstrong – University Staff Council
Rebecca Eaton - University Staff Council
Dr. Paul Odgen - Vice Presidents
Dr. Glen Laine – Vice Presidents
Dr. Daniel Pugh – Vice Presidents

Students gathering in
Memorial Student Center ▶



FOCUS GROUPS

Circulation and Transportation

Stuart Anderson – College of Engineering
Joseph Benigno – Council for the Built Environment, Student Government Association
Bill Cox – Facilities & Dining Administration
Dennis Corrington – Recreational Sports
Ralph Davila – Facilities and Dining Administration, Council for the Built Environment Maintenance Review Sub-Council
Madeline Dillard – Transportation Services
Maggie Guzman – Residence Life
Joseph Hernandez – Residence Hall Staff Council
Dr. Angie Hill Price – Transportation Services Advisory Committee
Debbie Hoffmann – Transportation Services
Therese Kuchera - Transportation Services
Peter Lange – Transportation Services
Dr. Tim Lomax – Texas A&M Transportation Institute
Bryan McBride – Resident Hall Association
Madison Metskee-Galaeza - Terxas A&M Transportation Institute
Christian Nygren – Council for the Built Environment, Graduate and Professional Student Council
Jeff Puckett - Transportation Services
Heather Quiram - College of Veterinary Medicine and Biomedical Sciences
Tom Reber – Council for the Built Environment Technical Review Sub-Council
Ron Steedly – Transportation Services
Bob Stawser – Transportation Services Advisory Committee
Michaela Thomas - College of Veterinary Medicine and Biomedical Sciences
Bob Warden - College of Architecture, Center for Heritage Conservation
Ward Wells – Council for the Built Environment Design Review Sub-Council
Douglas Williams – Transportation Services
Hannah Wimberly – Council for the Built Environment, Student Government Association

Design Guidelines

Stephen Caffey – Council for the Built Environment Design Review Sub-Council
Ralph Davila – Facilities and Dining Administration, Council for the Built Environment Maintenance Review Sub-Council
Dennis Gray – SSC Engineering, Design, and Construction Services
Cathy Hastedt – Council for the Built Environment Design Review Sub-Council
Ben Kalscheur - Office of Sustainability
Jeff Lednicki - Utilities and Energy Services
Rob Meyer - Utilities and Energy Services
Christian Nygren – Council for the Built Environment, Graduate and Professional Student Council
Michaela Thomas - College of Veterinary Medicine and Biomedical Sciences
Russ Wallace – Facilities, Planning & Construction
Kelly Wellman - Office of Sustainability
Ward Wells – Council for the Built Environment Design Review Sub-Council
Hannah Wimberly – Council for the Built Environment, Student Government Association
Erica Wozniak – Facilities and Dining Administration



◀ Game Day at Kyle Field

Hensel Park

Joseph Beningo – Council for the Built Environment, Student Government Association
Jennifer Boyle – Student Activities
Bill Cox - Facilities and Dining Administration
Don Crawford – SSC Grounds
Dr. John Crompton – Recreation, Parks & Tourism Science Department
Bruce Dvorak – Council for the Built Environment Design Review Sub-Council
Melissa McConnell - Residence Life
Rob Meyer – Utilities & Energy Services
Christian Nygren – Council for the Built Environment, Graduate and Professional Student Council
Dr. Scott Shafer – Recreation, Parks & Tourism Science Dept.
Dr. Doug Welsh - Agriculture and Life Sciences
Lynn Wiggs – Transportation Services
Hannah Wimberly – Council for the Built Environment, Student Government Association



◀ Texas A&M Armillary Sphere

Infrastructure

Stuart Anderson – College of Engineering
Julie Brown – Utilities & Energy Services
Ralph Davila – Facilities & Dining Administration, Council for the Built Environment Maintenance Review
Bob Henry – Utilities & Energy Services
Tyler Hjorth – Utilities & Energy Services
Dr. Harry Jones – Council for the Built Environment Design Review
Nathan Jones – Utilities & Energy Services
Peter Lange – Transportation Services
Rob Meyer – Utility & Energy Services, Council for the Built Environment Technical Review
Dan Mizer – Residence Life
Christian Nygren – Council for the Built Environment, Graduate and Professional Student Council
Mike Ragan – University Police Department, Council for the Built Environment Technical Review
Tom Reber – Council for the Built Environment Technical Review Sub-Council
Jim Riley – Utilities & Energy Services
Jane Schneider – Facilities and Operations
Dr. Marty Scholtz – Council for the Built Environment Facilities Utilization & Planning
Myron Walden – Information Technology
Bob Warden - College of Architecture, Center for Heritage Conservation
Doug Williams - Transportation Services
Les Williams – Utility & Energy Services
Clinton Willis - Transportation Services

Landscape Guidelines

Joseph Benigno – Council for the Built Environment, Student Government Association
Jonathan Carazos - SSC
Bill Cox – Facilities and Dining Administration
Don Crawford – SSC
Ralph Davila – Facilities & Dining Administration, Council for the Built Environment Maintenance Review Sub-Council
Bruce Dvorak – Council for the Built Environment Design Review Sub-Council
Seth Flowers - SSC
Joseph Johnson – Agriculture and Life Sciences
Melissa McConnell – Residence Life
Rob Meyer - Utilities and Energy Services
Forster Ndubisi – Council for the Built Environment Design Review Sub-Council
Dr. Doug Welsh - Agriculture and Life Sciences
Hannah Wimberly – Council for the Built Environment, Student Government Association
Lynn Wiggs - Transportation Services
Carla Wiseniske - SSC

Preservation and Adaptive Reuse

Greg Bailey – Council for the Built Environment Design Review Sub-Council
Bill Cox – Facilities and Dining Administration
Cathy Hastedt - Council for the Built Environment Design Review Sub-Council
Sarah Morris – SSC
Christian Nygren – Council for the Built Environment, Graduate and Professional Student Council
Michaela Thomas - College of Veterinary Medicine and Biomedical Sciences
Bob Warden – College of Architecture, Center for Heritage Conservation
Hannah Wimberly – Council for the Built Environment Student Government Association
David Woodcock – Center for Heritage Conservation



◀ Entrance to the Memorial Student Center

Research Park

Stuart Anderson – College of Engineering
Julie Brown – Utilities & Energy Services
Bill Cox - Facilities and Dining Administration
Matt Fry – Division of Research
Peter Lange – Transportation Services
Rob Meyer – Utility & Energy Services, Council for the Built Environment
Technical Review Sub-Council
Douglas Williams – Transportation Services



◀ George H. Bush
Presidential Library

Residence Life and Dining

Nicholas Carlson - Residence Hall Staff Council, Student
Andy Cronk – Chartwells Facilities
Ralph Davila – Council for the Built Environment Maintenance Review Sub-Council
Michael Garon – SSC Engineering, Design, and Construction Services
Matthew Grover – Garden Apartments, Student
Valerie Hadley – Facilities and Dining Administration
Aaron Harbaugh - Residence Life
Joseph Hernandez – Residence Hall Staff Council, Student
Dan Mizer – Residence Life
Bryan McBride – Residential Housing Association
Heather Quiram - College of Veterinary Medicine and Biomedical Sciences
Leland Rapport – Chartwells Vice President of Operations
Chareny Rydl - Residence Life
Jane Schneider – Facilities and Operations
Michaela Thomas - College of Veterinary Medicine and Biomedical Sciences
Jeff Wilson – Residence Life

Sustainability

Joseph Beningo – Council for the Built Environment, Student Government Association
Carol Binzer – Residence Life
Jonathan Cavazos - SSC
Bill Cox – Facilities and Dining Administration
Don Crawford – SSC
Bruce Dvorak - Council for the Built Environment Design Review Sub-Council
Ben Kalscheur – Office of Sustainability
Jane Schneider – Facilities and Operations
Philip Tabb – College of Architecture
Shannon Tipton – SSC Engineering, Design, and Construction Services
Michaela Thomas - College of Veterinary Medicine and Biomedical Sciences
Russ Wallace – System, Facilities, Planning & Construction
Kelly Wellman – Office of Sustainability
Hannah Wimberly – Council for the Built Environment, Student Government Association
Carla Wiseniske - SSC

Voices of the Campus

Dr. RJ Adams – Executive Committee of Distinguished Professors
Dr. Helene Andrews-Polymenis – Council of Principal Investigators
Andy Armstrong – University Staff Council
Joseph Benigno – Student Government Association
Dr. Leonard Bierman – Faculty Senate
Joseph Hood – Student Senate
Alyssa Michalke - Corps of Cadets
Aaron Mitchell – Student Senate
Dr. B. Don Russell – Executive Committee of Distinguished Professors
Cecille Sorio – Corps of Cadets
Doug Sweet – University Staff Council
Bob Strawser – Faculty Senate
Paul Taele – Graduate & Professional Student Council
Hannah Wimberly – Council for the Built Environment, Student Government Association



◀ Appelt Aggieland Visitors Center

Wayfinding and Signage

Bill Cox – Facilities and Dining Administration

Dr. Tracey Forman – Disability Services

Matt Fry – Division of Research

Richard Gentry – SSC

Michael Green – Marketing and Communications

Peter Lange – Transportation Services

Melissa McConnell - Residence Life

Dan Mizer – Residence Life

David Morrison – Facilities Coordination

Heather Quiram - College of Veterinary Medicine and Biomedical Sciences

Autumn Redman – SSC Graphics

Health Science Center

Dr. Clay Hanks, Texas A&M Health Science Center

Game Day at
Kyle Field ▶



ENGAGEMENT

Campus and Community Engagement

Student Senate

University Staff Council

Faculty Senate

Transportation Services Advisory

Brazos County Intergovernmental Committee

Bryan College Station Metropolitan Planning Organization Policy Committee

Bryan College Station Metropolitan Planning Organization Technical Advisory Committee

Faculty and Staff Open Forum

Student Open House

Brazos County Intergovernmental Committee

Office of the University Architect and Others

Lilia Gonzales, AIA, LEED AP - University Architect

Terry Roye, AIA - Project Architect

Hannah Ortolon - Graduate Assistant Non-Teaching

Saima Musharrat - Graduate Assistant Non-Teaching

Ashley Skow - Administrative Coordinator

Karen Bigley - Communications Manager

Jason Schubert

Texas A&M University System

Russ Wallace - Executive Director, Facilities, Planning and Construction

Pete Schmidt - Director, Facilities, Planning and Construction

Yvonne Bryant - Project Planner

CAMPUS PLANNING TEAM

Lead Consultant

Ayers Saint Gross

Site and Landscape Consultant

Coleman & Associates

Mobility and Transportation Consultant

DeShazo Group

Historic Preservation Consultant

Quimby McCoy Preservation Architecture

Civil Engineering Consultant

JQ Engineering

Sustainability Consultant

MEP Associates

Ayers Saint Gross

Infrastructure Consultant

Shah Smith

Cost Consultant

Vermeulens

Signage and Wayfinding Consultant

Ayers Saint Gross

Space Analytics Consultant

Ayers Saint Gross

Albritton Bell Tower
at Sunset





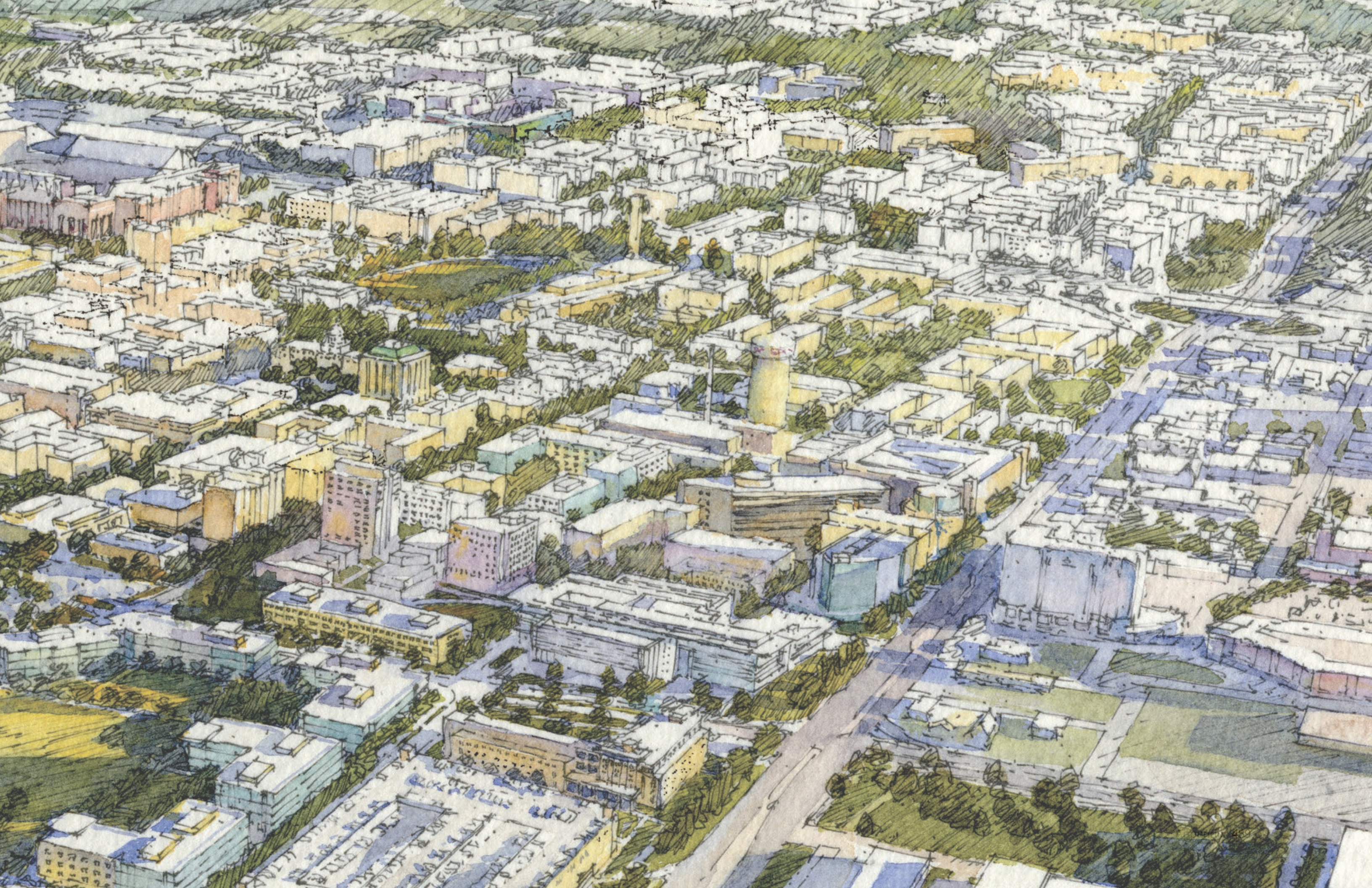

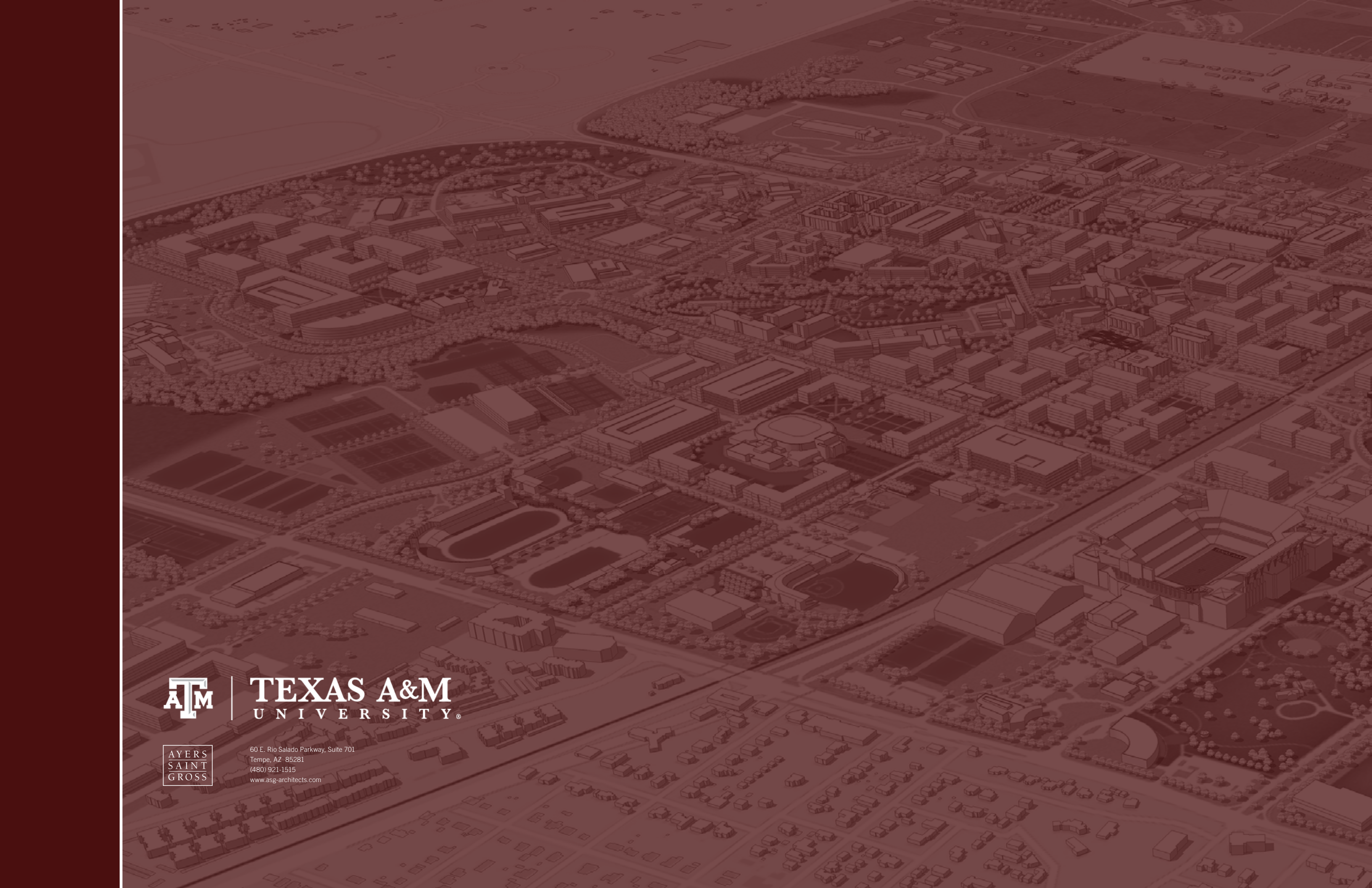

TEXAS A&M
UNIVERSITY®

AYERS
SAINT
GROSS

60 E. Rio Salado Parkway, Suite 701
Tempe, AZ 85281
(480) 921-1515
www.asg-architects.com